



LIGHT DECORATIONS
LIGHTING CHRISTMAS TREE DECORATION

DEKORACJE ŚWIETLNE
OŚWIETLENIE CHOINKI OZDOBY

■ ***POLAMP***

2020

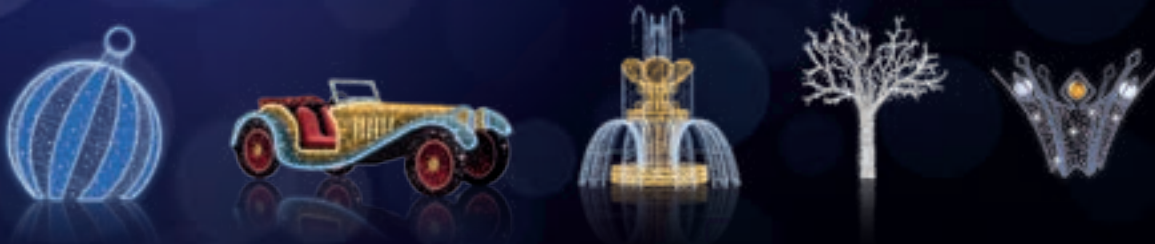

From the very beginning of POLAMP corporation, which is about several dozen of years, we provide electrical supply, including illumination. **We are the biggest polish producer of lighting decorations and christmas illuminations.** In our catalogue you can find several hundred of products inspired by our childhood fantasies and the charm of Christmas.

Christmas illumination has been the basis of our offer for years, since we are one of the biggest (a leader in) producers of illumination. We manufacture it with great passion providing 4 collections: brown - interior, silver - all-purpose, gold - exterior, green - with voltage limited to 24V. We offer several hundred models of illumination. Majority of our production are LED christmas lights. Furthermore, we produce illuminated curtains, nets, meteors, garlands and rope lights. For a couple of seasons a „must have” in our offer is a projector, which displays various animations and ornaments, not only during Christmas, but on different occasions.

Sometimes light sources don't have to be the only decorations. We produce christmas illuminations, which we have over 400 in our offer. The biggest array are christmas trees, from small and traditional to huge models with animated illumination and sets of decorations. There is a similar choice among garlands. Artificial christmas trees can be adorned with solid and unbreakable PCV decorations made by POLAMP brand. We also offer projectors with many creative projects of building illumination. You can buy a base, or a fully adorned artificial christmas tree. You may also be interested in plywood decorations.

Another offering on Christmas are illuminations. We prepared more than 1000 unitary propositions and whole sets. There are many exterior illumination arrangements, which we design, mount and maintain for public squares, parks, streets etc. We use modern technology, from flat, two-dimensional decorations to detached 3D giants in which you can take a photo. Various models of illuminations with marvellous colouring and light effects are suitable for bells and lanterns.

We offer bargain prices. We have our own sales coverage and advanced logistic centre in Giżycko. Aluminium chassis has a lifetime warranty and electrical components - 24 months. We provide free shipping with our own transport. We handle all the installation and dismantling of our illuminations. It is also possible to rent a certain decoration and to warehouse it during the rest of the year. We can also take care of the maintenance and repair. We design decorations along with visualisation on the building or other space. Our customers are individual clients, companies, city and bara councils.

Od początku istnienia spółki POLAMP, czyli już kilkadziesiąt lat, zajmujemy się asortymentem elektrycznym, w tym oświetleniem. **Jesteśmy największym polskim producentem dekoracji oświetleniowych i iluminacji świątecznych.** W ofercie mamy kilkaset produktów inspirowanych marzeniami z lat dziecięcych i urokiem świąt Bożego Narodzenia.

Oświetlenie świąteczne jest podstawą naszej oferty od lat, z racji bycia jednym z największych producentów źródeł światła. Tworzymy je z wielką pasją w ramach 4 kolekcji: brązowej - do wnętrz, srebrnej - uniwersalnej, złotej - typowo na zewnątrz, zielonej - o obniżonym napięciu do 24V. Oferujemy kilkaset modeli różnego rodzaju oświetlenia. Najwięcej produkujemy lampek choinkowych LED. Ponadto logiem POLAMP sygnujemy kurtynki, kurtyny oraz siatki, meteorki, węże świetlne i girlandy na żarówki. Od kilku sezonów obowiązkową pozycją w ofercie jest projektor, umożliwiający wyświetlanie rozmaitych ornamentów, animacji, nie tylko na Boże Narodzenie.

W wielu rozwiązaniach źródła światła nie są jedyną ozdobą. Produkujemy także dekoracje świąteczne. Mamy ich ponad 400. Największą grupą są choinki od małych tradycyjnych po gigantyczne stożki z animowanym światłem i gotowymi zestawami ozdób. Podobnie jest w przypadku girland. Sztuczne drzewka oraz przewieszki mogą być dekorowane nietłukącymi i odpornymi na warunki atmosferyczne ozdobami PCV marki POLAMP. Oferujemy także projektory z wieloma kreatywnymi możliwościami oświetlania budynków. Sprzedajemy bazę, np. sztuczną choinkę tradycyjną, ale też gotowe zestawy z oświetleniem i bombkami, czy innymi ozdobami. Warto wspomnieć o dekoracjach ze sklejki.

Trzecią propozycją na Święta są iluminacje. Przygotowaliśmy już ponad 1000 propozycji jednostkowych, jak i w zestawach. Świetlne aranżacje przestrzeni zewnętrznej, jakie m.in. projektujemy, montujemy, serwisujemy dla zarządców większych placów, ulic, parków... Stosujemy tu nowoczesne rozwiązania, od konstrukcji płaskich po wolnostojące giganty 3D, w których wnętrzu można zrobić sobie zdjęcie. Iluminacje przeznaczone są, w zależności od modelu, na elewacje i latarnie. Wszystko w niesamowitej kolorystyce, z efektami świetlnymi, animacjami itd.

Oferujemy konkurencyjne ceny. Dysponujemy własną siecią sprzedaży oraz nowoczesnym centrum logistycznym w Giżycku. Dajemy dożywotnią gwarancję na stelaż aluminiowy, 24 miesiące gwarancji na komponenty elektryczne. Oferujemy dostawę własnym transportem. Wykonujemy montaż i demontaż naszych ozdób. Istnieje możliwość wypożyczenia dekoracji, a w ciągu roku magazynowanie ich. W razie potrzeby wykonujemy niezbędne naprawy. Z przyjemnością projektujemy dekoracje wraz z wizualizacją wyglądu ozdobionej przestrzeni. Kompleksowo lub na dowolnym etapie, obsługujemy inwestycje. Naszymi Klientami są osoby prywatne, firmy i urzędy miast oraz gmin.

SPECIALIZED LIGHT DECOR / PROFESJONALNE ILUMINACJE	005	SNOWFLAKES, STARS / ŚNIEŻYNKI, GWIAZDY	174
DECORATION TYPES / RODZAJE DEKORACJI	006	ROSETTES / ROZETY	177
3D DECORATIONS / DEKORACJE 3D	012	BOWS & RIBBONS / KOKARDY I WSTĄŻKI	178
GIANT PRESENTS / PREZENTY GIGANTY	012	DISPLAY WINDOW DECOR / RAMY DO WITRYN	179
GATE MADE OF PRESENTS / BRAMA Z PREZENTÓW	014	ATYPICAL DECORATIONS / DEKORACJE NIETYPOWE	180
GIANT SNOWFLAKES / ŚNIEŻYNKI GIGANTY	016	FIGURES, TREES, STARS / FIGURY, DRZEWKA, GWIAZDY	180
GLOBES / KULA ZIEMSKA, GLOBUS	018	OPTICAL PET FILM DECORATIONS / FIGURY Z FOLI OPTYCZNEJ	181
GIANT CHRISTMAS BALLS / BOMBKI GIGANTY	019	BAUBLES AND GIANT PVC STARS / BOMBKI I GWIAZDY PCV GIGANTY	182
GIANT CHRISTMAS BALLS WITH PASSAGE / BOMBKI GIGANTY Z PRZEJŚCIEM	024	LED TECHNOLOGY / TECHNOLOGIA LED	184
GIANT STARS / GWIAZDY GIGANTY	028	SUPER-CONNECT TECHNOLOGY / TECHNOLOGIA SUPER-POLĄCZENIE	185
ANGELS / ANIOŁY	030	DECORATION TYPES / RODZAJE DEKORACJI	186
FRAMES / RAMY, MONIDŁA	031	INSTALLATION, ACCESSORIES / MONTAŻ, AKCESORIA	189
REINDEERS, REINDEER TEAMS / RENIFERY, ZAPRZĘGI	032	TIG TECHNOLOGY, PAINTING / TECHNOLOGIA TIG, MALOWANIE	190
SLEDGES / SANIE	034	DECORATION STRUCTURE, MICROCONTR. / BUDOWA DEKORACJI, PROGRAMATOR	191
FIGURES FROM THE STORY / POSTACIE Z BAJEK	036	EXAMPLE DESCRIPTIONS OF DECORATIONS / PRZYKŁADOWE OPISY DEKORACJI	192
ANIMALS / ZWIERZĘTA	037	VISUALISATION / WIZUALIZACJA	194
SANTAS / MIKOŁAJE	038	ILLUSTRATIVE INSTALLATION / PRZYKŁAD ZASTOSOWANIA	195
SNOWMEN, IGLO / BAŁWANY, IGLO	042	CHRISTMAS TREES, GARLANDS / CHOINKI, GIRLANDY	197
SNOWMEN, MUSICAL INSTRUMENTS / BAŁWANY, INSTRUMENTY MUZYCZNE	043	DESCRIPTION / OPIS	198
TEDDY BEARS / MISIE	044	GIANT CONES - HEIGHT / STOŻKI GIGANTY - WYSOKOŚĆ	200
CARRIAGES, HORSE TEAMS / KAROCE, ZAPRZĘGI	046	DECORATED CHRISTMAS TREES / CHOINKI Z DEKORACJĄ	201
THRONES, SWING / TRONY, HUŚTAWKA	048	GIANT CONES / STOŻKI GIGANTY	201
CHRISTMAS BALLS WITH A CHAIR / BOMBKI Z SIEDZISKIEM	049	GIANT CONES WITH RGB MODULES / STOŻKI GIGANTY Z MODUŁAMI RGB	227
SAILING SHIP, SAILS / ŻAGLOWIEC, ŻAGLE	050	GIANT CONES WITH PASSAGE / STOŻKI GIGANTY Z PRZEJŚCIEM	228
CHOO-CHOO / CIUCHCIE	052	VICTORIA - A GIANT CHRISTMAS TREE / CHOINKA VICTORIA	230
CARS / SAMOCHODY	054	CHRISTMAS TREES TYPES/ RODZAJE CHOINEK	232
AIRPLANE, TANKS / SAMOLOT, CZOŁGI	056	MIG/MAG WELDING TECHNOLOGY / SPAWANIE, CYNKOWANIE, RODZAJE IGLIWA	233
BALOONS / BALONY	058	CONSTRUCTION OF THE CONE / BUDOWA STOŻKA	234
WATERMILL, MERRY GO ROUND / MŁYN WODNY, KARUZELA	060	LIGHT AND PVC DECORATIONS / DEKORACJE ŚWIETLNE I Z PCV	236
COLUMNS, COPING / KOLUMNY, KOLUMNY ZE SKLEPIENIEM	062	TYPES AND THE NUMBER OF LIGHTS / ILOŚĆ OŚWIETLENIA I RODZAJE LAMPEK	238
LANTERNS / LAMPY OZDOBNE	062	TYPES OF PVC ORNAMENTS / RODZAJE OZDÓB Z PCV	239
EAGLES, LANCER, FLAGS / ULAN, ORZEŁ, FLAGI	064	ASSEMBLY OF THE CONE / SPOSÓB MONTAŻU STOŻKA	240
EAGLES, FLAGS / ORZEŁ, FLAGI	065	GARLANDS AND SMALL XMAS TREES / GIRLANDY I MAŁE CHOINKI	244
ICE REALMS / LODOWE KRAINY	066	ORNAMENTS: PVC, STYROFOAM / OZDOBY Z PCV, STYROPOLIANU	245
CHRISTMAS MUSIC BAND / ŚWIĄTECZNY ZESPÓŁ MUZYCZNY	067	SMALL XMAS TREES, DECORATED / CHOINKI MAŁE Z DEKORACJĄ	246
SANTA CLAUS' ARMCHAIR / FOTEL MIKOŁAJA	067	GARLANDS, DECORATED / GIRLANDY Z DEKORACJĄ	248
CHRISTMAS CRIBS / SZOPKA	068	FIGURES, 3D ANIMATED / FIGURY ANIMOWANE 3D	250
LETTERINGS / NAPISY	070	XMAS MARKETS / JARMARKI	251
LETTERINGS WITH PASSAGE / NAPISY Z PRZEJŚCIEM	072	DECORATIONS - COLLECTIONS / DEKORACJE - KOLEKCJE	252
PASSAGES, TUNNELS, GATES / PRZEJŚCIA, TUNELE	074	CHRISTMAS ILLUMINATIONS / OŚWIETLENIE ŚWIĄTECZNE	278
FOUNTAINS / FONTANNY	082	4 PRODUCT LINES / 4 LINIE PRODUKTÓW	280
MISCELANEOUS / RÓŻNE	095	LED STRING LIGHTS / LAMPKI LED	282
TREES COMPOSED OF SPHERES / DRZEWA Z KUL	096	LED STRING LIGHTS 24V / LAMPKI LED 24V	287
CHRISTMAS TREES/ CHOINKI	097	LED STRING LIGHTS - SUPER DENSE / LAMPKI LED SUPER GĘSTE	288
TREES / DRZEWA	100	SOLAR LED STRING LIGHTS / LAMPKI Z PANELEM SŁONECZNYM LED	289
SPHERES / KULE PODWIESZANE	102	LED BALL STRING LIGHTS / LAMPKI LED KULKI	290
STARS, SPHERES / KULE, GWIAZDY	103	LED BIG BALLS STRING LIGHTS / LAMPKI LED KULE BOMBY	291
CHALICES, PALMS / KIELICHY, PALMY	104	LED STRING LIGHTS - ORNAMENTS / LAMPKI LED Z ORNAMENTEM	292
CYLINDERS WITH ORNAMENT / WALCE Z ORNAMENTEM	107	TEARS STYLED LED LIGHTS / LAMPKI LED ŁEZKI	294
SHADES / LAMPIONY	112	LED RATTAN AND WOOL BALLS / KULKI RATANOWE I BAWELNIANE	296
SHADES, CROWNS / LAMPIONY, KORONY	114	LED WOODEN DECORATIONS / OZDOBY DREWNIANE LED	298
CHANDELIERS / ŻYRANDOLE	115	LED ROPE LIGHT REINDEER / RENIFER Z WĘŻA LED	301
MULTI	118	LED SNOW FLAKE / ŚNIEŻYNKA LED	301
OVERHANGS / PRZEWIESZKI	120	ICICLE LED CURTAINS / KURTYNKI LED	302
OVERHANGS WITH SIGNS / PRZEWIESZKI Z NAPISAMI	138	ICICLE LONG LED CURTAINS / KURTYNKI DŁGIE LED	306
ARCHES / ŁUKI	139	ICICLE VERY LONG LED CURTAINS / KURTYNKI BARDZO DŁGIE LED	307
FOLKSY OVERHANGS / PRZEWIESZKI LUDOWE	142	ICICLE STAR LED CURTAINS / KURTYNKI GWIAZDKI LED	307
POLE MOUNTED DECOR / DEKORACJE LATARNIOWE	144	LED CURTAINS / KURTYNY LED	308
PANELS WITH ORNAMENT / PLANSZE Z ORNAMENTEM	144	WATERFALL LED CURTAINS / KURTYNY LED Z EFEKTEM WODOSPADU	325
WITH METEORITE SHOWER / Z METEORKAMI	146	LED NET LIGHTS / SIATKI LED	328
COMETS, SNOWFLAKES, STARS / KOMETY, ŚNIEŻYNKI, GWIAZDY	147	LED METEORS AND STALACTITES LIGHTS / METEORKI I STALAKTYTY LED	332
COMPOSITIONS / KOMPOZYCJE	148	LED AND BULB ROPE LIGHTS / WĘŻE ŚWIETLNE LED I ŻARÓWKOWE	336
WEDGES / ROŻKI	150	ACCESSORIES / AKCESORIA	346
CORNERS, MEDALLIONS / NAROŻNIKI, MEDALIONY	152	E27 LAMP GARLANDS / GIRLANDY NA ŻARÓWKI E27	350
CURTAINS WITH ORNAMENT / ZASŁONY Z ORNAMENTEM	153	MONSTRUM, WHITE PROJECTORS / PROJEKTORY MONSTRUM, WHITE	352
WITH PVC BAUBLES/ Z BOMBKAMI PCV	154	G45 LED COLOR BULBS / LAMPY LED G45 KOLOROWE	356
STARS, RIBBONS, SNOWFLAKES / GWIAZDY, SERPENTYNY, ŚNIEŻYNKI	156	LED MODULES AND STRIPS / MODUŁY I TAŚMY LED	358
W/O ROPE LIGHT / BEZ WĘŻA	158	ALL-PURPOSE DECORATIONS / UNIWERSALNE	161
PVC BAUBLE BASED / Z BOMBKĄ PCV	159	ANGELS / ANIOŁY	161
SYMMETRICAL / SYMETRYCZNE	160	VARIOUS / RÓŻNE	162
LED STRING LIGHTS / LAMPKI LED	282	BELLS, XMAS CHARACTERS / DZWONKI, POSTACIE Z BAJKI	165
LED STRING LIGHTS 24V / LAMPKI LED 24V	287	XMAS TREES, SNOWMEN / CHOINKI I BAŁWANY	166
LED STRING LIGHTS - SUPER DENSE / LAMPKI LED SUPER GĘSTE	288	COMPOUND DECOR / ZŁOŻONE	167
SOLAR LED STRING LIGHTS / LAMPKI Z PANELEM SŁONECZNYM LED	289	DECOR WITH MAT / DEKORACJE Z MATĄ	168
LED BALL STRING LIGHTS / LAMPKI LED KULKI	290	MEDALLIONS / MEDALIONY	170
LED BIG BALLS STRING LIGHTS / LAMPKI LED KULE BOMBY	291	GIANT FLAT BAUBLES / BOMBKI GIGANTY PŁASKIE	171
LED STRING LIGHTS - ORNAMENTS / LAMPKI LED Z ORNAMENTEM	292	CHRISTMAS BALLS / BOMBKI	172
TEARS STYLED LED LIGHTS / LAMPKI LED ŁEZKI	294		
LED RATTAN AND WOOL BALLS / KULKI RATANOWE I BAWELNIANE	296		
LED WOODEN DECORATIONS / OZDOBY DREWNIANE LED	298		
LED ROPE LIGHT REINDEER / RENIFER Z WĘŻA LED	301		
LED SNOW FLAKE / ŚNIEŻYNKA LED	301		
ICICLE LED CURTAINS / KURTYNKI LED	302		
ICICLE LONG LED CURTAINS / KURTYNKI DŁGIE LED	306		
ICICLE VERY LONG LED CURTAINS / KURTYNKI BARDZO DŁGIE LED	307		
ICICLE STAR LED CURTAINS / KURTYNKI GWIAZDKI LED	307		
LED CURTAINS / KURTYNY LED	308		
WATERFALL LED CURTAINS / KURTYNY LED Z EFEKTEM WODOSPADU	325		
LED NET LIGHTS / SIATKI LED	328		
LED METEORS AND STALACTITES LIGHTS / METEORKI I STALAKTYTY LED	332		
LED AND BULB ROPE LIGHTS / WĘŻE ŚWIETLNE LED I ŻARÓWKOWE	336		
ACCESSORIES / AKCESORIA	346		
E27 LAMP GARLANDS / GIRLANDY NA ŻARÓWKI E27	350		
MONSTRUM, WHITE PROJECTORS / PROJEKTORY MONSTRUM, WHITE	352		
G45 LED COLOR BULBS / LAMPY LED G45 KOLOROWE	356		
LED MODULES AND STRIPS / MODUŁY I TAŚMY LED	358		



SPECIALIZED LIGHT DECOR PROFESJONALNE ILUMINACJE

All-purpose/pole mounted decorations: star, snowflake, rosette, angel, bell
Dekoracje uniwersalno-laterniowe: gwiazdy, śnieżynki, rozety, anioły, dzwonki



Facade/pole mounted decorations
Dekoracje elewacyjno-laterniowe



Pole mounted 3D decorations
Dekoracje latarniowe 3D



PVC baubles and optical foil
Dekoracje z bombek PCV i folii optycznej



Over-the-street decorations
Przewieszki



Fountains and Xmas trees
Fontanny i choinki



3D DECORATIONS: tunnels, walkways, sailing ships, trains, buses, cars, tanks, balloons, airplanes, eagles, figure sets, chairs, carriages, bears, teddy bears, reindeers, sledges, snowmen, angels, nativity scenes, giant presents, giant baubles, globes, trees

Dekoracje 3D: tunele, przejścia, żaglowce, pociągi, autobusy, samochody, czołgi, balony, samoloty, zestawy figur, fotele, zaprzęgi, niedźwiedzie, renifery, sanie, bałwany, anioły, szopki, prezenty giganty, bombki giganty, globusy, drzewa



Decorative lighting illuminates and festoons an area or object, such as lampposts or buildings. We produce over a 1000 models of Christmas light decorations, which makes us one of the industry's leaders and helps us build customer loyalty.

Many cities and municipalities across Poland as well as companies, large and small, have chosen POLAMP's decorative lighting. We're equally committed to assisting individual customers by designing and producing smaller-scale decorations.

We'll be happy to customize the production process to meet your needs. We'd like to stress that durability is the core aspect of POLAMP products. The TIG welding technology ensures quality of connections and welded joints. We tailor our products to our customers' expectations. Upon request, we custom paint decorations in your desired colour or wrap the frame in double LED rope light.

We offer state-of-the-art 3D-style decorations, which prove to be customers' favorite every Christmas season. We also produce hanging, lamppost (also available in 3D), park, street, facade and module decorations.

Most of our decorative lights can be fitted with a mat which refracts the light, increases its luminosity and enhance their colours.

We guarantee our light decorations to produce an enchanting spectacle of light. We offer a wide selection of products, and guarantee their long lifetimes and high durability. We can provide installation equipment, such as brackets, strapping tensioners, steel straps, and plastic or steel cable ties. Brackets are always provided free of charge for any light decoration. The brackets can remain on the object outside the Christmas season, when decorations are removed. Once secured, they make future mountings a breeze.

We manage the production process from start to finish. Everything begins with an idea, which we turn into a full-fledged design project and further on help our customers' vision become a tangible reality.



All-purpose decorations

As the name suggests, POLAMP's all-purpose decorations have a wide range of applications. They work as well as facade ornaments as they do as freestanding, window, or street light decorations.

Our decorations come in 11 colour patterns (including multicolour and two styles of white). We manufacture over 300 types of all-purpose decorations.

These are primarily illuminated ornaments, made with LED rope or strip light affixed to a metal frame or profile. The largest group is stars, which come in a variety of shapes and sizes – from 50 to 150 cm in diameter. Another is snowflakes, with diameter ranging from 65 to 300 cm. Decorations with diameter exceeding 100 cm feature PVC ornaments (of our production) which fill in the LED-free spaces. We produce over 100 different styles of star and snowflake ornaments.

No Christmas is complete without a Christmas tree, so naturally, they comprise a large fraction of our offer – they are available in many colour schemes and either in traditional or suspended form.

We produce several dozen styles of Christmas trees: standard, enhanced with additional motifs (e.g. stars), or halved (for street lights).

LED rosette decorations and bauble ornaments, which are all available in multiple styles, are also popular with our customers. Additional shapes include: angels, bells, moons, gifts and candles.

Another category of all-purpose decorations is characters inspired by fairy tales and Christmas stories, e.g. Santa Claus, reindeers and snowmen. Some are available on mats – lined with additional LEDs, as in our bows and illuminated ribbons.

Funkcjami iluminacji są oświetlanie i udekorowanie przestrzeni lub obiektów takich jak latarnie, czy budynki. Produkujemy ponad 1000 najróżniejszych rozwiązań oświetleniowych na święta, co plasuje nas w grupie liderów i pozwala zyskać coraz większe zaufanie Klientów.

Iluminacje POLAMP instalują na swoim terenie miasta i gminy oraz małe i duże firmy. Z równie wielkim zaangażowaniem wspieramy prywatne pomysły, projektując i produkując ozdoby o mniejszych gabarytach.

Proces produkcji z miłą chęcią dostosujemy do Twoich oczekiwań. Po pierwsze ze swojej strony gwarantujemy solidną konstrukcję, będącą bazą dla większości większych i gigantycznych dekoracji POLAMP. Jakość połączeń i spoin uzyskujemy dzięki metodzie spawania z użyciem technologii TIG. Po drugie – wspomniane wymogi Klienta. Możemy pomalować konstrukcję farbą o wskazanym kolorze. Na życzenie zamawiającego oplatamy stelaże lub girlandy podwójnym węzłem LED.

W ofercie mamy najnowocześniejsze dekoracje 3D, bijące rekordy popularności z każdym kolejnym sezonem świątecznym. Oprócz nich tworzymy dekoracje wiszące, latarniowe uniwersalne, także w wariacie 3D, parkowe, uliczne, elewacyjne i modułowe.

Do większości świetlnych dekoracji marki POLAMP można dołączyć maty, które odbijają światło, wzmacniają jego jasność i potęgują efekty kolorystyczne.

Poza niezwykłym urokiem, efektywnością świetlną, bogactwem opcji, żywotnością, trwałością, posiadamy akcesoria ułatwiające montaż, jak uchwyty, napinarki do taśm, taśmy stalowe, opaski plastikowe i stalowe. Do każdej iluminacji oferujemy uchwyty. Tym samym można pozostawić je przy lampie na następną zimę, co znacznie skraca kolejny montaż.

Iluminacje tworzymy od początku do końca. Najpierw jest pomysł, potem przygotowujemy projekt. Na końcu wspieramy jego realizację lub realizujemy w całości zgodnie z ustaleniami między nami a Zamawiającym.

Dekoracje Uniwersalne

Dekoracje uniwersalne POLAMP, jak sama nazwa wskazuje, mają szerokie zastosowanie. Pasują do iluminacji świetlnych tworzonych na elewacjach, są wykorzystywane jako dekoracje wolnostojące w przestrzeni miejskiej lub ozdoba okien, mogą być mocowane na latarniach, itd.

W ofercie mamy 11 kolorów, w tym opcja multikolor i dwie barwy bieli. Samych produktów wytwarzamy ponad 300.

Oferujemy przede wszystkim świecące ozdoby, powstające z połączenia taśmy lub węża LED ze stalowym stelażem, czy profilem. Wśród nich główną grupą są gwiazdy o rozmaitych kształtach i w kilku rozmiarach, od 50 cm do 150 cm średnicy. Wiele form produkujemy też dla śnieżynek, które w naturze, jak wiemy, są niepowtarzalne. Średnica świetlnych płatków śniegu mieści się w widelkach od 65 do 300cm. Ponad 100-centymetrowe ozdoby, w wolnych od diod przestrzeniach swoich struktur, mają zamocowane ozdoby PCV, również produkowane w naszej firmie. W sumie gwiazd, jak i śnieżynek, jest u nas ponad 100 rodzajów.

Nie ma świąt bez choinki, więc liczną grupę stanowią właśnie te drzewka w kolorowych wersjach do powieszenia lub postawienia. Mamy ich kilkadziesiąt. Są pojedyncze, z dodatkowymi motywami, np. gwiazdkami lub widoczne tylko w połowie do mocowania, np. przy latarniach.

Zainteresowaniem Klientów cieszą się także rozety o kilkunastu wzorach i bombki w kilkudziesięciu formach. Ponadto produkujemy anioły, dzwonki oraz księżycy, prezenty, świeczki.

Podgrupę produktów w kategorii dekoracji uniwersalnych stanowią świetlne postacie inspirowane światem bajek i świątecznych opowieści. Zaliczyliśmy do nich Mikołaje, renifery i bałwanki. Niektóre dostępne są na matach, wówczas ich wnętrze wypełnione jest dodatkowymi kolorowymi diodami LED. Podobnie jest w przypadku kokard i świetlnych wstęg.

All-purpose/pole mounted decorations



POLAMP's decorative lighting made with aluminum profiles and LED rope lights can be installed in many ways; most, however, work especially well as pole mounted decorations. We recommend them for decorating historic districts' and areas with traditional-style architecture.

These decorations also fit into the all-purpose product category. Their unique property is that their shape can be adjusted to fit a particular street light's post or its, often spherical, light cover.

Stars, snowflakes or baubles can be symmetrically affixed on both sides of a street light. Falling stars, gifts, or shape compositions are affixed on a single side. Christmas tree silhouettes can be set up adjacent to street lights or be suspended from them.

A starry ribbon or symmetrical ornament may encircle the light cover, putting the lamppost's light source right in the middle of the ornament. Some towns prefer more light-hearted decorations, such as our sitting Santa.

The sight of our decorative lighting adorning the streets of many Polish towns brings us sheer delight. Likewise, they fill the hearts of their inhabitants with joy. We see children excitedly point at the glistening lights and adults, inspired, telling them Christmas tales. And that's what it's all about!

If you seek to bring the Christmas spirit to your town, contact us. We treat every customer like he or she is our favorite. In addition, we grant you a warranty of 24 months.

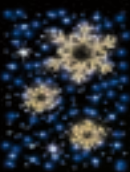

All-purpose/facade decorations

This category of LED decorations makes use of a light-reflecting mat, which produces impressive lighting effects. It boosts their luminosity and makes their colours more vivid.

They consist of an LED rope light affixed to an aluminum frame with anti-corrosion coating, skillfully welded by our experts. Upon request, we also give the decorations a coat of paint. Finally, the outline is fitted with additional LEDs: either static or blinking (FLASH).

These decorations are shaped like Christmas trees, stars, bows, gifts, angels, baubles and snowmen.



Pole mounted decorations

We have over 100 high-quality products in our pole mounted decorations product family. They bespangle the streets, market squares and plazas of many towns every year.

Stars & snowflakes, available in 11 colour patterns (including multicolour and two styles of white), are a tried and true choice.

The symmetrical decorations are mounted around the lamppost's light cover. Often expanded with meteorite shower or curtain modules, they are a popular choice of decorative street lighting.

The snowman is one of our favorites. One of the variants is mounted on the top part of the street light so that lamp is situated in the center of its belly. Alternate designs include the character climbing up the post or sitting on top of it.

Pole mounted decorations also include traditional stars, snowflakes, waves, angels, gifts, hearts and bows - illuminated with a LED rope light mounted on zinc plated aluminum frame. They can be affixed to the side of the lamp cover, suspended from it, or made to encircle it.

Make sure to also view our selection of wedge, corner and curtain type decorations. They are available in many arrangements and are fitted with static and FLASH LEDs.

Dekoracje Uniwersalno-laterniowe

Dekoracje oświetleniowe POLAMP wykonane z profili aluminiowych i (lub) ocynkowanych, z węży LED, mają powszechne zastosowanie, jednak część z nich doskonale nadają się do ozdabiania latarni. Dedykowane są przede wszystkim lampom stawianym w okolicach starówek i projektowanych w stylu starożytnym.

W naszej ofercie stanowią one znaczną część całej oferty świątecznych ozdób uniwersalnych. Wyróżniają się tym, że ich kształt można łatwo dopasować do słupa latarni ulicznej albo do którejś części zwykle kulistego klosza.

Po bokach latarni można powiesić symetrycznie standardowe gwiazdy, śnieżynki i bombki. Jednostronnie mocowane są spadające gwiazdy, prezenty, czy kompozycje form. Przy słupie stawia się lub wiesza połowy konturowych choinek.

Klosz może okalać opaska z gwiazd lub symetryczny ornament, w którego wnętrzu znajdzie źródło światła latarni. Miejsowości z większym poczuciem humoru mocują na lampach siedzące Mikołaje.

Cieszymy się, gdy widzimy nasze dekoracje, goszcząc w setkach polskich miast. Wielu przechodniom pojawia się uśmiech lub rozmarzenie na twarzy. Dzieci pokazują paluszkami na światelka. Dorośli opowiadają im świąteczne historie. O to właśnie chodzi!

Gdy chcesz wykorzystać potencjał i urok Świąt Bożego Narodzenia w swoim mieście, skontaktuj się z nami. Każde zamówienie traktujemy indywidualnie. Na produkty POLAMP otrzymasz od nas 24 miesięczne gwarancji.

Dekoracje Uniwersalno-elewacyjne

Dekoracje uniwersalne POLAMP elewacyjne to grupa oświetlenia LED wykorzystująca, jako tło efektu świetlnego - matę odbijającą światło. Dzięki temu rozwiązaniu jest ono jaśniejsze a w przypadku ozdób kolorowych - barwy są bardziej nasycone.

Dekoracje składają się z węży LED mocowanych na aluminiowych konstrukcjach pokrytych powłoką antykorozyjną. Są one profesjonalnie spawane przez naszych fachowców. Na życzenie Klienta także malujemy. Finalnie przygotowane kontury są wypełniane kolejnymi diodami, świecącymi światłem stałym lub błyskiem, tzw. efekt FLASH.

Projekty tych dekoracji inspirowane są kształtami choinek, gwiazd, kokardek, prezentów, aniołów, bombek i bałwanek.

Dekoracje Latarniowe

Dekoracje latarniowe POLAMP to ponad 100 produktów oświetleniowych wysokiej jakości, co roku dekorujących ulice, skwery oraz place polskich i zagranicznych miejscowości.

Standardem oferty są kompozycje gwiazd i śnieżynek, dostępne w 11 kolorach światła emitowanego przez diody LED, w tym multikolor i dwa odcienie bieli.

Dekoracje symetryczne z wybranymi ornamentami, montuje się wokół kloszy latarniowych. Przedłużone o meteorki, czy kurtynki, stanowią popularną dekorację przestrzeni miejskiej.

Jedną z naszych ulubionych ozdób świetlnych jest bałwanek, którego brzuszek może wypełniać klosz latarni. Inny wzór można przymocować tak, jakby wspinał się po lampie. Kolejny projekt to postać mogąca siedzieć na kloszu. Takie same opcje przygotowaliśmy w przypadku kształtu misia.

Następna grupa dekoracji latarniowych to powszechnie znane gwiazdy, śnieżynki i serpentyny, albo anioły, z węży LED owiniętych na aluminiowych i (lub) ocynkowanych profilach. Takie same możliwości montażu mają prezenty, serca i kokardy. W zależności od upodobań mogą być przytwierdzone do boku klosza, opasać go lub świecić pod nim.

Chcemy zwrócić Twoją uwagę na rożki, wykorzystujące rozmaite kształty a wypełnione diodami LED stałymi oraz z efektem FLASH. Poza rożkiem na takiej samej zasadzie projektujemy i wytwarzamy narożniki oraz zasłony.



Pole mounted/facade decorations

We produce several dozen item types intended for facade and street light decoration. As with many of our other products, they are available in 10 colours, including two types of white and multicolour.

One of the categories is ribbons, either default or ornamented. Second is arrangements of stars and snowflakes featuring a meteorite shower effect which imitates snow falling from the sky. Their animation is controlled with a remote controlled microcontroller. Third category comprises comets, which are colourful designs made with small and large ornaments. LED rope light unifies the individual parts into a whole. LED-free spaces are filled in with PVC ornaments available in red, silver or gold. Next up are stars and snowflakes, featuring an illuminated curtain of FLASH LEDs. There's also panels with stars, ribbons or Christmas trees, in which LEDs fill in decoration's entire surface. In ornamented windows, on the other hand, only the frame is illuminated.



Pole mounted 3D decorations

We have recently expanded our product family with 3D decorations, which, aside from standard features present in our decorations, that is their low power consumption, durability, efficiency, vivid colouration and different styles of illumination, provide an additional sense of depth.

The effect is achieved with specially shaped frame to which the LED rope light is affixed. They take form of illuminated ribbons which entwine the post. Other styles are based on Christmas tree shapes. The decorations are enhanced with PVC ornaments.

The MULTI variety of 3D decorations produces a beautiful spectacle of light. These decorations have a star-shaped cross-section and are assembled from several flat ornaments of the same type.

3D cylinders are ideal for large open spaces, such as squares or broad walkways. They're between 100 and 320cm tall and come in a variety of colours and may be embellished with PVC ornaments.

We also produce awe-inspiring 3D chalices, lanterns, crowns, chandeliers and shades.

They are available in 10 colours, including two types of white and multicolour.

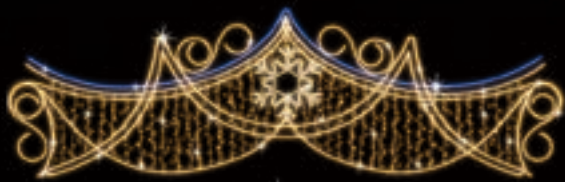

Composite over-the-street/facade decorations

This category comprises skyline decor, which is intended for decoration of the overhead space right above the street or on building facades.

The decorations are up to 600 cm wide. Some are simply a motif of LED lights, others feature additional ornamentation, such as PVC baubles. We can arrange a delivery for large shipments; they may be delivered disassembled and we'll assemble and install them on site.

Facade mounted panels are eye-catching facade decorations made with Xmas present and bauble ornaments and LED rope light, similar to star and snowflake variants. These decorations come with or without illuminated backdrop. Semicircles with ornaments are a different style, which works both as an over-the-street and facade decoration.

Dekoracje Latarniowo-elewacyjne

Dekoracje oświetleniowe POLAMP projektowane z myślą o iluminacji na elewacjach, czy przy latarniach, to gama kilkudziesięciu różnych produktów. Dostępne są w 11 kolorach w tym dwie barwy bieli oraz multikolor.

Należą do nich szarfy wieszane samodzielnie lub uzupełniane o różne ornamenty. Druga grupa dekoracji to wiszące kompozycje gwiazd i śnieżynek wzbogacone meteorkami, gdzie efekt spadającego światła imituje lecące z nieba płatki śniegu. Animacją można sterować dzięki specjalnemu programatorowi i zdalnemu pilotowi. Trzecia linia to komety, czyli kolorowe dekoracje składające się z małych i dużych ornamentów z dodatkami węży LED, których zadaniem jest połączenie poszczególnych elementów, z pomocą światła. Wolne przestrzenie wybranych modeli wypełnione są ozdobami PCV w kolorze: białym, srebrnym, złotym, czerwonym lub niebieskim. Trzeba wspomnieć o stosunkowo dużych śnieżynkach i gwiazdach, spod których zwisają kurtynki świetlne wykorzystujące efekt FLASH. Płata, a jednocześnie, niezwykle charakterystyczną grupą są plansze z gwiazdami, wstęgami, czy choinkami, wypełnione diodami LED w innym kolorze, niż wspomniane kształty. Podobne do nich są okna z ornamentem, z tą różnicą, że wypełniona jest jedynie rama.

Dekoracje Latarniowe 3D

Dekoracje oświetleniowe POLAMP składające się na iluminacje instalowane w wielu miejscowościach, to nie tylko energooszczędność, trwałość, wydajność, kolor, efekt błysku, czy spadającego światła.

Od kilku sezonów na rynek weszły ozdoby z trzecim wymiarem. Wrażenie 3D osiągamy dzięki kształtowi stelaży, na których mocujemy węże LED. Są to bardzo często świetlne serpentyny, okręcające się wkoło pionowego słupka lub latarni. Dodatkowo wkomponowaliśmy w konstrukcję nasze ozdoby PCV. Poza klasyczną formą okręconej wstążki produkujemy też ozdoby inspirowane kształtem choinek.

Niesamowitych wrażeń estetycznych dostarczają ornamenty multi. Powstają one z połączenia na bazie gwiazdy kilku tych samych płaskich ornamentów, zyskując w efekcie figurę przestrzenną.

Imponujące i przeznaczone do szerokich przestrzeni ulic, deptaków, czy placów, są walce 3D wysokie na 100 do 320 cm. Zdobi się nimi klosze i słupy lamp oświetleniowych. Produkujemy je w różnych kolorach, ale także z dodatkami ozdób PCV.

Trzecia grupa w asortymencie dekoracji to wspaniałe połyskujące, wypełnione diodami kielichy 3D. Na takiej samej zasadzie, jak walce i kielichy, mocowane są lampiony, korony, żyrandole i klosze.

Światło emitowane przez diody LED wykorzystywane w omawianych dekoracjach, oferujemy w 10 wariantach kolorystycznych, w tym w multikolorze.

Dekoracje Uliczno-Elewacyjne złożone

Świetlne dekoracje przeznaczone na ulice, czy na elewacje to przede wszystkim przewieszki POLAMP, np. połączone ze sobą gwiazdy, serpentyny i śnieżynki.

Rozpiętość dekoracji sięga 600 cm. W zależności od modelu, przewieszki składają się wyłącznie z diod LED, inne dodatkowo z ornamentów, czy bombek PCV (w kol. białym, srebrnym, złotym, czerwonym lub niebieskim). Rozmiary ozdoby nie są przeszkodą w transporcie, ponieważ przy dużych zamówieniach zapewniamy Klientom usługę transportową. Możemy je dostarczyć w częściach, a potem zmontować i powiesić w ustalonym miejscu.

Efektowne konstrukcje tworzą plansze na elewacje, składające się z prezentów, bombek, z profili i węży LED, podobnie gwiazdy, czy śnieżynki. Wszystkie dostępne ze świetlnym wypełnieniem lub bez. Nie można ominąć półkoli z ornamentami do ozdabiania fasad budynków, czy powieszania nad ulicami.

Ozdoby wykorzystują wszystkie opcje świecenia, jakie mają diody LED używane w naszych produktach. Mamy zatem błysk albo efekt spadających światełek, podkreślony dzięki zastosowaniu kurtyn LED. Te właśnie stanowią drugą grupę asor-

These light decorations feature all types of LED lighting used in our products, e.g. shimmer or meteor rain, which are especially visually stunning in our LED curtains. Our largest curtain piece measures 150 x 700 cm.

The curtains, which take form of shimmering blanket of LED string lights, provide a stunning and unique spectacle of light which differs from that produced by our standard over-the-street ornaments.

Make sure to look at our signs, available in multiple languages. The most popular variants spell classic Christmas greetings, such as „Merry Christmas”. The largest sign spans 800 cm.

We also recommend our gates, which resemble a drawn curtain. They measure 500 x 600 cm.

We deliver and, if needed, can assist with the assembly, restoration, repair and even out-of-season storage of products you have bought from us. We also give you all the benefits of manufacturer's warranty.



All-purpose 3D decorations

This category comprises a group of over 250 various three-dimensional decorations. They are intended for both posts and facades.

Giants are the most popular sub-category in this collection. They are massive, colourful arrays of LED lights fashioned into shapes of baubles, gifts and stars. They festoon town squares, plazas and walkways and are often situated in front of municipal buildings or malls.

Walk-through 3D decorations are a fantastic choice as well. They give passers-by an opportunity to directly interact with the decoration and are perfect for festive snapshots. Ideal for children, they are bound to awake a playful, childlike spirit of Christmas time in adults as well.

All of the aforementioned light decorations are made with LED lights. Smallest bauble-shaped ornaments have a diameter of 200 cm. Largest - 490 cm. Gifts: for spherical base the diameter ranges from 60 cm to 490 cm; rectangular base - 300 x 200 cm. Stars, depending on type, can either span 300 cm in diameter (spark variant) or measure up to 50 x 200 cm (flat-faced variant).

We also make 3D LED rope light decorations. They consist of two LED planes combined to create an effect of depth. We produce deer, Christmas tree, angel and bear shaped illuminated figures in this category. Their dimensions range from 80 to 200 cm.

We'll be happy to deliver our giants to your chosen location and assist in their installation and maintenance. We give our customers all the benefits of manufacturer's warranty.



3D figures

Our three-dimensional decorations inspired by classic Christmas characters festoon the streets of hundreds of towns.

We produce angels playing musical instruments: trumpet, harp or violin. There's also reindeers, sleds, Santa Claus, igloos and snowmen (either in white or colourful theme).

Our nativity scene decorations produce a magical effect. The basic set can be expanded with additional characters and animals mentioned in the Bible. They're a perfect ornamentation for town's historical districts and look stunning outside of churches and sanctuaries. Bison, moose or swans aren't restricted to Christmas season and can be displayed all year round.

A distinct type of 3D light decor is produced by merging two planes. Trumpet-playing angels and various animals are available in this style.

tymentu dekoracji uliczno-elewacyjnych. Największy dostępny wymiar jednego kompletu to 150x700 cm.

Na bazie bogatej oferty wiszących sznurów ze źródłami światła LED, powstają bajeczne kompozycje efektów świetlnych i świecących ornamentów. Są one odmienne w swej formie od kształtów profili z kolorowymi węzami LED. Bardzo urozmaicone przewieszki, choć oparte na tych samych formach, są głównymi elementami zestawów dekoracyjnych o przeznaczeniu typowo urbanistycznym.

Odrębna grupa to napisy, w kilku językach, najczęściej z popularnymi życzeniami, typu Wesołych Świąt. Najdłuższy napis ma 800 cm.

Pełne uroku są bramy, przypominające odsłonięta kurtynę w teatrze, czy zasłone podwieszoną po bokach okna. Wymiary takiej ozdoby to 500x600 cm.

Jak wspomnieliśmy, oferujemy transport produktów POLAMP. Dodatkowo możemy zająć się montażem, renowacją, naprawą, a nawet przechowaniem poza sezonem świątecznym. Dajemy gwarancje producenta na nasze dekoracje uliczno-elewacyjne.

Dekoracje Uniwersalne 3D

Dekoracje uniwersalne 3D marki POLAMP to grupa ponad 250 rozmaitych przestrzennych kształtów i figur, ale też płaszczyzn. Uniwersalne, czyli do ozdoby zarówno elewacji, jak i latarni.

Najbardziej popularne są tzw. giganty. Są to wielkogabarytowe, kolorowe, wypełnione światłkami bombki, prezenty i gwiazdy. Nasze olbrzymy lokowane są na płytach zabytkowych rynków, przy urzędach gmin i miast, przed galeriami handlowymi, na placach i szerokich deptakach.

Największym sukcesem okazały się przestrzenne bryły z przejściami. W ich wnętrzach przechodnie pozują do zdjęć, bawią się w chowanego lub przelotem wręcz - w gonionego. Jest to wcieleństwo dziecięcych fantazji, realizacja świątecznej krainy czarów. Niesamowita przestrzeń, w której zatrzymuje się czas i nawet ludzie z większym peselem stają się dziećmi.

Wymienione propozycje wykonujemy z lampek LED. Najmniejsze bombki mają średnicę 200 cm a największe - 490 cm. Najmniejszy prezent na planie koła ma średnicę 60 cm, największy także 490 cm. Na planie prostokąta 300x200 cm. Gwiazda w zależności od kształtu konstrukcji ma średnicę 300 cm a największe wymiary 50x200 cm.

Produkujemy również ozdoby z węża LED. Są to dwie płaszczyzny połączone ze sobą w odpowiednim odstępnie. Dzięki temu prostemu zabiegowi otrzymujemy efekt trójwymiarowości. Oferujemy w tej grupie jelonka, choinkę, anioła i niedźwiedzia. Wszystkie wymiary bryły tych dekoracji mieszczą się w granicach 80 do 200 cm.

Z przyjemnością pomożemy Tobie w transporcie gigantów na miejsce ich postawienia. Co więcej, montujemy i serwisujemy asortyment POLAMP. Ponadto dajemy gwarancję producenta.

Dekoracje 3D Figury

Przestrzenne dekoracje POLAMP inspirowane świątecznymi postaciami, stoją w setkach miejscowości.

Wśród nich są anioły grające na trąbach, harfie, czy skrzypcach. Zgodnie z zachodnimi trendami, zaprojektowaliśmy świecące renifery i obowiązkowo - sanie. Jest też powożący, czyli kolorowy Mikołaj we własnej powszechnie znanej postaci. Nie unikamy innych tematów jak igloo oraz bałwany w wersji białej i kolorowej.

Imponującą dekoracją są szopki bożonarodzeniowe ze Świętą Rodziną. Mogą być rozbudowane o inne postaci i zwierzęta wymieniane w Piśmie Świętym. Wspaniale sprawdzają się na starówkach, przy kościołach, sanktuariach.

Ukłonem w stronę iluminacji całorocznych lub do umieszczenia w charakterystycznych miejscach, są żubr, łoś, czy łabędź.

Inną konstrukcją 3D jest połączenie dwóch płaszczyzn. W tym segmencie proponujemy wysokie anioły grające na trąbie oraz zwierzęta.

These animal- and human-shaped decorations are bound to impress anybody with their wondrous display of light and fantastical appearance.

We don't merely sell our decorations - call us to arrange delivery, installation and maintenance of our decorations. Warranty included.



3D fountains

POLAMP offers over 20 distinct products in this category. These include decorations for existing fountains or standalone fountain-shaped illuminations which are bound to wonderfully embellish any town plaza.

As we all know, traditional fountains are disabled for winter time. Thanks to our decorations, they can shine even in sub-zero temperatures.

One of the more interesting variants is the illuminated fountain topped with a hovering light sphere. The sphere is available in various styles: starry, snowy or moon/planet-like.

Light fountain in star pattern is also an interesting choice. It produces an illusion of ribbons of light flowing from the center of the fountain. These fountains are mounted on an aluminum post.

Fountains featuring a LED meteorite shower effect mimic water pouring into fountain's basin or in jets into the air. Available in styles of circular base or illuminated chalice.

An unusual variant is the tree-shaped fountain. Its branches can even be adorned with additional ornaments, such as baubles. This choice is very popular with our clients.

Lastly, we offer to transform any street light into a fancy-shaped fountain, which is bound to turn heads after nightfall. These decorations are affixed to post's base and don't reach the light cover.

Fountains are available in 10 colours, including multicolour. Largest fountain measures 1000 x 950 m.

We'll be happy to deliver our 3D fountains to your chosen location and assist in their assembly and maintenance. We give our customers all the benefits of manufacturer's warranty.



3D Xmas Trees, regular trees

3D decor is the newest addition to our selection of festive decorative lighting. These state-of the art products prove that spectacular light decorations can also be energy efficient.

Tree decorations and Xmas trees are available in 11 colours, including multicolour. They can be found throughout many cities and towns; on plazas, in front of commercial buildings and inside of malls.

3D Xmas trees come in three variants: cone, pyramid and ribbon. They are mounted on an aluminum frame and are feature an illuminated star topper. Smallest tree has dimensions of 200 x 75 cm; largest - 1000 x 400 cm. Available upon request.

Light sphere Xmas tree is a very original alternative to classic trees. Such tree measures 600 x 300 cm. They are as perfect in bringing festive atmosphere to various places as their traditionally shaped cousins. Available upon request.

We give our customers all the benefits of manufacturer's warranty. We deliver and, if needed, can assist with the assembly and maintenance of our Xmas trees and tree decorations.

Podsumowując, dzięki świetlnym wyobrażeniom, ludzi, istot, zwierząt, możesz stworzyć niesamowitą iluminację ożywiająca przestrzeń po zmroku, uruchomić wyobraźnię przechodniów, zachwycić gości.

U nas nie tylko kupujesz. Możesz liczyć na pomoc w transporcie, montażu a w przyszłości - w serwisowaniu całego asortymentu zakupionego u dystrybutorów POLAMP. Gwarancja producenta w pakiecie.

Dekoracje 3D Fontanny

Oferujemy ponad 20 zestawów świetlnych 3D marki POLAMP. Wśród nich komplety do dekoracji istniejących fontann, albo zupełnie nowe formy inspirowane kształtem działającej fontanny, do zagospodarowania placu, czy skweru.

Dzięki temu kreatywnemu pomysłowi, stary nudny obiekt, w lecie aktywny dzięki wodzie, zimą ma szansę dosłownie zablęsnąć. To jednak nie wszystkie możliwości instalacji.

Jedną z najciekawszych propozycji wśród wszystkich zimowych dekoracji, jest fontanna świetlna z efektem zawieszanej nad nią świecącej kuli. Produujemy takie kule, z gwiazdkami, śnieżynkami, czy imitującymi księżyc/planety.

Warto zwrócić uwagę na fontannę światła, na bazie gwiazdy, którą można postawić na każdej odpowiedniej wielkości powierzchni z wykorzystaniem aluminiowego słupa. Przechodzący ma wrażenie, jakby światło rozlewało się wstęgami na boki.

Podobnie do wcześniejszych modeli, fantastycznie prezentują się meteorki LED, nawiązujące swoim sposobem świecenia do spadającej lub tryskającej w górę wody. Mogą mieć podstawę z koła lub świetlnego kielicha.

Intrygującym rozwiązaniem wzbogacającym miejską iluminację jest fontanna przypominająca kształtem... drzewo. Taka roślinna z pnem i gałęziami może być nawet obwieszona bombkami, wzrósł ten jest wyjątkowo popularny wśród naszych zamawiających.

Wreszcie zwykła latarnia, jaką znamy z chodników, może stać się fontanną i zachwycać po zmroku. Dekorację montuje się od podstawy lampy, lecz w taki sposób, że nie sięga do klosza latarni.

Wszystko to dostępne jest w 11 kolorach LED i w wariacie multikolor. Największe gabaryty ma zestaw o wymiarach 1000x950 cm.

W razie potrzeby wesprzemy Cię w transporcie, montażu i serwisowaniu zakupionych u nas dekoracji 3D. Udzielamy też gwarancji producenta na asortyment marki POLAMP.

Dekoracje 3D Choinki, Drzewa

Dekoracje 3D są najmłodszym produktem POLAMP w ofercie oświetlenia świątecznego. Jest to nowoczesne, energooszczędne, a jednocześnie bardzo widowiskowe rozwiązanie.

Ozdoby drzew i choinki produkujemy w 11 kolorach LED i w wariacie multikolor. Wykorzystuje się je w przestrzeni miast i miasteczek, czy na placach przy budynkach komercyjnych, jak na terenie galerii handlowych.

Choinki 3D to wspierające się na aluminiowych stelażach stożki lub bryły zwężane ku górze o podstawie kwadratu albo układające się w serpentynę świetlne wstęgi. Czubek takiego drzewka zwieńczony jest oczywiście świecąca gwiazdą. Najmniejsza choinka ma wymiary 200x75 cm a największa 1000x400 cm. Produkty dostępne są na zamówienie.

Nietuzinkowym rozwiązaniem, sprawiającym niesamowite wrażenie jest choinka lub drzewo 3D ze świetlnych kul. Wymiary choinki 600x300 cm. Dzięki nim można wykreować świąteczny nastrój w miejscach, w których żywe lub sztuczne drzewko do dekoracji nie stanie. Produkty dostępne na zamówienie.

Dekoracje 3D objęte są oczywiście gwarancją producenta. Ponadto proponujemy wsparcie w transporcie, montażu i serwisowaniu choinek oraz drzew marki POLAMP.



3D DECORATIONS / DEKORACJE 3D

GIANT PRESENTS / PREZENTY GIGANTY



POL-1924M
od 60 do 500 cm
LED 50-700W



POL-1925M
od 60 do 500 cm
LED 50-700W



POL-1920M
od 60 do 500 cm
LED 50-700W



POL-0926M
od 60 do 300 cm
LED 60-400W



POL-0927M
od 60 do 300 cm
LED 60-400W



POL-0928M
od 60 do 300 cm
LED 60-400W



POL-1923M
od 60 do 300 cm
LED 100-700W



POL-1921
od 60 do 300 cm
LED 60-400W



POL-1922M
od 60 do 300 cm
LED 60-400W

Reaching up to several metres of height, giant presents composed of mats are perfect for filling large spaces of parks or squares. They can also serve as an extension of shops' entrances.

Kilnometrowe prezenty giganty na matach doskonale wypełniają duże miejskie przestrzenie jak parki czy place. Mogą też służyć jako przedłużenie wejść do sklepów.

Giant presents w/ passage often attract interest of passers-by. These decorations can be set directly on the pavement or squares.

Prezenty giganty z przejściem często wzbudzają ciekawość przechodniów. Można je stawiać bezpośrednio na chodnikach i placach.





AVAILABLE LED COLOURS / DOSTĘPNE KOLORY LED

cold white, neutral white, warm white, classic white, yellow, orange, pink, purple, red, blue, water blue, green, multicolor, RGB

biały zimny, biały neutralny, biały ciepły, biały klasyczny, żółty, pomarańczowy, różowy, fioletowy, czerwony, niebieski, niebieski morski, zielony, multikolor, RGB



POL-1926M
300x200 cm
LED835W

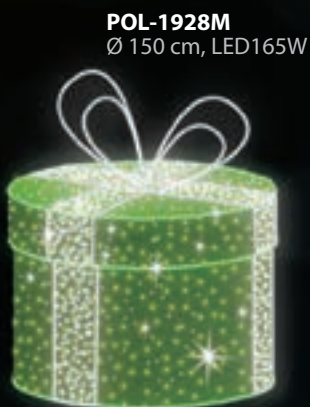

POL-1928M
Ø 150 cm, LED165W



POL-1927M
180x200 cm
LED550W



POL-1930M
180x100 cm, LED250W



POL-1931M
150x100 cm, LED165W



POL-1932M
Ø 100 cm, LED115W



POL-1929M
30x100 cm, LED115W



POL-2900
400x400x100 cm
LED500W



POL-2899
400x400x100 cm
LED300W

We offer giant presents both as separate decorations and sets consisting of a few presents. These sets are perfect for decorating squares, plus they can also act as an addition to giant Christmas trees.

Prezenty giganty oferujemy zarówno jako pojedyncze dekoracje jak i zestawy składające się z kilku prezentów. Zestaw kilku prezentów doskonale nadaje się do zdobienia placów a także jako uzupełnienie choinek gigantów.

AVAILABLE LED COLOURS / DOSTĘPNE KOLORY LED

cold white, neutral white, warm white, classic white, yellow, orange, pink, purple, red, blue, water blue, green, multicolor, RGB

biały zimny, biały neutralny, biały ciepły, biały klasyczny, żółty, pomarańczowy, różowy, fioletowy, czerwony, niebieski, niebieski morski, zielony, multikolor, RGB





POL-2902
od 100 do 500 cm
LED150-2000W



POL-2903
od 100 do 500 cm
LED150-2000W

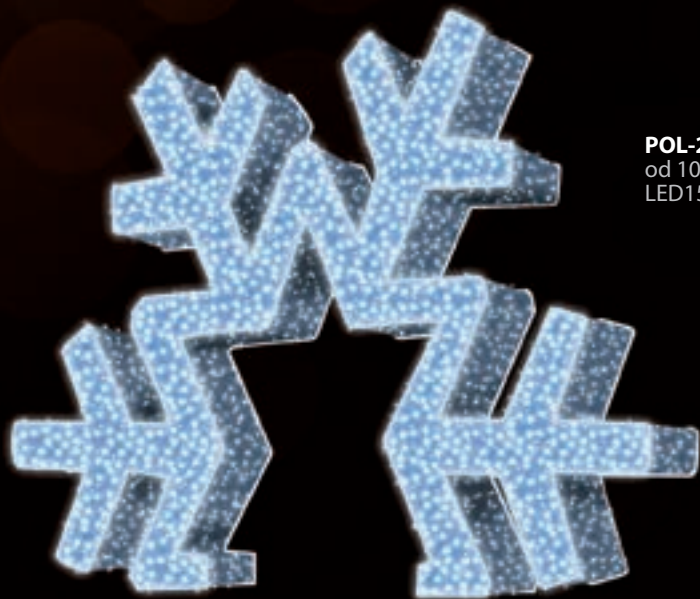

POL-2904
od 100 do 500 cm
LED150-2000W



POL-2905
od 100 do 500 cm
LED150-2000W

AVAILABLE LED COLOURS / DOSTĘPNE KOLORY LED

cold white, neutral white, warm white, classic white, yellow, orange, pink, purple, red, blue, water blue, green, multicolor, RGB

biały zimny, biały neutralny, biały ciepły, biały klasyczny, żółty, pomarańczowy, różowy, fioletowy, czerwony, niebieski, niebieski morski, zielony, multikolor, RGB





3D DECORATIONS / DEKORACJE 3D

GLOBES / KULA ZIEMSKA, GLOBUS



POL-0934M
Ø 300 cm
LED350W



POL-0935M
Ø 400 cm
LED675W



POL-0936M
Ø 500 cm
LED1724W

Colourful mats bring out the light and colours. These mats are useful when we want to create a concrete graphic, which is the outline of lands on the globe. It is also available in a transparent variant w/out the mats, just like any other 3D figures.

Kolorowe maty lepiej podkreślają kolory i światło. Są przydatne wszędzie tam gdzie chcemy pokazać konkretną grafikę. W tym wypadku zarys lądów na kuli ziemskiej. Podobnie jak wszystkie inne figury 3D dostępne są również bez mat w wersji „przezroczystej”.



3D DECORATIONS / DEKORACJE 3D
GIANT CHRISTMAS BALLS / BOMBKI GIGANTY



POL-2906
od 200 do 700 cm
LED 250/500/975/2000W

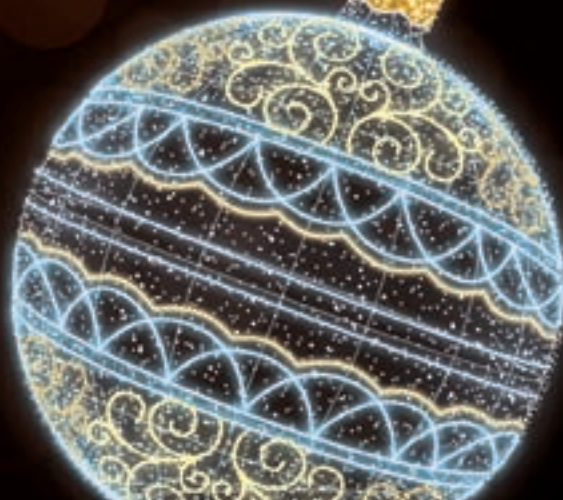

POL-2907
od 200 do 700 cm
LED 250/500/975/2000W



POL-2908
od 200 do 700 cm
LED 250/500/975/2000W



POL-2909
od 200 do 700 cm
LED 250/500/975/2000W

AVAILABLE LED COLOURS / DOSTĘPNE KOLORY LED

cold white, neutral white, warm white, classic white, yellow, orange, pink, purple, red, blue, water blue, green, multicolor, RGB

biały zimny, biały neutralny, biały ciepły, biały klasyczny, żółty, pomarańczowy, różowy, fioletowy, czerwony, niebieski, niebieski morski, zielony, multikolor, RGB



Giant baubles are also available in the version w/ colourful mats.

Bombki giganty podobnie jak wszystkie inne figury 3D dostępne są również w wersji z kolorowymi matami.



3D DECORATIONS / DEKORACJE 3D
GIANT CHRISTMAS BALLS / BOMBKI GIGANTY



POL-0924
Ø 200 / 300 / 400 / 490 cm
LED 220 / 430 / 880 / 1700 W

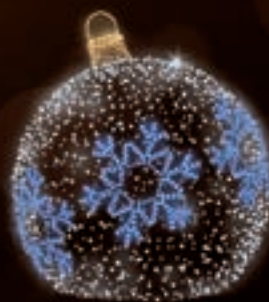

POL-1909
Ø 200 / 300 / 400 / 490 cm
LED 220 / 430 / 880 / 1700 W



POL-1910
Ø 200 / 300 / 400 / 490 cm
LED 220 / 430 / 880 / 1700 W



POL-1914
Ø 200 / 300 / 400 / 490 cm
LED 220 / 430 / 880 / 1700 W



POL-1980
Ø 200 / 300 / 400 / 490 cm
LED 220 / 430 / 880 / 1700 W



POL-1907
Ø 200 / 300 / 400 / 490 cm
LED 220 / 430 / 880 / 1700 W

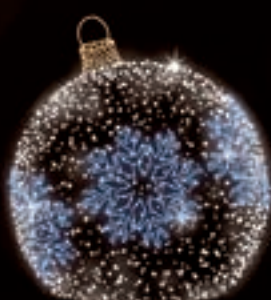

POL-1908
Ø 200 / 300 / 400 / 490 cm
LED 220 / 430 / 880 / 1700 W



POL-0925
Ø 200 / 300 / 400 / 490 cm
LED 220 / 430 / 880 / 1700 W

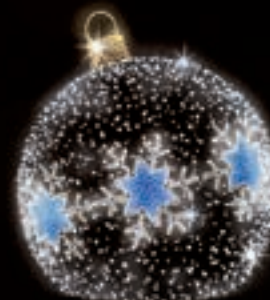

POL-1911
Ø 200 / 300 / 400 / 490 cm
LED 220 / 430 / 880 / 1700 W



POL-1912
Ø 200 / 300 / 400 / 490 cm
LED 220 / 430 / 880 / 1700 W



POL-1913
Ø 200 / 300 / 400 / 490 cm
LED 220 / 430 / 880 / 1700 W



POL-1904
Ø 200 / 300 / 400 / 490 cm
LED 220 / 430 / 880 / 1700 W



POL-1903
Ø 200 / 300 / 400 / 490 cm
LED 220 / 430 / 880 / 1700 W



POL-1901
Ø 200 / 300 / 400 / 490 cm
LED 220 / 430 / 880 / 1700 W



POL-1902
Ø 200 / 300 / 400 / 490 cm
LED 220 / 430 / 880 / 1700 W



POL-1905
Ø 200 / 300 / 400 / 490 cm
LED 220 / 430 / 880 / 1700 W



POL-1906
Ø 200 / 300 / 400 / 490 cm
LED 220 / 430 / 880 / 1700 W

Giant baubles reaching up to 5 metres (4,9 metres) of height are perfect for filling spaces of large squares, parks, and town squares. Their size and diversity of ornaments act as an eye catcher and attract attention of passers-by. These decorations are increasingly chosen by our customers.

Bombki giganty dochodzące do 5 m (4,9 m) wysokości doskonale wypełniają przestrzeń dużych placów, parków i miejskich rynków. Swoją wielkością i bogactwem ornamentów przyciągają wzrok przechodniów. Są coraz częściej wybierane przez naszych klientów.



AVAILABLE LED COLOURS / DOSTĘPNE KOLORY LED

cold white, neutral white, warm white, classic white, yellow, orange, pink, purple, red, blue, water blue, green, multicolor, RGB

biały zimny, biały neutralny, biały ciepły, biały klasyczny, żółty, pomarańczowy, różowy, fioletowy, czerwony, niebieski, niebieski morski, zielony, multikolor, RGB



3D DECORATIONS / DEKORACJE 3D
GIANT CHRISTMAS BALLS WITH PASSAGE
BOMBKI GIGANTY Z PRZEJŚCIEM



POL-2910
od 400 do 700 cm
LED 400/750/1200/1800W



POL-2911
od 400 do 700 cm
LED 400/750/1200/1800W



POL-2912
od 400 do 700 cm
LED 400/750/1200/1800W



POL-2913
od 400 do 700 cm
LED 400/750/1200/1800W

AVAILABLE LED COLOURS / DOSTĘPNE KOLORY LED

cold white, neutral white, warm white, classic white, yellow, orange, pink, purple, red, blue, water blue, green, multicolor, RGB

biały zimny, biały neutralny, biały ciepły, biały klasyczny, żółty, pomarańczowy, różowy, fioletowy, czerwony, niebieski, niebieski morski, zielony, multikolor, RGB





3D DECORATIONS / DEKORACJE 3D

GIANT CHRISTMAS BALLS WITH PASSAGE / BOMBKI GIGANTY Z PRZEJŚCIEM



POL-1915

Ø 200 / 300 / 400 / 490 cm
LED 170 / 330 / 660 / 1300 W



POL-1916

Ø 200 / 300 / 400 / 490 cm
LED 170 / 330 / 660 / 1300 W



POL-1917

Ø 200 / 300 / 400 / 490 cm
LED 170 / 330 / 660 / 1300 W



POL-1918M

Ø 200 / 300 / 400 / 490 cm
LED 170 / 330 / 660 / 1300 W



POL-1919M

Ø 200 / 300 / 400 / 490 cm
LED 170 / 330 / 660 / 1300 W



POL-1915B

Ø 200 / 300 / 400 / 490 cm
LED 170 / 330 / 660 / 1300 W



POL-0943

Ø 200 / 300 / 400 / 490 cm
LED 170 / 330 / 660 / 1300 W



POL-0944

Ø 200 / 300 / 400 / 490 cm
LED 170 / 330 / 660 / 1300 W

AVAILABLE LED COLOURS / DOSTĘPNE KOLORY LED

cold white, neutral white, warm white, classic white, yellow, orange, pink, purple, red, blue, water blue, green, multicolor, RGB

biały zimny, biały neutralny, biały ciepły, biały klasyczny, żółty, pomarańczowy, różowy, fioletowy, czerwony, niebieski, niebieski morski, zielony, multikolor, RGB



3D DECORATIONS / DEKORACJE 3D

GIANT STARS / GWIAZDY GIGANTY



POL-1935
50x150 cm, LED112W



POL-1933
30x100 cm, LED75W



POL-1934
50x200 cm, LED150W



POL-1973
Ø 300 cm,
LED498W



POL-1936
Ø 300 cm, LED498W





AVAILABLE LED COLOURS / DOSTĘPNE KOLORY LED

cold white, neutral white, warm white, classic white, yellow, orange, pink, purple, red, blue, water blue, green, multicolor, RGB

biały zimny, biały neutralny, biały ciepły, biały klasyczny, żółty, pomarańczowy, różowy, fioletowy, czerwony, niebieski, niebieski morski, zielony, multicolor, RGB



POL-0954M
300x400x150 cm
LED425W



POL-0955M
300x400x150 cm
LED450W



POL-0956
300x400x150 cm
LED415W





POL-1937
250x100 cm
LED120W



POL-0967
250x120 cm
350x135 cm
500x150 cm
LED120W
LED180W
LED250W

POL-0911
250x200 cm
LED380W



POL-0920
od 250 do 500 cm
LED 120 /180/250W



POL-0912
250x120 cm / 350x135 cm / 500x150 cm
LED115W / LED195W / LED260W



POL-0913
150x100 cm / 250x120 cm
350x135 cm / 500x150 cm
LED80W / LED115W
LED195W / LED260W



POL-0921
350x330 cm
LED380W

Thanks to their size, 3D figures are the most characteristic decorations in our catalogue. One cannot pass by them w/out a moment of reflection. These decorations are usually installed in the most prestigious places in Poland.

Figury 3D ze względu na swoje gabaryty są najbardziej charakterystycznymi ozdobami w naszym katalogu. Nie da się przejść obok nich bez chwili refleksji. Z reguły stoją one w najbardziej prestiżowych miejscach w Polsce.

AVAILABLE LED COLOURS / DOSTĘPNE KOLORY LED

cold white, neutral white, warm white, classic white, yellow, orange, pink, purple, red, blue, water blue, green, multicolor, RGB

biały zimny, biały neutralny, biały ciepły, biały klasyczny, żółty, pomarańczowy, różowy, fioletowy, czerwony, niebieski, niebieski morski, zielony, multikolor, RGB



POL-0958
200x300cm
LED225W

POL-0959
200x150cm
LED175W



POL-0932
300x420cm
LED250W



POL-0948
400x350 cm
LED400W

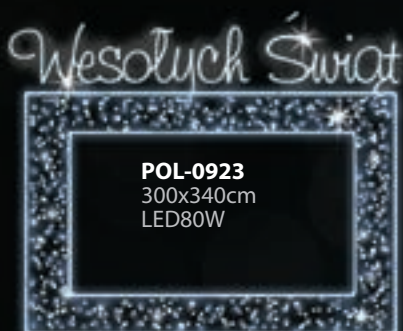

POL-0923
300x340cm
LED80W

POL-0957
200x300cm
LED210W



3D DECORATIONS / DEKORACJE 3D

REINDEERS, REINDEER TEAM WITH SANTA CLAUS / RENIFERY, ZAPRZĘGI Z MIKOŁAJEM



POL-0909
200x80x185 cm
LED45W



POL-1958
170x200 cm
LED180W



Reindeers and sleigh are separate decorations. We suggest coupling a reindeer w/ a sleigh - different variants are available on the following pages of the catalogue.

Renifery i sanie występują jako osobne dekoracje. Proponujemy połączenie renifera z saniami dostępnymi na następnych stronach katalogu.



POL-1938
120x80x185 cm
LED45W



POL-1939
140x80x185 cm
LED45W



POL-1940
200x80x185 cm
LED45W



POL-1974
200x800x185 cm
LED220W



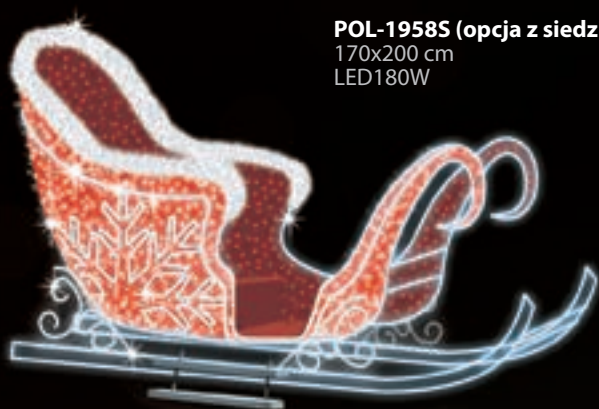

POL-1958S (opcja z siedziskiem)
 170x200 cm
 LED180W

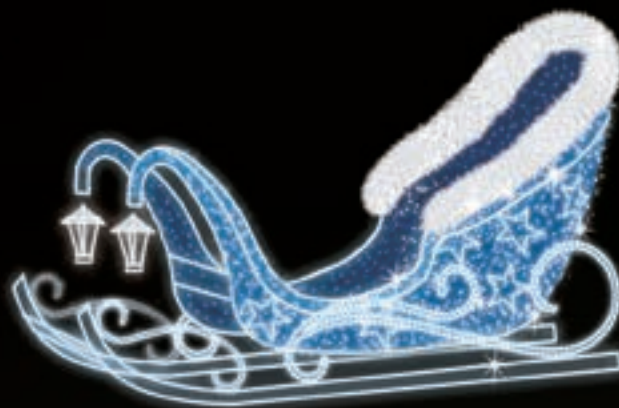

POL-1959
 170x200 cm
 LED230W

Such 3D figures as sleighs, carriages, vehicles, etc. can be fitted with seats and steps. We can fit other figures with seats on request.

Takie figury 3D jak sanie, karoce, pojazdy i inne posiadają opcję siedziska i odpowiednich schodków. Na życzenie istnieje możliwość zainstalowania siedziska także w innych figurach.

AVAILABLE LED COLOURS / DOSTĘPNE KOLORY LED

cold white, neutral white, warm white, classic white, yellow, orange, pink, purple, red, blue, water blue, green, multicolor, RGB

biały zimny, biały neutralny, biały ciepły, biały klasyczny, żółty, pomarańczowy, różowy, fioletowy, czerwony, niebieski, niebieski morski, zielony, multicolor, RGB



3D DECORATIONS / DEKORACJE 3D
SLEDGES / SANIE



POL-0910
100x200x80 cm
LED130W

POL-0993
170x140x70cm
LED98W



POL-1941
140x200x80 cm
LED150W

POL-1942
170x170x70 cm
LED120W



POL-1943
170x200x80 cm
LED160W



POL-1944
170x200x70 cm
LED115W

We suggest coupling a sleigh w/ figures available in our offer / Proponujemy połączenie sanie z figurami dostępnymi w naszej ofercie:



POL-1945
170x170x70 cm
LED115W





Sledges pulled by reindeers can be placed on the water thanks to special sponsons. Their buoyancy is adjusted to the weight of the whole installation so that the sponsons do not protrude from the water too much.

Zaprzęgi mogą być umieszczone na wodzie dzięki specjalnym pływakom. Wyporność pływaków jest tak dobierana by nie wystawały zbyt mocno z wody.

AVAILABLE LED COLOURS / DOSTĘPNE KOLORY LED

cold white, neutral white, warm white, classic white, yellow, orange, pink, purple, red, blue, water blue, green, multicolor, RGB

biały zimny, biały neutralny, biały ciepły, biały klasyczny, żółty, pomarańczowy, różowy, fioletowy, czerwony, niebieski, niebieski morski, zielony, multikolor, RGB



POL-2914
350x550 cm
LED1000W

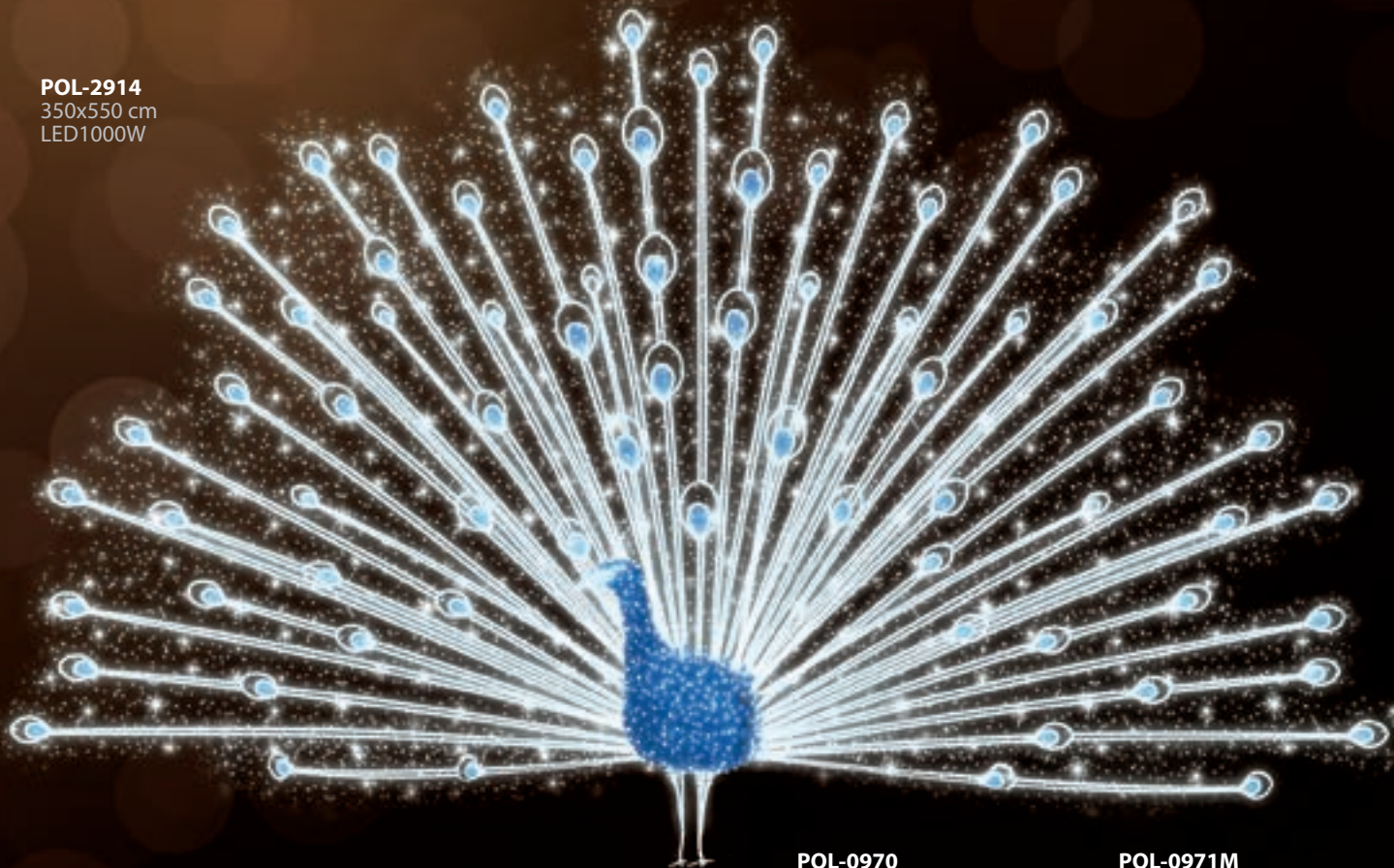

POL-0970
145x105x50 cm
LED39W

POL-0971M
145x105x50 cm
LED39W



POL-2915
200x130 cm
LED150W



POL-0968M
185x85 cm
LED45W

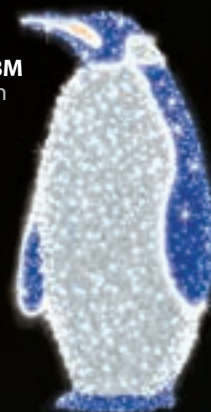

POL-1950
120x60 cm
LED45W



POL-1946M
110x210 cm
LED49W



POL-1946
110x210 cm
LED49W



POL-0999M
110x210 cm
LED49W



POL-0999
110x210 cm
LED49W



POL-0969
300x145x50 cm
LED60W



POL-1947
185x275x80 cm
LED85W



POL-1948
200x250cm
LED60W

AVAILABLE LED COLOURS / DOSTĘPNE KOLORY LED
cold white, neutral white, warm white, classic white, yellow, orange, pink, purple,
red, blue, water blue, green, multicolor, RGB

biały zimny, biały neutralny, biały ciepły, biały klasyczny, żółty, pomarańczowy, różowy,
fioletowy, czerwony, niebieski, niebieski morski, zielony, multikolor, RGB



3D DECORATIONS / DEKORACJE 3D

SANTAS / MIKOŁAJE



POL-0929M
225x180 cm
LED145W



POL-0972M
170x170 cm
LED138W



POL-0973M
170x200 cm
LED159W



POL-0975M
300x200 cm
LED285W



POL-2916
175x300 cm
LED320W



POL-0976M
200x180 cm
LED248W

AVAILABLE LED COLOURS / DOSTĘPNE KOLORY LED

cold white, neutral white, warm white, classic white, yellow, orange, pink, purple, red, blue, water blue, green, multicolor, RGB

biały zimny, biały neutralny, biały ciepły, biały klasyczny, żółty, pomarańczowy, różowy, fioletowy, czerwony, niebieski, niebieski morski, zielony, multikolor, RGB



POL-1001
200x350 cm
LED200W



POL-0801
200x250 cm
LED170W



3D DECORATIONS / DEKORACJE 3D
SANTAS / MIKOŁAJE



POL-2917
180x320 cm
LED650W



POL-2918
170x350 cm
LED825W

POL-0974M
300x200 cm
LED207W



POL-2919
400x500 cm
LED350W

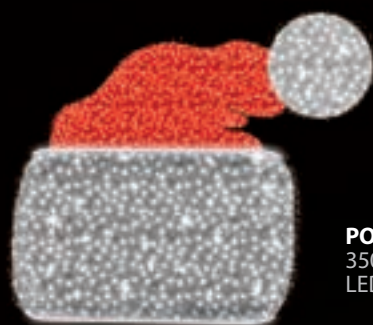

POL-2922
350x200 cm
LED330W

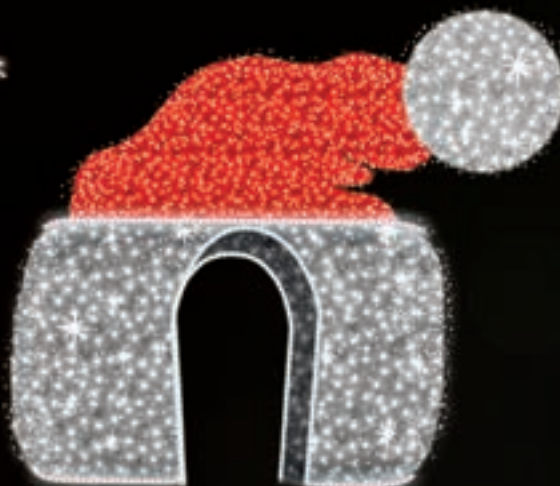



AVAILABLE LED COLOURS / DOSTĘPNE KOLORY LED

cold white, neutral white, warm white, classic white, yellow, orange, pink, purple, red, blue, water blue, green, multicolor, RGB

biały zimny, biały neutralny, biały ciepły, biały klasyczny, żółty, pomarańczowy, różowy, fioletowy, czerwony, niebieski, niebieski morski, zielony, multikolor, RGB



POL-2921
400x500 cm
LED400W



POL-2923
od 100 do 500 cm
LED60-400W

POL-2920
325x280 cm
LED325W

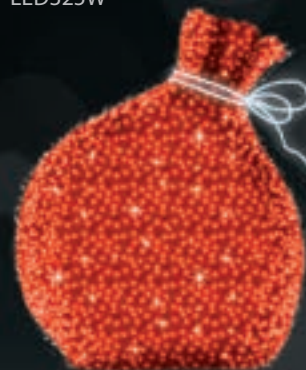

3D DECORATIONS / DEKORACJE 3D
SNOWMEN, IGLO / BAŁWANY, IGLO



POL-0977M/G
250x185 cm
LED140W



POL-0978M/G
250x160 cm
LED120W



POL-0930G
225x180 cm / 350x250 cm
LED145W / LED280W



POL-0907
200x180 cm
LED75W

POL-1949
200x180 cm
LED75W



POL-0922
200x200 cm
LED195W



POL-0979M
200x200 cm
LED195W





POL-1002G
 225x180 cm / 350x250 cm
 LED150W / LED300W

POL-1003G
 225x190 cm / 350x270 cm
 LED160W / LED320W



POL-1004G
 250x160 cm
 LED120W



AVAILABLE LED COLOURS / DOSTĘPNE KOLORY LED
 cold white, neutral white, warm white, classic white, yellow, orange, pink, purple,
 red, blue, water blue, green, multicolor, RGB

biały zimny, biały neutralny, biały ciepły, biały klasyczny, żółty, pomarańczowy, różowy,
 fioletowy, czerwony, niebieski, niebieski morski, zielony, multikolor, RGB



3D DECORATIONS / DEKORACJE 3D
TEDDY BEARS / MISIE



POL-0998M/G
380x270
LED575W

AVAILABLE LED COLOURS / DOSTĘPNE KOLORY LED
cold white, neutral white, warm white, classic white, yellow, orange, pink, purple, red, blue, water blue, green, multicolor, RGB

biały zimny, biały neutralny, biały ciepły, biały klasyczny, żółty, pomarańczowy, różowy, fioletowy, czerwony, niebieski, niebieski morski, zielony, multikolor, RGB



POL-0981M/G
260x260 cm
LED212W



POL-0949M/G
225x180 cm
LED138W



POL-0982M/G
240x180 cm
LED147W



POL-0983M/G
240x180 cm
LED168W



POL-0984M/G
250x220 cm
LED185W



POL-1998M/G
260x260 cm
LED150W



POL-1005
370x260 cm
LED300W



POL-0980M/G
300x260 cm
LED230W

AVAILABLE LED COLOURS / DOSTĘPNE KOLORY LED
cold white, neutral white, warm white, classic white, yellow, orange, pink, purple,
red, blue, water blue, green, multicolor, RGB

biały zimny, biały neutralny, biały ciepły, biały klasyczny, żółty, pomarańczowy, różowy,
fioletowy, czerwony, niebieski, niebieski morski, zielony, multikolor, RGB



3D DECORATIONS / DEKORACJE 3D

CARRIAGES, HORSE TEAMS / KAROCE, ZAPRZEGI

Such 3D figures as sleighs, carriages, vehicles, etc. can be fitted with seats and steps. We can fit other figures with seats on request.

Takie figury 3D jak sanie, karoce, pojazdy i inne posiadają opcję siedziska i odpowiednich schodków. Na życzenie istnieje możliwość zainstalowania siedziska także w innych figurach.



POL-0989
260x400 cm
LED305W



POL-0988
260x400 cm
LED365W



POL-0990
260x400 cm
LED330W



POL-0985
260x850x225 cm
LED485W



POL-0986
260x850x225 cm
LED425W

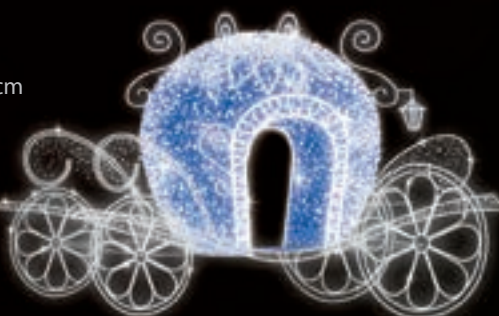

POL-0987
260x850x225 cm
LED450W



3D DECORATIONS / DEKORACJE 3D
CARRIAGES, HORSE TEAMS / KAROCE, ZAPRZEGI

AVAILABLE LED COLOURS / DOSTEPNE KOLORY LED

cold white, neutral white, warm white, classic white, yellow, orange, pink, purple,
 red, blue, water blue, green, multicolor, RGB

biały zimny, biały neutralny, biały ciepły, biały klasyczny, żółty, pomarańczowy, różowy,
 fioletowy, czerwony, niebieski, niebieski morski, zielony, multikolor, RGB



3D DECORATIONS / DEKORACJE 3D
 THRONES, SWING / TRONY, HUŚTAWKA

POL-0991
 200x100 cm
 LED94W



POL-0992
 220x100 cm
 LED118W



Ornate armchairs for children and adults. Thanks to their reinforced structure they are safe and can be sat on.

Bogato zdobione, duże fotele z możliwością siadania, dla dzieci i dorosłych. Dzięki wzmocnionej konstrukcji całkowicie bezpieczne.

POL-2924S
 320x220 cm
 LED150W



POL-1006
 100x100 cm
 LED60W

AVAILABLE LED COLOURS / DOSTĘPNE KOLORY LED
 cold white, neutral white, warm white, classic white, yellow, orange, pink, purple, red, blue, water blue, green, multicolor, RGB

biały zimny, biały neutralny, biały ciepły, biały klasyczny, żółty, pomarańczowy, różowy, fioletowy, czerwony, niebieski, niebieski morski, zielony, multikolor, RGB



Swing with seat.
 Huśtawka z siedziskiem.

POL-2925
Ø 400 cm
LED450W



POL-2926
Ø 400 cm
LED600W



3D DECORATIONS / DEKORACJE 3D

SAILING SHIP, SAILS / ŻAGLOWIEC, ŻAGLE

POL-2927
1000x1200 cm
LED5000W

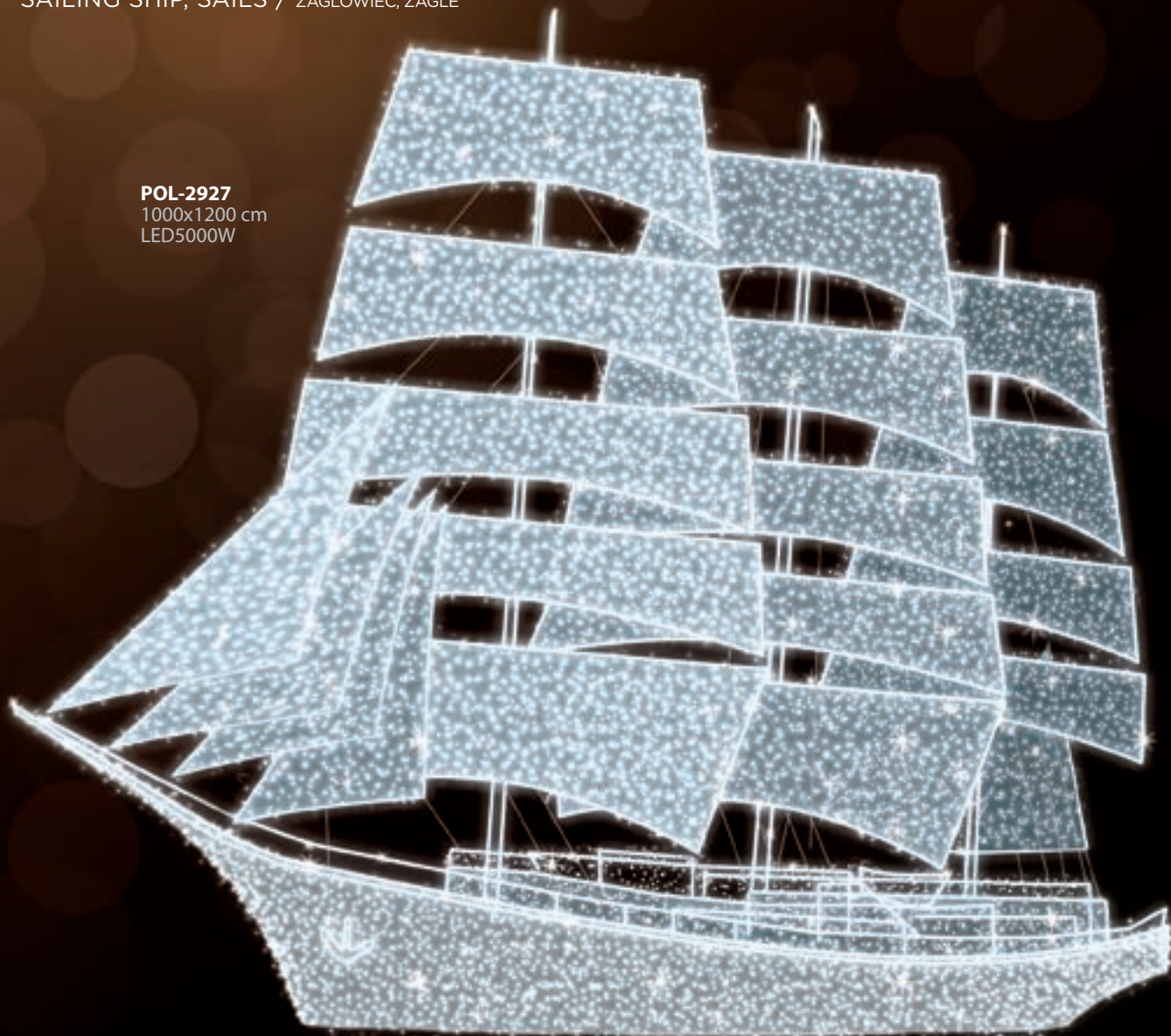

POL-0904
350x200 cm
LED288W



POL-2986
1200x450 cm
LED60W



POL-2986
600x500 cm
LED200W



AVAILABLE LED COLOURS / DOSTĘPNE KOLORY LED

cold white, neutral white, warm white, classic white, yellow, orange, pink, purple, red, blue, water blue, green, multicolor, RGB

biały zimny, biały neutralny, biały ciepły, biały klasyczny, żółty, pomarańczowy, różowy, fioletowy, czerwony, niebieski, niebieski morski, zielony, multikolor, RGB



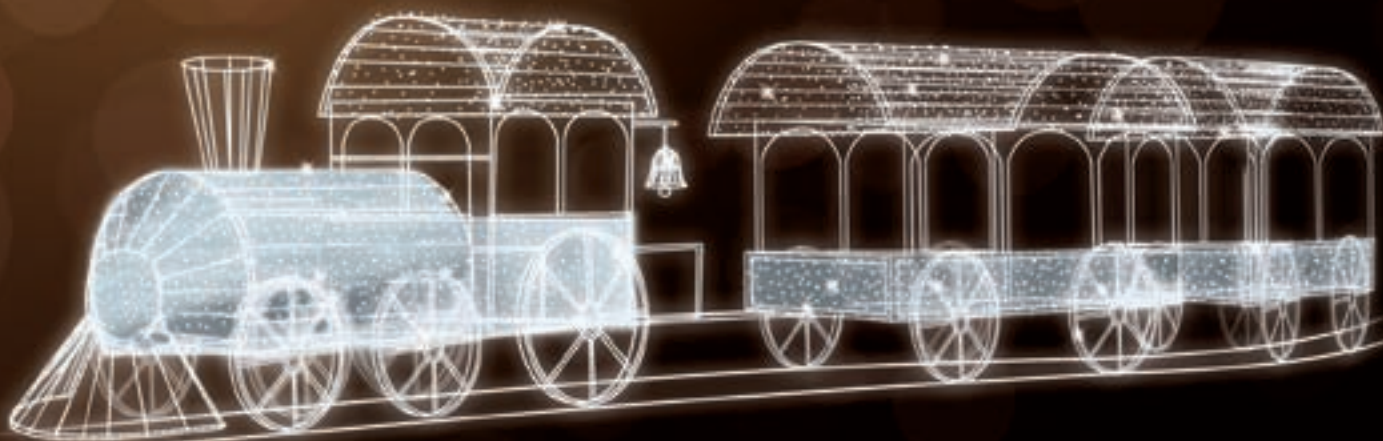

POL-2928

300x175x900 cm
LED1200W

Santa Claus' train - a set of 3D figures (Santa Claus, teddy bears, snowman, penguin, presents, trees) inside a train. The train is composed of LED lights and rope light and has a strong structure. One of the wagons can be entered into.

Pociąg mikołaja - zestaw figur 3D (mikołaj, misie, bałwan, pingwin, prezenty, drzewka) w pociągu. Pociąg wykonany z węża i lampek LED na trwałej, solidnej konstrukcji. Możliwość wejścia do jednego z wagonów.

POL-1652

330x 900x175cm
LED1750W



POL-2901

330x175x900 cm
LED1750W



POL-1007
210x310x1150 cm
LED2230W

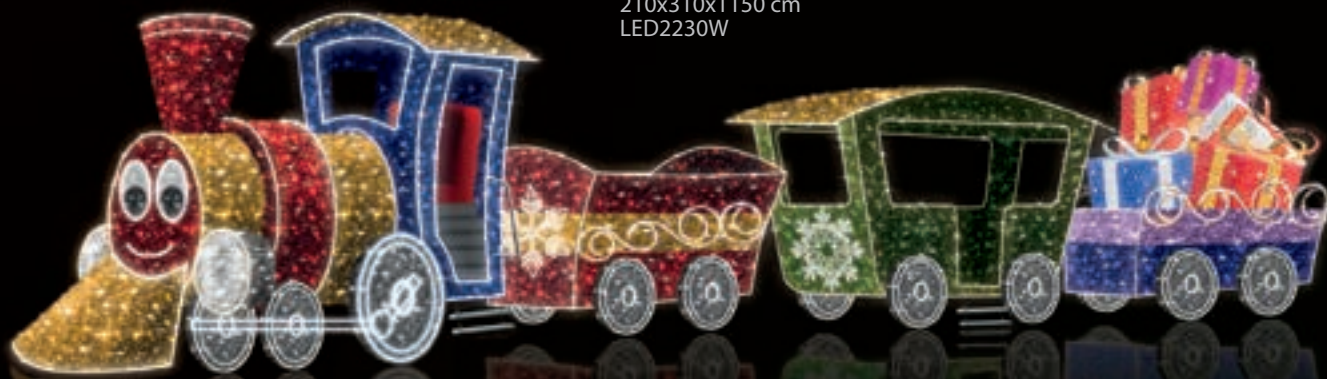

AVAILABLE LED COLOURS / DOSTĘPNE KOLORY LED

cold white, neutral white, warm white, classic white, yellow, orange, pink, purple, red, blue, water blue, green, multicolor, RGB

biały zimny, biały neutralny, biały ciepły, biały klasyczny, żółty, pomarańczowy, różowy, fioletowy, czerwony, niebieski, niebieski morski, zielony, multicolor, RGB



It is possible to get inside the vehicle.
Możliwość wejścia do środka pojazdu.



3D DECORATIONS / DEKORACJE 3D

CARS, BUS / SAMOCHODY, AUTOBUS

POL-1031

150x150x400 cm
LED1759W



POL-1032

150x150x400 cm
LED2100W



POL-2929

230x250x1000 cm
LED3500W



It is possible to get inside the vehicle.
Możliwość wejścia do środka pojazdu.

POL-1008
280x160x550 cm
LED3500W



It is possible to get inside the vehicle.
Możliwość wejścia do środka pojazdu.

POL-1035
200x200x600 cm
LED3500W



It is possible to get inside the vehicle.
Możliwość wejścia do środka pojazdu.

AVAILABLE LED COLOURS / DOSTĘPNE KOLORY LED

cold white, neutral white, warm white, classic white, yellow, orange, pink, purple, red, blue, water blue, green, multicolor, RGB

biały zimny, biały neutralny, biały ciepły, biały klasyczny, żółty, pomarańczowy, różowy, fioletowy, czerwony, niebieski, niebieski morski, zielony, multikolor, RGB



3D DECORATIONS / DEKORACJE 3D

AIRPLANE, TANKS / SAMOLOT, CZOŁGI

Airplane with/without Santa Claus
Samolot z mikołajem Sam samolot

POL-2934MI
250x800 cm
LED1200W

POL-2934
250x800 cm
LED1100W



POL-2930PR
380x370x970 cm
LED3200W

POL-2930MI
380x370x970 cm
LED3050W



POL-2930
300x370x970 cm
LED2950W

POL-2931MI
280x370x1000 cm
LED3000W



POL-2931
250x370x1000 cm
LED2900W



Santa Claus, presents, or any other 3D elements can be added to tanks. **MI - Santa Claus, PR - presents.**

Czołgi mogą być uzupełnione figurą mikołaja lub prezentami lub dowolnym innym elementem przestrzennym. **MI - mikołaj, PR - prezenty.**

3D DECORATIONS / DEKORACJE 3D
AIRPLANE, TANKS / SAMOLOT, CZOŁGI



AVAILABLE LED COLOURS / DOSTĘPNE KOLORY LED

cold white, neutral white, warm white, classic white, yellow, orange, pink, purple, red, blue, water blue, green, multicolor, RGB

biały zimny, biały neutralny, biały ciepły, biały klasyczny, żółty, pomarańczowy, różowy, fioletowy, czerwony, niebieski, niebieski morski, zielony, multikolor, RGB



3D DECORATIONS / DEKORACJE 3D

BALOONS / BALONY

AVAILABLE LED COLOURS DOSTĘPNE KOLORY LED

cold white, neutral white, warm white,
classic white, yellow, orange, pink, purple,
red, blue, water blue, green, multicolor, RGB

biały zimny, biały neutralny, biały ciepły,
biały klasyczny, żółty, pomarańczowy,
różowy, fioletowy, czerwony, niebieski,
niebieski morski, zielony, multikolor, RGB



Santa Claus, presents, or any other 3D elements can be added to balloons. **MI - Santa Claus, PR - presents.**

Balony mogą być uzupełnione figurą mikołaja lub prezentami lub dowolnym innym elementem przestrzennym. **MI - mikołaj, PR - prezenty.**



POL-1009
600x350cm
LED 1900

POL-1009MI
600x350cm
LED2000W

POL-1009PR
600x350cm
LED2100

It is possible to get inside the basket.
Opcjonalnie istnieje możliwość wejścia do kosza balonu.



POL-2932
600x350 cm
LED 1900

POL-2932MI
600x350 cm
LED2000W

POL-2932PR
600x350 cm
LED2100W



POL-2933
600x350cm
LED 1900

POL-2933MI
600x350cm
LED2000W

POL-2933PR
600x350cm
LED2100

3D DECORATIONS / DEKORACJE 3D

BALOONS / BALONY

AVAILABLE LED COLOURS / DOSTĘPNE KOLORY LED

cold white, neutral white, warm white, classic white, yellow, orange, pink, purple, red, blue, water blue, green, multicolor, RGB

biały zimny, biały neutralny, biały ciepły, biały klasyczny, żółty, pomarańczowy, różowy, fioletowy, czerwony, niebieski, niebieski morski, zielony, multikolor, RGB



3D DECORATIONS / DEKORACJE 3D
WATERMILL, MERRY GO ROUND / MŁYN WODNY, KARUZELA

POL-2935
600x500x700 cm
LED4750W



POL-2936
500x650 cm
LED3000W



AVAILABLE LED COLOURS / DOSTĘPNE KOLORY LED

cold white, neutral white, warm white, classic white, yellow, orange, pink, purple, red, blue, water blue, green, multicolor, RGB

biały zimny, biały neutralny, biały ciepły, biały klasyczny, żółty, pomarańczowy, różowy, fioletowy, czerwony, niebieski, niebieski morski, zielony, multicolor, RGB



3D DECORATIONS / DEKORACJE 3D
COLUMNS, COPING / KOLUMNY, KOLUMNY ZE SKLEPIENIEM



POL-2937
600x210 cm
LED350W



POL-2938
600x210 cm
LED350W



POL-2939
600x210 cm
LED350W



POL-2940
600x450 cm
LED450W



POL-2942
150x90 cm
LED65W

POL-2941
150x80 cm
LED65W



AVAILABLE LED COLOURS / DOSTĘPNE KOLORY LED

cold white, neutral white, warm white, classic white, yellow, orange, pink, purple,
red, blue, water blue, green, multicolor, RGB

biały zimny, biały neutralny, biały ciepły, biały klasyczny, żółty, pomarańczowy, różowy,
fioletowy, czerwony, niebieski, niebieski morski, zielony, multikolor, RGB



3D DECORATIONS / DEKORACJE 3D
EAGLES, LANCER, FLAGS / UŁAN, ORZEŁ, FLAGI



POL-2943
350x250 cm
LED650W



POL-2944
400x300 cm
LED585W



POL-2945
250x220 cm
LED225W

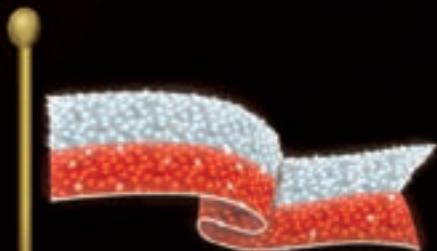

POL-2946
200x600 cm
LED85W



POL-2947
wysokość:
od 200 do 500 cm
LED285W

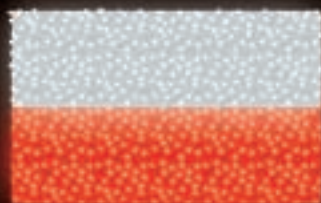

POL-2948
wysokość:
od 200 do 500 cm
LED50-350W



POL-2981
175x120 cm
LED150W

3D DECORATIONS / DEKORACJE 3D
EAGLES, FLAGS / ORZEŁ, FLAGI

POL-2949
 250x250 cm
 LED275W



POL-2950
 250x600 cm
 LED450W



POL-2951
 300x320 cm
 LED300W



POL-2952
 250x250 cm
 LED275W

11.11.2018

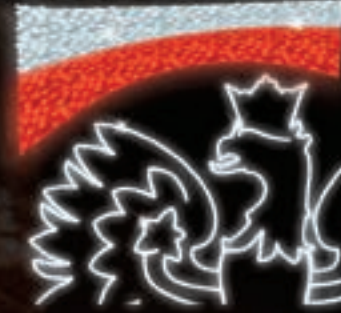

POL-2953
 250x200 cm
 LED200W

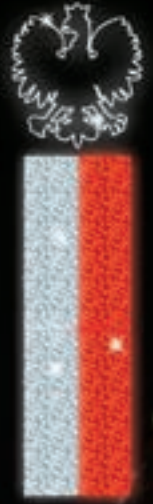

POL-2954
 400x150 cm
 LED180W



AVAILABLE LED COLOURS / DOSTĘPNE KOLORY LED
 cold white, neutral white, warm white, classic white, yellow, orange, pink, purple,
 red, blue, water blue, green, multicolor, RGB
 biały zimny, biały neutralny, biały ciepły, biały klasyczny, żółty, pomarańczowy, różowy,
 fioletowy, czerwony, niebieski, niebieski morski, zielony, multikolor, RGB





POL-1650
350x500 cm
LED675W



Polar island - a set of 3D figures (bears, penguins) on a polar island. The island is composed of a white LED mat surrounded by water which is imitated by a blue mat and white or blue LED lights.

Polarna wyspa - zestaw figur 3D (niedźwiedzie, pingwiny) na polarnej wyspie. Wyspa z białej maty pokrytej lampkami LED otoczona wodą z niebieskiej maty i białych lub niebieskich lampek LED.

Santa Claus' ice island - a set of 3D figures (Santa Claus, teddy bear, snowman, penguin, presents, cones) on an ice island. The island is composed of a white LED mat surrounded by water which is imitated by a blue mat and white or blue LED lights.

Lodowa wyspa mikołaja - zestaw figur 3D (mikołaj, miś, bałwan, pingwin, prezenty, stożki) na lodowej wyspie. Wyspa z białej maty pokrytej lampkami LED otoczona wodą z niebieskiej maty i białych lub niebieskich lampek LED.

POL-1651
750x800 cm
LED2250W



3D DECORATIONS / DEKORACJE 3D
CHRISTMAS MUSIC BAND, SANTA CLAUS' ARMCHAIR
 ŚWIĄTECZNY ZESPÓŁ MUZYCZNY, FOTEL MIKOŁAJA



POL-1010
 350x400 cm
 LED635W

Santa Claus' armchair - a set of 3D figures (Santa Claus, armchair, presents) and three-metre high Christmas trees. Children and adults can sit on the armchair (to pose for a picture).

Fotel mikołajka - zestaw figur 3D (mikołaj, fotel, prezenty) i choinek 3m. Możliwość siadania na fotelu (do zdjęcia) dla dzieci i dorosłych.



POL-1653
 225x350 cm
 LED445W

3D DECORATIONS / DEKORACJE 3D

CHRISTMAS CRIBS / SZOPKA

POL-1951
250x400 cm
LED590W



POL-1952
180x225cm
LED280W



POL-1953
180x225cm
LED210W

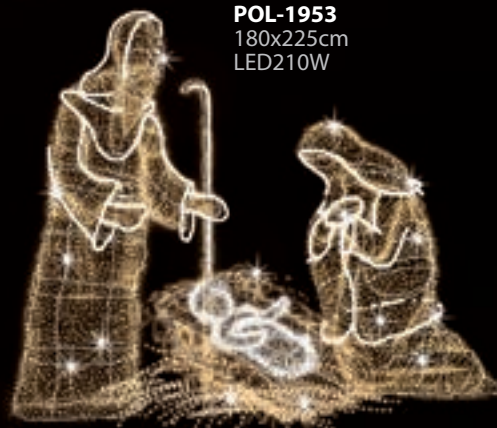

100x100-60W 150x70-70W 180x80-80W 180x80-80W 150x80-70W 150x80-70W 80x80-60W 250x400-100W

* wymiary w cm

POL-1011
250x400 cm
LED400W



AVAILABLE LED COLOURS / DOSTĘPNE KOLORY LED

cold white, neutral white, warm white, classic white, yellow, orange, pink, purple, red, blue, water blue, green, multicolor, RGB

biały zimny, biały neutralny, biały ciepły, biały klasyczny, żółty, pomarańczowy, różowy, fioletowy, czerwony, niebieski, niebieski morski, zielony, multicolor, RGB



POL-1951M
250x400 cm
LED590W

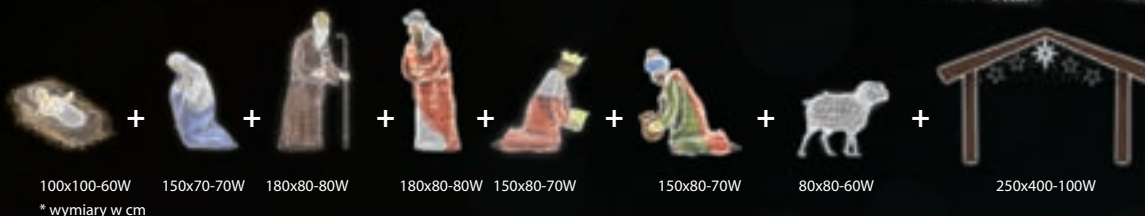

POL-1952M
180x225cm
LED280W



POL-1953M
180x225cm
LED210W



I ♥ KRYNICA MORSKA

POL-2955
250x1500 cm
LED1200W

POL-2956
350x450 cm
LED850W

I ♥
MRAĞOWO

I ♥ elk

POL-2957
300x750 cm
LED695W

POL-2958
300x1500 cm
LED825W

I ♥ MRAĞOWO

POL-1012
200x1500 cm
LED700W

PRUSZK ♥ W



POL-1013
300x1500 cm
LED850W



POL-1014
450x700 cm
LED620W

AVAILABLE LED COLOURS / DOSTĘPNE KOLORY LED

cold white, neutral white, warm white, classic white, yellow, orange, pink, purple, red, blue, water blue, green, multicolor, RGB

biały zimny, biały neutralny, biały ciepły, biały klasyczny, żółty, pomarańczowy, różowy, fioletowy, czerwony, niebieski, niebieski morski, zielony, multikolor, RGB



POL-2959
500x1100 cm
LED1100W



3D DECORATIONS / DEKORACJE 3D

LETTERINGS / NAPISY „I LOVE...”, INNE

AVAILABLE LED COLOURS / DOSTĘPNE KOLORY LED
cold white, neutral white, warm white, classic white, yellow, orange, pink, purple,
red, blue, water blue, green, multicolor, RGB

biały zimny, biały neutralny, biały ciepły, biały klasyczny, żółty, pomarańczowy, różowy,
fioletowy, czerwony, niebieski, niebieski morski, zielony, multikolor, RGB



I ♥ GM

POL-1033
300x750 cm
LED695W

WŁOCŁAWEK



POL-1015
200x2000 cm
LED1100W

Włocławek



POL-1016
200x2000 cm
LED1125W

Włocławek





POL-0951
250x650 cm
LED295W



POL-0952
250x650 cm
LED320W

POL-0953
250x650 cm
LED395W



AVAILABLE LED COLOURS / DOSTĘPNE KOLORY LED

cold white, neutral white, warm white, classic white, yellow, orange, pink, purple,
red, blue, water blue, green, multicolor, RGB

biały zimny, biały neutralny, biały ciepły, biały klasyczny, żółty, pomarańczowy, różowy,
fioletowy, czerwony, niebieski, niebieski morski, zielony, multikolor, RGB



3D DECORATIONS / DEKORACJE 3D
PASSAGES, TUNNELS, GATES / PRZEJŚCIA, TUNELE

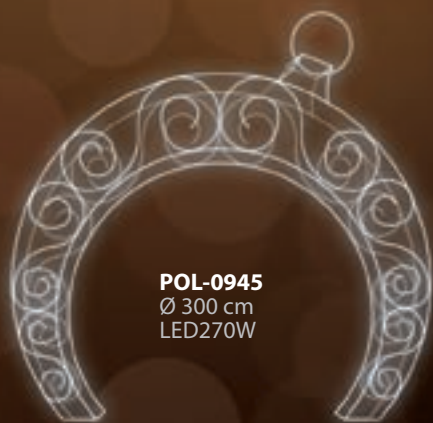

POL-0945
Ø 300 cm
LED270W



POL-0946
Ø 300 cm
LED295W



POL-2960
400x450x50 cm
LED385W



POL-2961
450x350x100 cm
LED300W



POL-2962
450x350x100 cm
LED300W



POL-2963
450x350x100 cm
LED300W

POL-0947
Ø 300 cm
LED315W





POL-2964
 400x600x100 cm
 LED750W

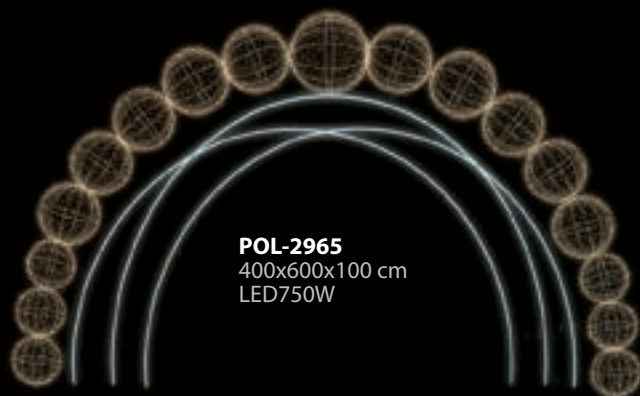

POL-2965
 400x600x100 cm
 LED750W



POL-2966
 400x600x100 cm
 LED750W



POL-2967
 400x600x100 cm
 LED750W



AVAILABLE LED COLOURS / DOSTĘPNE KOLORY LED
 cold white, neutral white, warm white, classic white, yellow, orange, pink, purple,
 red, blue, water blue, green, multicolor, RGB
 biały zimny, biały neutralny, biały ciepły, biały klasyczny, żółty, pomarańczowy, różowy,
 fioletowy, czerwony, niebieski, niebieski morski, zielony, multicolor, RGB



STREET DECORATIONS / DEKORACJE ULICZNE
PASSAGES, TUNNELS, GATES / PRZEJŚCIA, TUNELE



POL-2968
400x600 cm
LED250W



POL-2969
400x600x50 cm
LED585W

AVAILABLE LED COLOURS / DOSTĘPNE KOLORY LED
cold white, neutral white, warm white, classic white, yellow, orange, pink, purple,
red, blue, water blue, green, multicolor, RGB

biały zimny, biały neutralny, biały ciepły, biały klasyczny, żółty, pomarańczowy, różowy,
fioletowy, czerwony, niebieski, niebieski morski, zielony, multikolor, RGB





POL-1350
500x600 cm
LED580W



POL-1351
500x600 cm
LED525W



STREET DECORATIONS / DEKORACJE ULICZNE

PASSAGES, TUNNELS, GATES / PRZEJŚCIA, TUNELE



LED curtain firmaments can be decorated w/ any plane figures formed from LED rope lights. We offer the following variants:

Sklepienia z kurtyn LED mogą być ozdobione dowolnymi figurami płaskimi z węża LED. Poniżej nasze propozycje:

POL-1380

160x200x300 cm
LED 150W

POL-1381

160x200x300 cm
LED 150W

POL-1382

160x200x300 cm
LED 150W

POL-1383

160x200x300 cm
LED 175W





POL-1370M
210x500x100 cm
LED275W

High arches composed of LED rope lights and lights. They can be set in the form of single passages or long, illuminated tunnels. They are perfect whether it is a park or the old town.

Wysokie łuki z węża LED i lampek. Ustawione nad chodnikami mogą tworzyć pojedyncze przejścia lub długie rozświetlone tunele. Sprawdzają się doskonale na obszarach staromiejPOL-1370M skich i w parkach.

AVAILABLE LED COLOURS / DOSTĘPNE KOLORY LED

cold white, neutral white, warm white, classic white, yellow, orange, pink, purple, red, blue, water blue, green, multicolor, RGB

biały zimny, biały neutralny, biały ciepły, biały klasyczny, żółty, pomarańczowy, różowy, fioletowy, czerwony, niebieski, niebieski morski, zielony, multikolor, RGB





POL-1371
260x500x100 cm
LED250W



AVAILABLE LED COLOURS / DOSTĘPNE KOLORY LED

cold white, neutral white, warm white, classic white, yellow, orange, pink, purple, red, blue, water blue, green, multicolor, RGB

biały zimny, biały neutralny, biały ciepły, biały klasyczny, żółty, pomarańczowy, różowy, fioletowy, czerwony, niebieski, niebieski morski, zielony, multikolor, RGB





Modular tunnels composed of any number of sections (passages), decorated w/ LED rope lights shaped into stars. The tunnels also have suspended PVC baubles which are available in five different colours.

Tunele modułowe składające się z dowolnej ilości łuków (przejść), ozdobione gwiazdami z węża LED. Dodatkowo posiadają podwieszane bombki PCV w jednym z pięciu dostępnych kolorów.

POL-1372
260x500x100 cm
LED250W



POL-2982
700x475 cm
LED1750W



POL-2983
700x475 cm
LED1750W



POL-2984
700x475 cm
LED1750W



POL-2985
600x475 cm
LED1750W



AVAILABLE LED COLOURS / DOSTĘPNE KOLORY LED

cold white, neutral white, warm white, classic white, yellow, orange, pink, purple, red, blue, water blue, green, multicolor, RGB

biały zimny, biały neutralny, biały ciepły, biały klasyczny, żółty, pomarańczowy, różowy, fioletowy, czerwony, niebieski, niebieski morski, zielony, multikolor, RGB



POL-1986
400x300 cm
LED984W

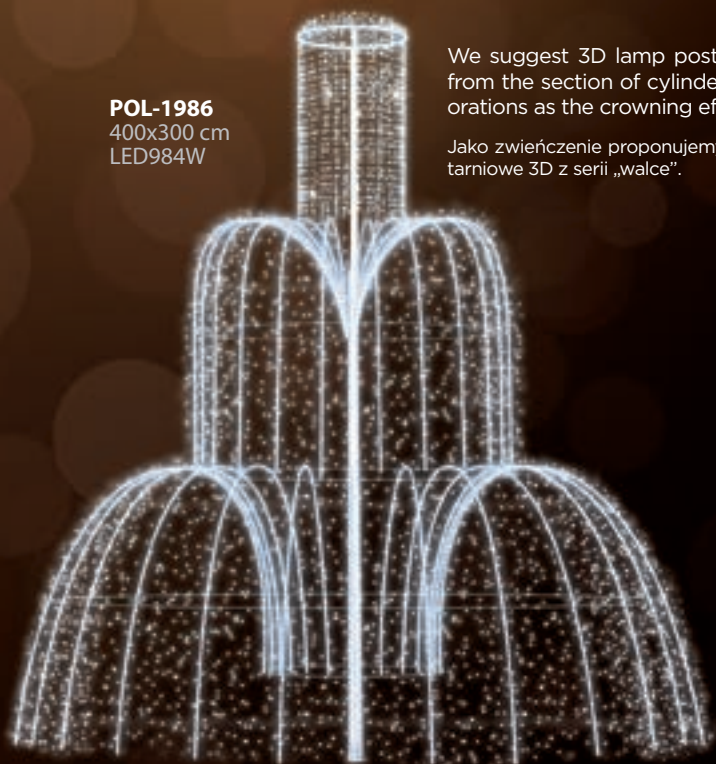

We suggest 3D lamp post decorations from the section of cylinder shape decorations as the crowning effect.

Jako zwieńczenie proponujemy dekoracje latarniowe 3D z serii „walce”.

POL-1987
400x300 cm
LED650W

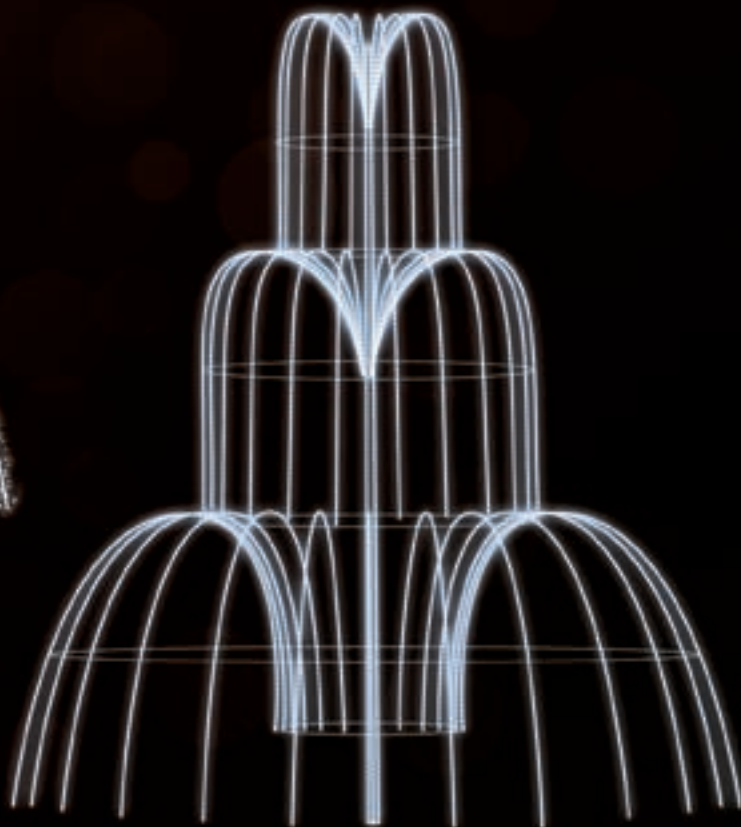

POL-1988
450x350 cm/650x475 cm
LED1085W/LED1750W



POL-1989
300x275 cm
LED650W



AVAILABLE LED COLOURS / DOSTĘPNE KOLORY LED

cold white, neutral white, warm white, classic white, yellow, orange, pink, purple,
red, blue, water blue, green, multicolor, RGB

biały zimny, biały neutralny, biały ciepły, biały klasyczny, żółty, pomarańczowy, różowy,
fioletowy, czerwony, niebieski, niebieski morski, zielony, multikolor, RGB



POL-1981
400x300 cm
LED740W

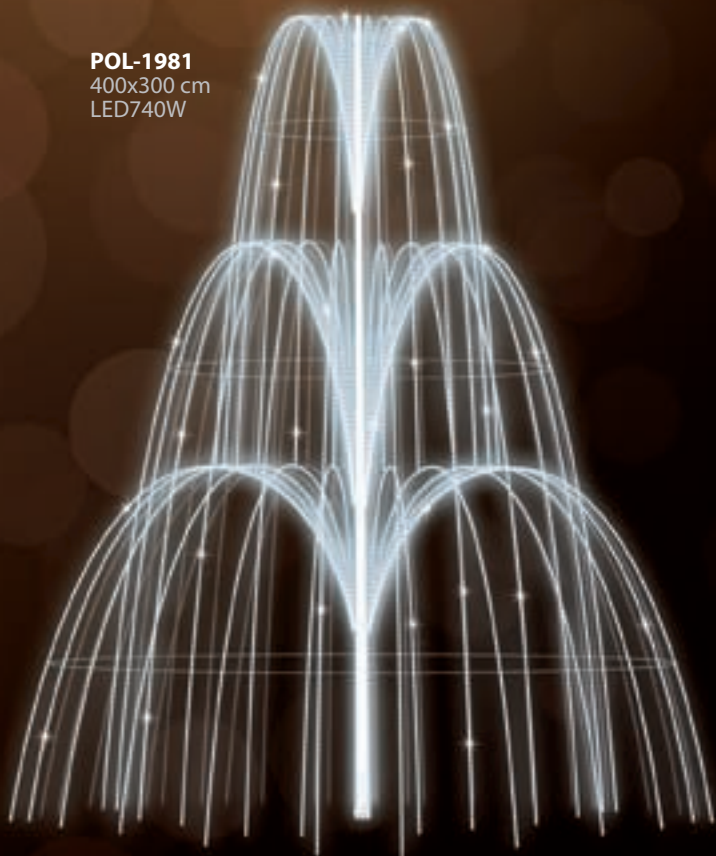

POL-1982
400x300 cm
LED650W



The fountains can be composed either of LED lights or LED rope lights only. They can also be composed of both. In addition, they can be embellished w/ PVC baubles. These strong structures are based on aluminium elements joined w/ the use of the TIG welding technology.

Fontanny mogą być zbudowane z samych lampek LED, z samych węży LED lub łączyć w sobie obydwie źródła światła. Dodatkowo mogą być udekorowane bombkami PCV. Oczywiście w każdym przypadku zbudowane są na mocnej konstrukcji aluminiowej spawanej technologią TIG.

We suggest 3D lamp post decorations from the section of goblets as the crowning effect.

Jako zwieńczenie proponujemy dekoracje latarniowe 3D z serii „kielichy”.

POL-1983
400x400 cm
LED625W



POL-1984
400x400 cm
LED880W

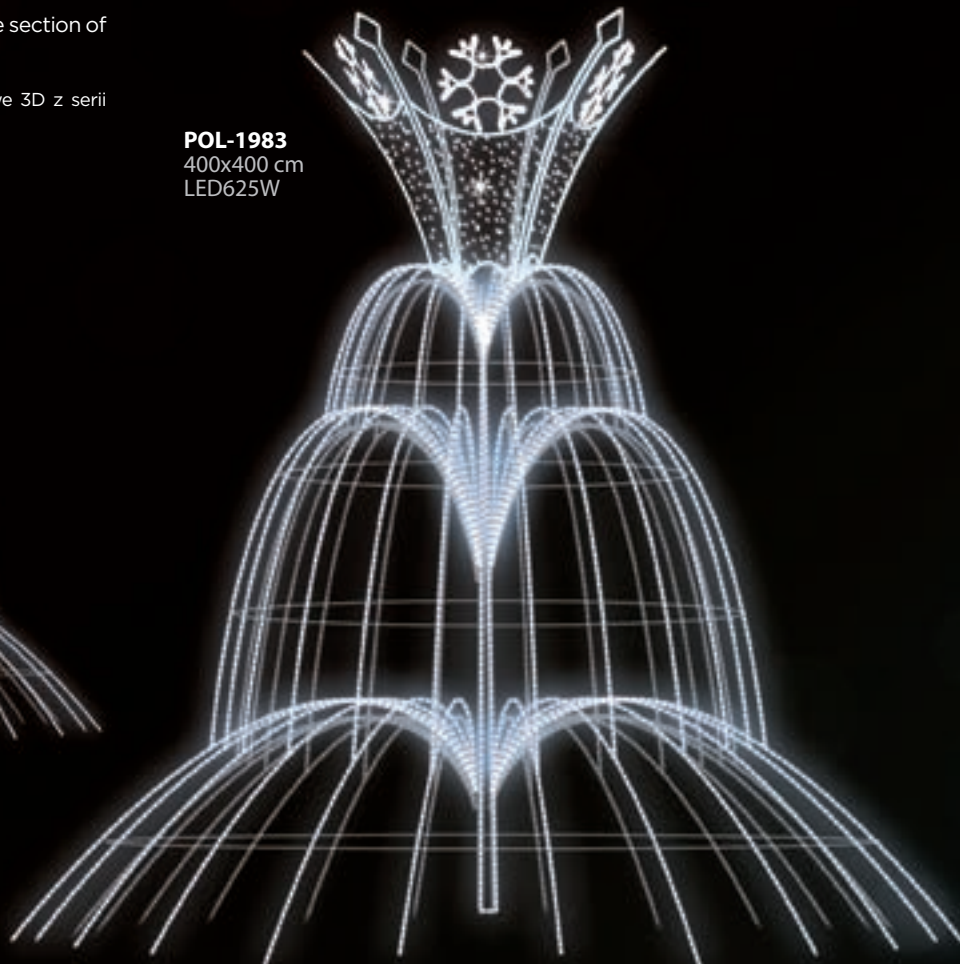

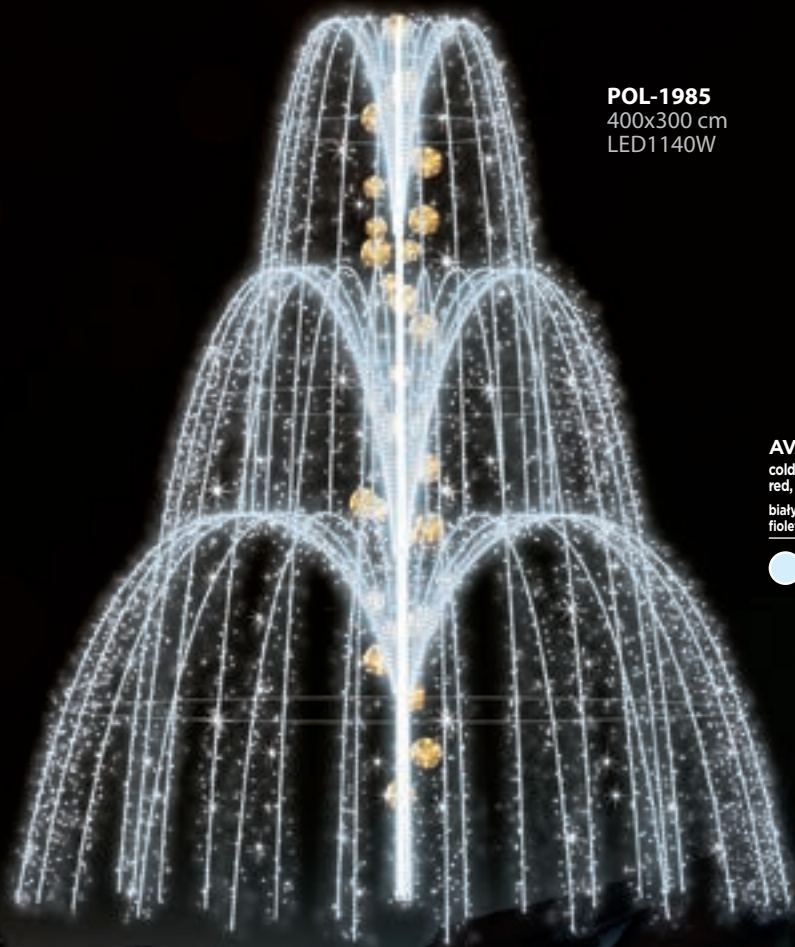

POL-1985
400x300 cm
LED1140W

An example of a fountain w/ PVC baubles which are available in five different colours.

Przykład użycia w fontannie bombek PCV w jednym z pięciu dostępnych kolorów.



AVAILABLE LED COLOURS / DOSTĘPNE KOLORY LED

cold white, neutral white, warm white, classic white, yellow, orange, pink, purple, red, blue, water blue, green, multicolor, RGB

biały zimny, biały neutralny, biały ciepły, biały klasyczny, żółty, pomarańczowy, różowy, fioletowy, czerwony, niebieski, niebieski morski, zielony, multikolor, RGB



3D DECORATIONS / DEKORACJE 3D

FOUNTAINS / FONTANNY

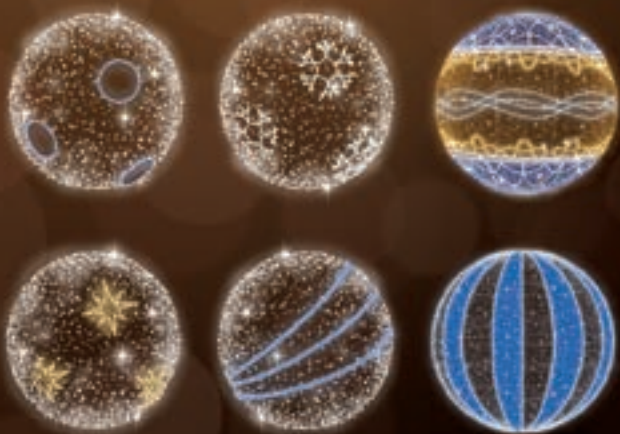

An amazing effect of a hanging sphere is the crowning element of a fountain. Decorative spheres are available in the section of 3D spheres.

Jako zwieńczenie fontanny niesamowity efekt wiszącej kuli. Do wyboru dekoracje z sekcji Kule 3D.

POL-0931
250x300 cm
LED375W



POL-2970
250x250 cm
LED350W

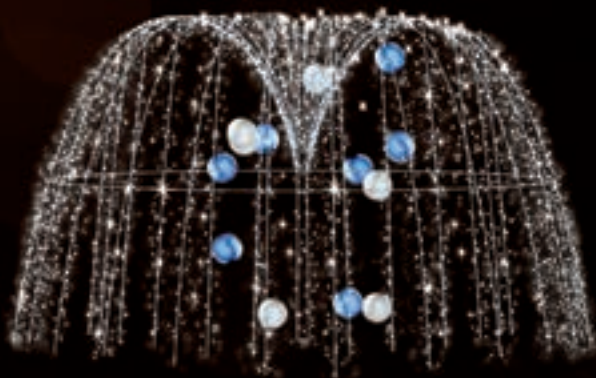

Fountains are becoming increasingly popular year by year. They embellish ordinary fountains, plazas, squares, etc.

Fontanny z roku na rok uzyskują coraz większą popularność. Dzięki nim zagospodarowywane są smutne, ponure i tradycyjne fontanny, skwerki, place itp.

POL-2971
300x300 cm
LED325W



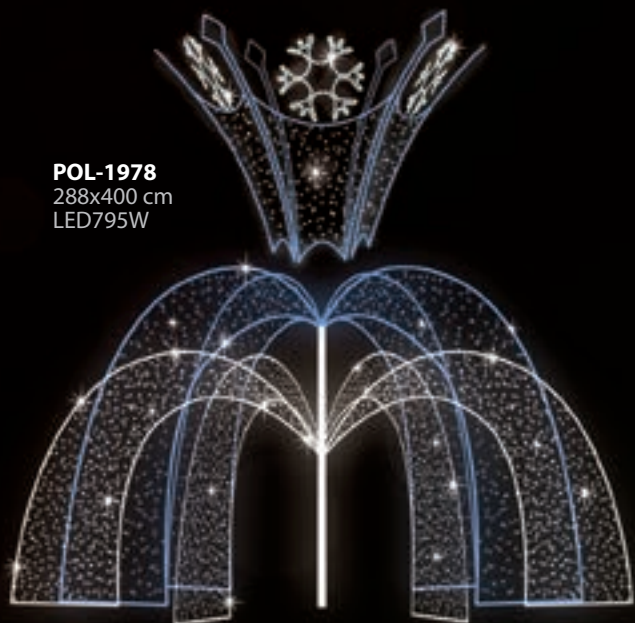

POL-1978
288x400 cm
LED795W



We suggest a 3D lamp post decoration from the section of goblets as the crowning effect.

Jako zwieńczenie proponujemy dekorację latarniową 3D z serii „kielichy”.

AVAILABLE LED COLOURS / DOSTĘPNE KOLORY LED

cold white, neutral white, warm white, classic white, yellow, orange, pink, purple, red, blue, water blue, green, multicolor, RGB

biały zimny, biały neutralny, biały ciepły, biały klasyczny, żółty, pomarańczowy, różowy, fioletowy, czerwony, niebieski, niebieski morski, zielony, multicolor, RGB



POL-1960
250x400 cm
LED520W



POL-2972
400x350 cm
LED285W



POL-2973
500x500 cm
LED480W



POL-2974
400x350 cm
LED330W

3D DECORATIONS / DEKORACJE 3D

FOUNTAINS / FONTANNY

POL-1017
400x350 cm
LED940W



POL-1018
365x65x130 cm
LED375W

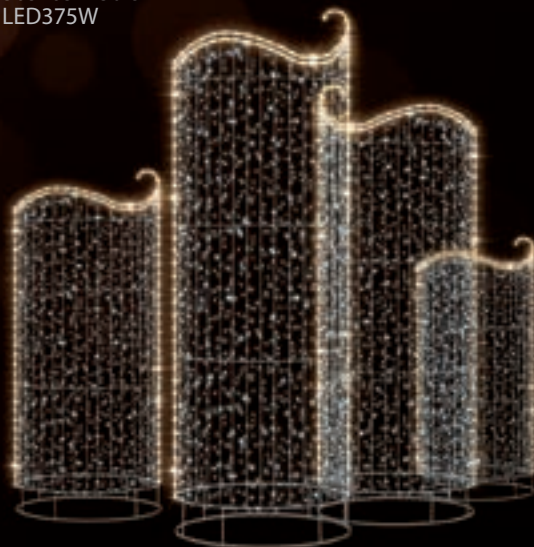

POL-1977
400x350 cm
LED475W

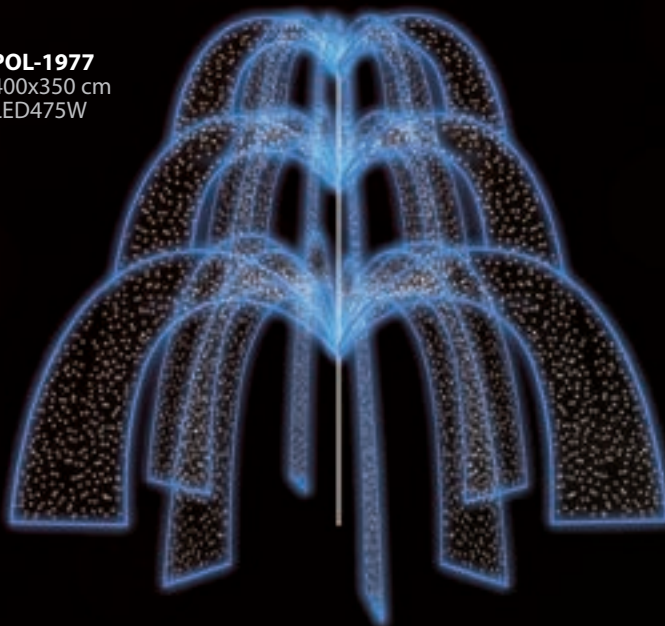

In the case of meteor shower rain lights we can observe the falling light effect. It can be the falling water effect in the case of fountain.

W przypadku meteorków możemy zaobserwować tzw. „efekt spadającego światła”. W przypadku fontanny może to być efekt spadającej wody.

POL-0933
250x300 cm
LED310W



POL-0906
250x300 cm
LED320W



POL-1979
300x300 cm
LED350W

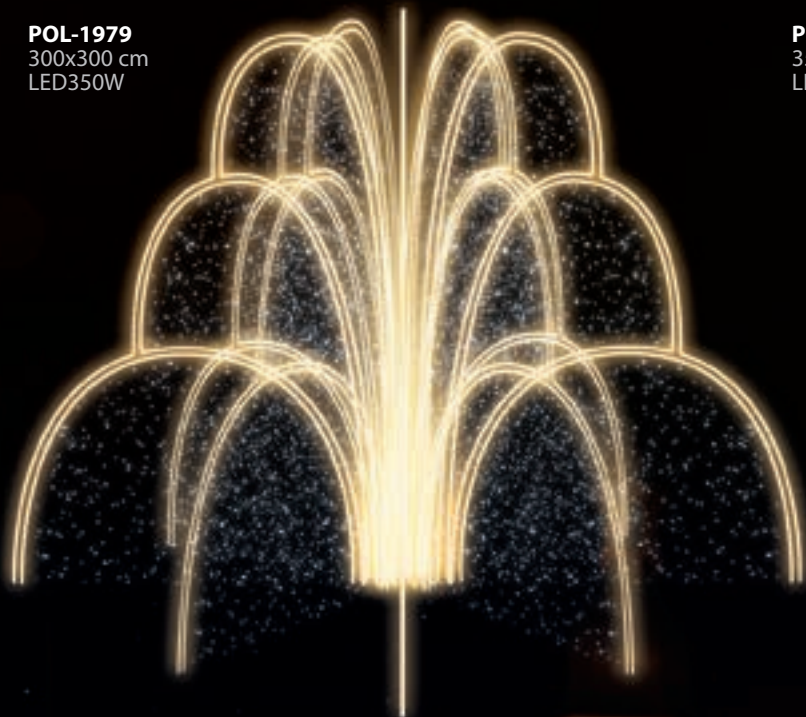

POL-1961
350x400 cm
LED725W

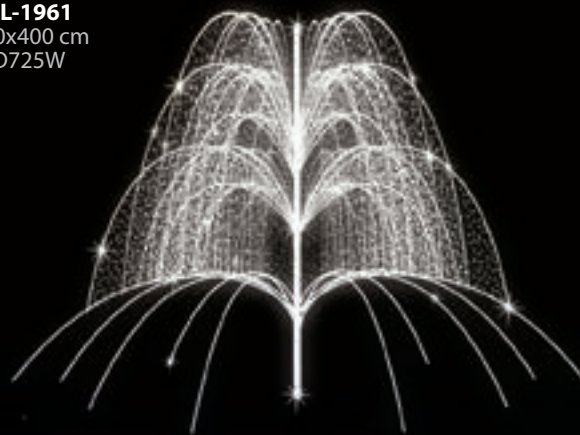

AVAILABLE LED COLOURS / DOSTĘPNE KOLORY LED

cold white, neutral white, warm white, classic white, yellow, orange, pink, purple, red, blue, water blue, green, multicolor, RGB

biały zimny, biały neutralny, biały ciepły, biały klasyczny, żółty, pomarańczowy, różowy, fioletowy, czerwony, niebieski, niebieski morski, zielony, multikolor, RGB



3D DECORATIONS / DEKORACJE 3D

FOUNTAINS / FONTANNY

POL-2975
600x600 cm
LED750W



POL-2976
600x600 cm
LED650W



AVAILABLE LED COLOURS / DOSTĘPNE KOLORY LED

cold white, neutral white, warm white, classic white, yellow, orange, pink, purple, red, blue, water blue, green, multicolor, RGB

biały zimny, biały neutralny, biały ciepły, biały klasyczny, żółty, pomarańczowy, różowy, fioletowy, czerwony, niebieski, niebieski morski, zielony, multikolor, RGB





POL-1962
 300x250 cm / 400x300 cm
 LED525W / LED768W



POL-0903
 290x170 / 475x270 / 800x450 cm
 LED281W / LED772W / LED1280W



POL-0901
 300x350 cm
 LED338W



POL-0905
 300x250 cm
 LED385W



POL-0902
 200x320 cm / 400x650 cm / 600x950 cm
 LED302W / LED535W / LED1094W





POL-1963
300x120 cm, LED200W



POL-1964
200x120 cm, LED150W



POL-1965
200x120 cm, LED100W





AVAILABLE LED COLOURS / DOSTĘPNE KOLORY LED

cold white, neutral white, warm white, classic white, yellow, orange, pink, purple, red, blue, water blue, green, multicolor, RGB

biały zimny, biały neutralny, biały ciepły, biały klasyczny, żółty, pomarańczowy, różowy, fioletowy, czerwony, niebieski, niebieski morski, zielony, multikolor, RGB



POL-1019
300x200 cm
LED415W



POL-1966
300x200 cm
LED415W



POL-2977
150x240 cm
LED350W



POL-1967
300x200 cm
LED350W



POL-2978
175x200 cm
LED350W

3D DECORATIONS / DEKORACJE 3D
TREES COMPOSED OF SPHERES / DRZEWA Z KUL

POL-0997
600x280 cm
LED498W

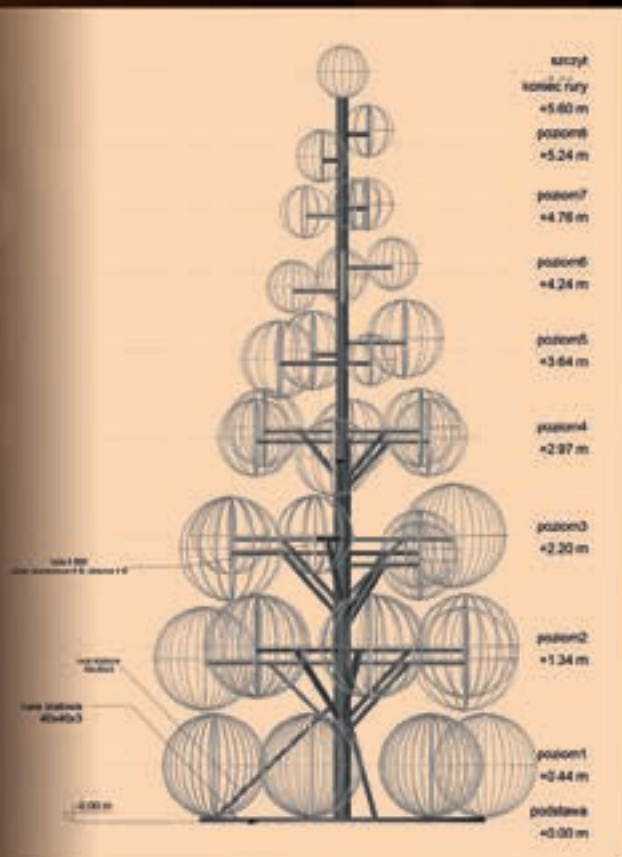

AVAILABLE LED COLOURS / DOSTĘPNE KOLORY LED

cold white, neutral white, warm white, classic white, yellow, orange, pink, purple, red, blue, water blue, green, multicolor, RGB

biały zimny, biały neutralny, biały ciepły, biały klasyczny, żółty, pomarańczowy, różowy, fioletowy, czerwony, niebieski, niebieski morski, zielony, multikolor, RGB



POL-1990
600x220 cm
LED489W



POL-1968
600x220 cm
LED380W

POL-1969
1000x350 cm
LED600W



POL-1800
600x220 cm
LED320W



3D DECORATIONS / DEKORACJE 3D
CHRISTMAS TREES / CHOINKI

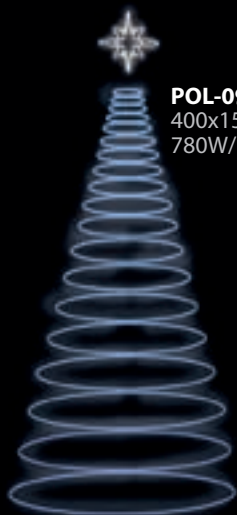

POL-0914
400x150 cm
780W/LED150W



POL-0915
300x115 cm / 600x180 cm
LED150W / LED270W



POL-0916
600x180 cm
LED295W



POL-0919
600x180 cm
LED280W



POL-0918
200x75 cm
425x145 cm
LED189W
LED425W



POL-0917
600x190 cm
1000x245 cm
LED520W
LED915W



POL-1755
300x120 cm
200x80 cm
LED120W
LED90W



POL-1756
300x120 cm
200x80 cm
LED120W
LED90W



POL-1757
300x120 cm
LED190W



POL-1758
300x120 cm
LED190W





POL-0996
500x200 cm / 700x240 cm
LED898W / LED1650W

AVAILABLE LED COLOURS / DOSTĘPNE KOLORY LED

cold white, neutral white, warm white, classic white, yellow, orange, pink, purple, red, blue, water blue, green, multicolor, RGB

biały zimny, biały neutralny, biały ciepły, biały klasyczny, żółty, pomarańczowy, różowy, fioletowy, czerwony, niebieski, niebieski morski, zielony, multikolor, RGB



3D DECORATIONS / DEKORACJE 3D

TREES / DRZEWA

Trees can be standalone decorations that have LED lights wound around them or scattered on the whole trees.

Drzewa mogą być zrealizowane jako osobny obiekt przypominający drzewo, owinięty lampkami LED lub mogą to być lampki bezpośrednio na drzewie.

AVAILABLE LED COLOURS / DOSTĘPNE KOLORY LED

cold white, neutral white, warm white, classic white, yellow, orange, pink, purple, red, blue, water blue, green, multicolor, RGB

biały zimny, biały neutralny, biały ciepły, biały klasyczny, żółty, pomarańczowy, różowy, fioletowy, czerwony, niebieski, niebieski morski, zielony, multikolor, RGB



POL-2979
600x350 cm
LED750W

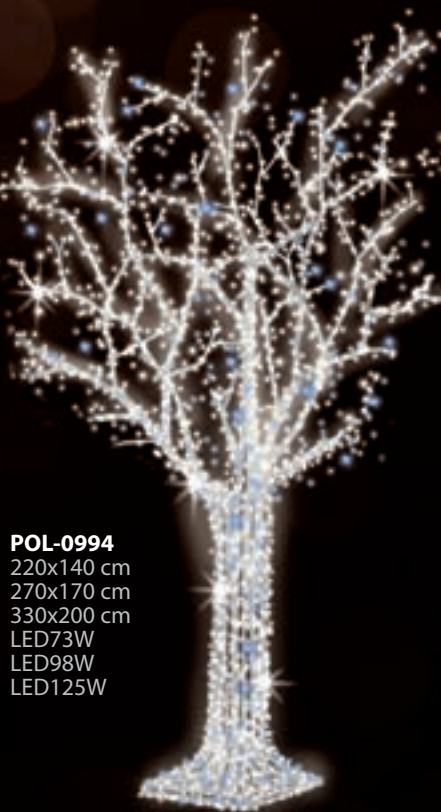

POL-0994
220x140 cm
270x170 cm
330x200 cm
LED73W
LED98W
LED125W

POL-2980
350x180 cm
LED350W



The best way to decorate trees in the winter is to wind LED lights around their trunks and thicker branches as shown in the picture below.

Najlepszym sposobem dekorowania drzew zimą jest owinięcie konaru i grubszych gałęzi lampkami LED jak na ilustracji poniżej.



POL-0995
300x200 cm
400x280 cm
500x350 cm
LED110W
LED145 W
LED311W



3D DECORATIONS / DEKORACJE 3D

SPHERES / KULE PODWIESZANE

Universal 3D decorations are perfect for filling empty spaces of town squares, parks, crossroads, and also interiors of buildings such as hypermarkets or outlets.

Uniwersalne dekoracje 3D idealnie nadają się do wypełniania pustych przestrzeni na miejskich placach, w parkach, na skrzyżowaniach jak i wewnątrz większych budynków np. w hipermarketach i salonach sprzedaży.



POL-0609
Ø 100 cm
LED40W



POL-0650
Ø 100 cm
LED40W



POL-0651
Ø 100 cm
LED40W



POL-0659
200x100 cm
LED75W

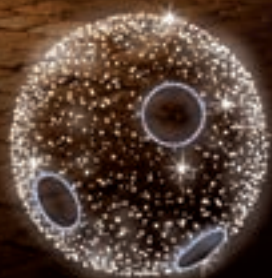

POL-0652
Ø 100 cm
LED40W

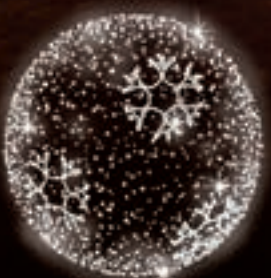

POL-0653
Ø 100 cm
LED40W



POL-0654
Ø 100 cm
LED40W



POL-0655
50x100 cm
LED20W

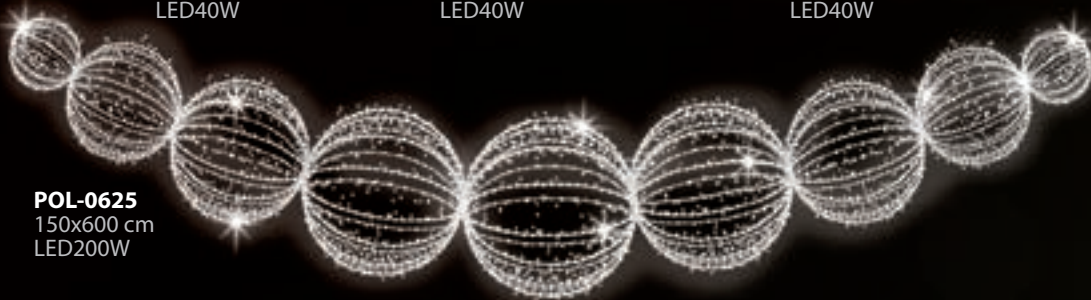

POL-0625
150x600 cm
LED200W

POL-0631
Ø 150 cm
LED165W

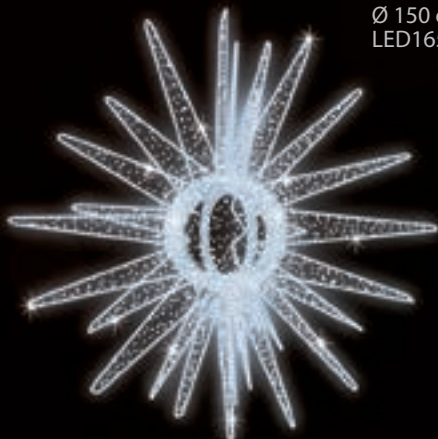

POL-0613
Ø 100 cm
198W/LED40W



POL-0614
Ø 100 cm
198W/LED40W



POL-0615
Ø 100 cm
198W/LED40W

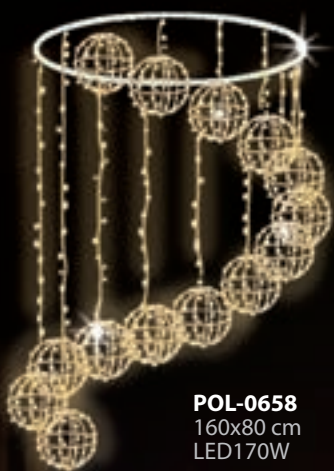

POL-0658
160x80 cm
LED170W



POL-1600
Ø 100 cm
Ø 150 cm
Ø 200 cm
210W/LED42W
294W/LED60W
370W/LED80W



POL-0629
Ø 100 cm
Ø 150 cm
Ø 200 cm
210W/LED42W
294W/LED60W
370W/LED80W



POL-0630
Ø 100 cm
Ø 150 cm
Ø 200 cm
345W/LED69W
570W/LED114W
700W/LED150W



POL-0617
Ø 100 cm
Ø 150 cm
Ø 200 cm
99W/LED21W
147W/LED30W
200W/LED45W



AVAILABLE LED COLOURS / DOSTĘPNE KOLORY LED
cold white, neutral white, warm white, classic white, yellow, orange, pink, purple, red, blue, water blue, green, multicolor, RGB
biały zimny, biały neutralny, biały ciepły, biały klasyczny, żółty, pomarańczowy, różowy, fioletowy, czerwony, niebieski, niebieski morski, zielony, multikolor, RGB



POLE MOUNTED 3D DECOR / DEKORACJE LATARNIOWE 3D
 CHALICES, PALMS / KIELICHY, PALMY



POL-0728
 200x130 cm
 LED250W



POL-0729
 200x130 cm
 LED250W



POL-0743
 200x130 cm
 LED250W



POL-1737
 120x150 cm, LED350W

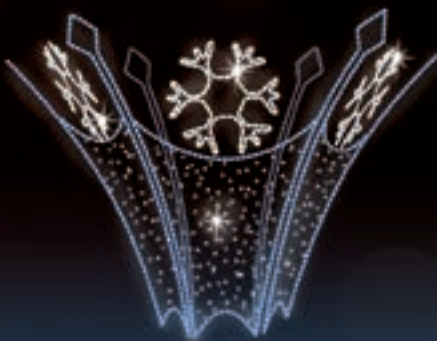

POL-0727
 120x150 cm
 LED290W



POL-1738
 80x120 cm
 LED97W



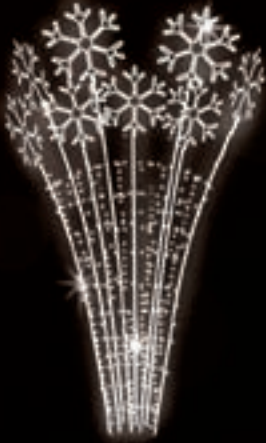

POL-0724
300x200 cm
LED295W



POL-0725
300x200 cm / 200x120 cm
LED515W / LED285W



POL-0726
175x95 cm
LED185W

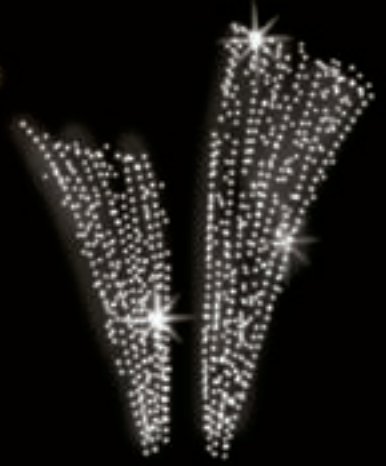

POL-0723
150x80 cm
LED38W



POL-1733
300x200 cm / 200x120 cm
LED515W / LED285W



POL-1734
300x200 cm / 200x120 cm
LED515W / LED285W



POL-1735
280x200 cm / 200x120 cm
LED515W / LED285W



POL-1736
300x200 cm / 200x120 cm
LED515W / LED285W

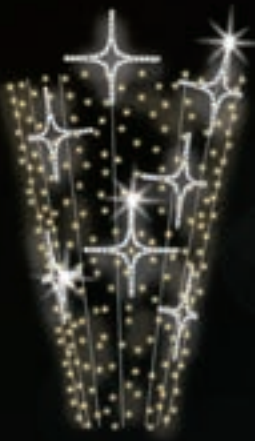

POL-0746
300x200 cm / 200x120 cm
LED285W / LED515W



POL-0745
300x200 cm / 200x120 cm
LED285W / LED515W



AVAILABLE LED COLOURS / DOSTĘPNE KOLORY LED

cold white, neutral white, warm white, classic white, yellow, orange, pink, purple, red, blue, water blue, green, multicolor, RGB

biały zimny, biały neutralny, biały ciepły, biały klasyczny, żółty, pomarańczowy, różowy, fioletowy, czerwony, niebieski, niebieski morski, zielony, multikolor, RGB



POLE MOUNTED 3D DECOR / DEKORACJE LATARNIOWE 3D
 CHALICES / KIELICHY Z ORNAMENTEM



POL-1740
 300x100 cm
 LED167W



POL-1740B
 300x100 cm
 LED167W



POL-1740M
 300x100 cm
 LED175W



POL-1741
 300x100 cm
 LED180W



POL-1741MB
 300x100 cm
 LED185W



POL-1742
 300x100 cm
 LED210W



POL-1743
 300x100 cm
 LED210W

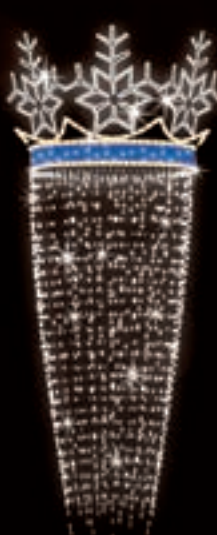

POL-1744
 300x90 cm
 LED210W

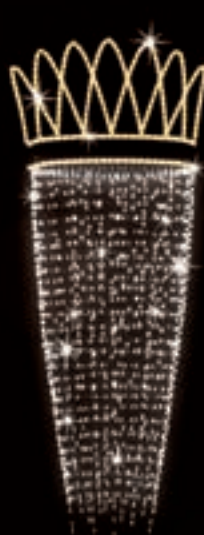

POL-1745
 300x90 cm
 LED188W

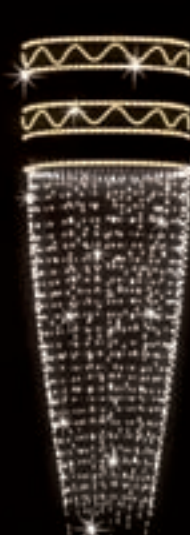

POL-1746
 300x80 cm
 LED188W



POL-1020
 300x100 cm
 LED210W



POL-1747
 280x80 cm
 LED188W



POL-1748
 300x120 cm
 LED265W



POL-1749
 310x120 cm
 LED265W



POL-1750
 310x120 cm
 LED265W

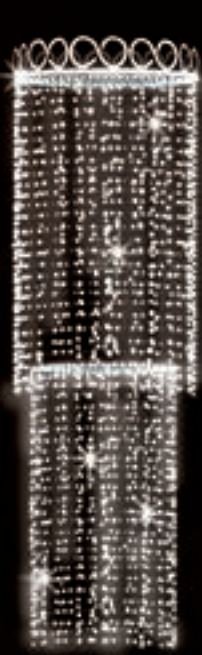

POL-0740
300x140 cm
LED275W



POL-0741
300x140 cm
LED225W

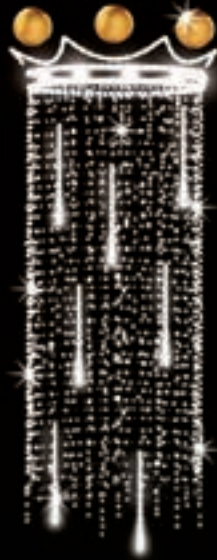

POL-1708
300x140 cm
LED275W



POL-0742
200x80 cm
LED135W



POL-0744
250x100 cm
LED180W



Enhance your decoration with PVC ornaments, if you're interested, make sure to check out our selection of PVC baubles, stars and bows.

Coraz większą popularnością cieszą się dekoracje ozdobione bombkami. Prosimy o szczegółowe zapoznanie się z naszą ofertą ozdób z PCV takich jak bombki, gwiazdki, kokardy.



Meteorite shower lights produce a visually stunning effect of animated descending strings of light.

W przypadku meteorków możemy zaobserwować tzw. „efekt spadającego światła”.

POL-1021
450x100 cm
LED375W

POL-1022
450x100 cm
LED375W

POL-1023
450x100 cm
LED375W

POL-1024
450x100 cm
LED375W

POL-1025
450x100 cm
LED375W

POL-1026
500x100 cm
LED375W

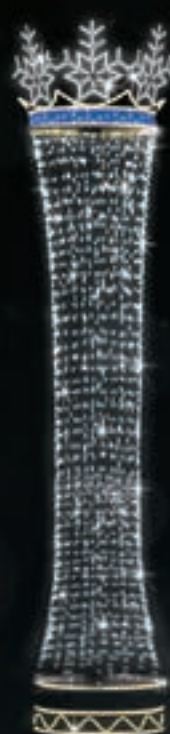
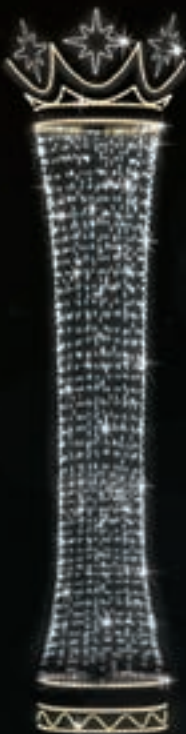

POLE MOUNTED 3D DECOR / DEKORACJE LATARNIOWE 3D
CYLINDERS WITH ORNAMENT / WALCE Z ORNAMENTEM



POL-1027
310x90 cm
LED225W



POL-1028
310x90 cm
LED225W



POL-1029
320x90 cm
LED225W



POL-1030
300x100 cm
LED225W

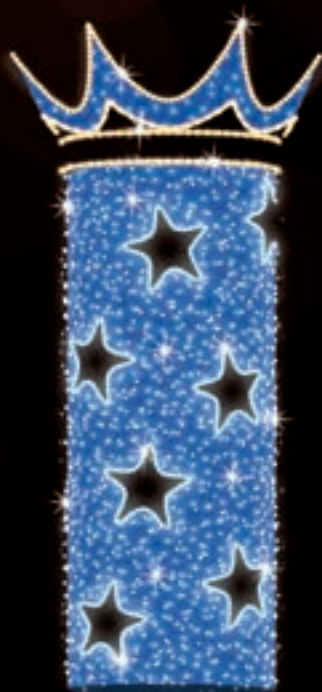

POL-0750
300x90 cm
LED225W



POL-0751
280x80 cm
LED195W

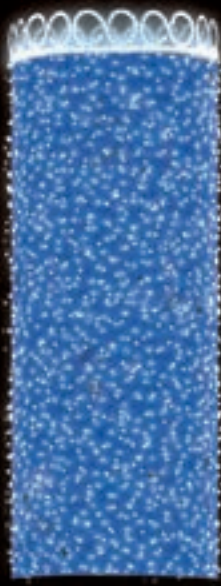

POL-0752
280x80 cm
LED160W

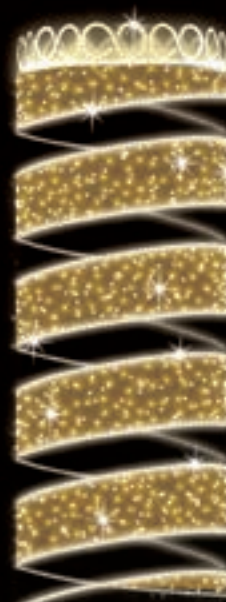

POL-0753
280x80 cm
LED150W

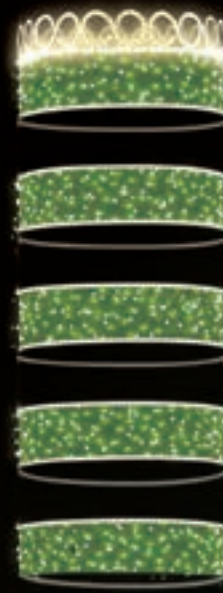

POL-0754
280x80 cm
LED150W

AVAILABLE LED COLOURS / DOSTĘPNE KOLORY LED

cold white, neutral white, warm white, classic white, yellow, orange, pink, purple, red, blue, water blue, green, multicolor, RGB

biały zimny, biały neutralny, biały ciepły, biały klasyczny, żółty, pomarańczowy, różowy, fioletowy, czerwony, niebieski, niebieski morski, zielony, multikolor, RGB



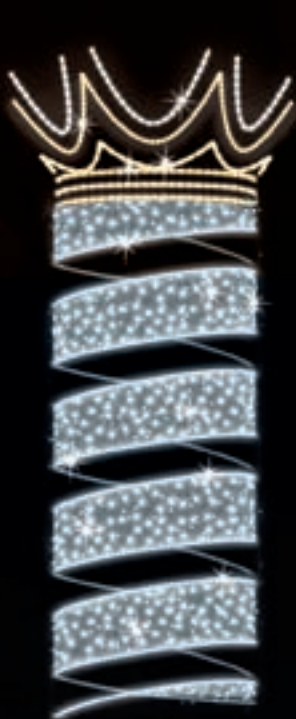

POL-0755
310x90 cm
LED225W



POL-0756
320x90 cm
LED225W

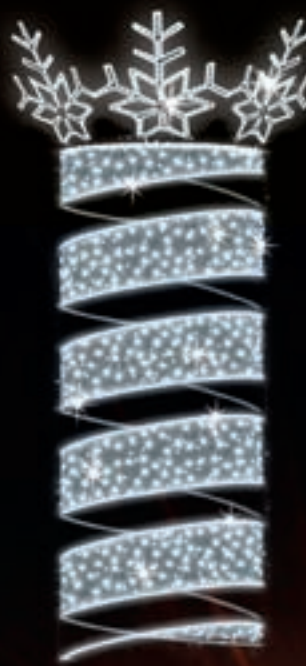

POL-0757
300x100 cm
LED275W

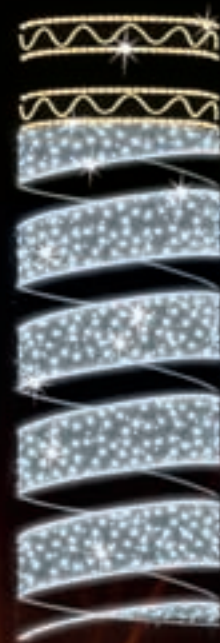

POL-0758
300x80 cm
LED275W

AVAILABLE LED COLOURS / DOSTĘPNE KOLORY LED

cold white, neutral white, warm white, classic white, yellow, orange, pink, purple, red, blue, water blue, green, multicolor, RGB

biały zimny, biały neutralny, biały ciepły, biały klasyczny, żółty, pomarańczowy, różowy, fioletowy, czerwony, niebieski, niebieski morski, zielony, multicolor, RGB



POLE MOUNTED 3D DECOR / DEKORACJE LATARNIOWE 3D
CYLINDERS WITH ORNAMENT / WALCE Z ORNAMENTEM



POL-1709
220x90 cm, LED135W



POL-1710
220x90 cm, LED160W



POL-1709M
220x90 cm, LED135W



POL-1711
220x90 cm, LED141W



POL-1711MB
220x90 cm, LED135W



POL-1709B
220x90 cm, LED135W



POL-1712
225x95 cm, LED165W



POL-1713
225x95 cm, LED165W



POL-1714
225x85 cm, LED165W



POL-1724
260x90 cm, LED168W



POL-1721
320x170 cm, LED285W



POL-1722
320x170 cm, LED285W



POL-1723
320x170 cm, LED285W



POL-1725
260x80 cm, LED168W



POL-1726
180x80 cm, LED168W

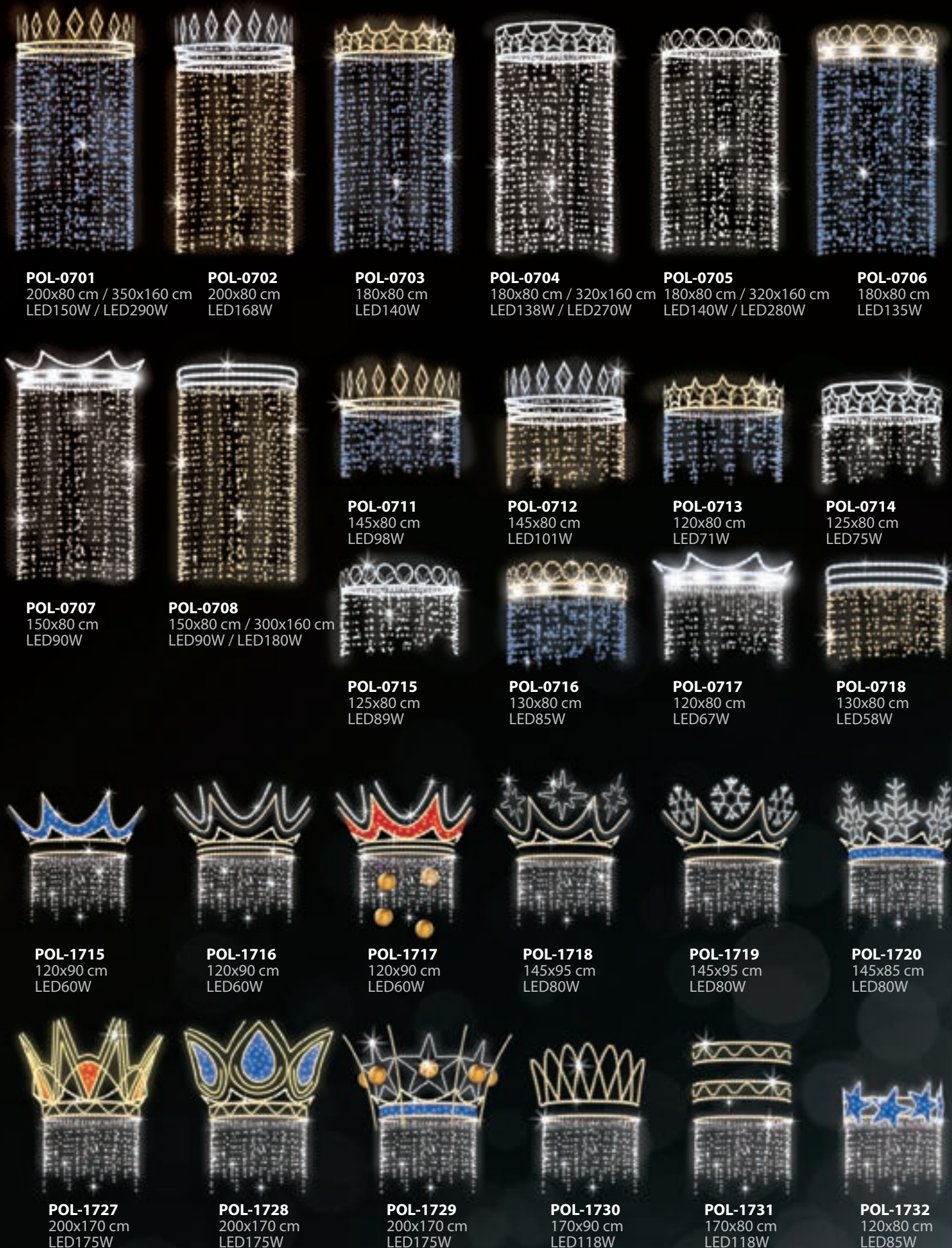

POL-0701

200x80 cm / 350x160 cm
LED150W / LED290W

POL-0702

200x80 cm
LED168W

POL-0703

180x80 cm
LED140W

POL-0704

180x80 cm / 320x160 cm
LED138W / LED270W

POL-0705

180x80 cm / 320x160 cm
LED140W / LED280W

POL-0706

180x80 cm
LED135W

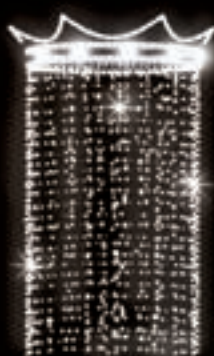

POL-0707

150x80 cm
LED90W

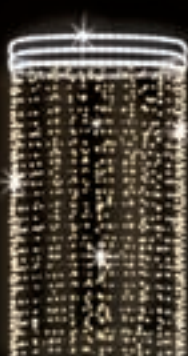

POL-0708

150x80 cm / 300x160 cm
LED90W / LED180W

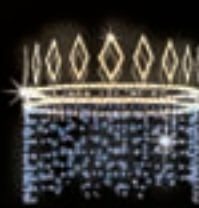

POL-0711

145x80 cm
LED98W



POL-0712

145x80 cm
LED101W



POL-0713

120x80 cm
LED71W



POL-0714

125x80 cm
LED75W



POL-0715

125x80 cm
LED89W



POL-0716

130x80 cm
LED85W



POL-0717

120x80 cm
LED67W



POL-0718

130x80 cm
LED58W



POL-1715

120x90 cm
LED60W



POL-1716

120x90 cm
LED60W



POL-1717

120x90 cm
LED60W



POL-1718

145x95 cm
LED80W



POL-1719

145x95 cm
LED80W



POL-1720

145x85 cm
LED80W



POL-1727

200x170 cm
LED175W



POL-1728

200x170 cm
LED175W



POL-1729

200x170 cm
LED175W



POL-1730

170x90 cm
LED118W



POL-1731

170x80 cm
LED118W



POL-1732

120x80 cm
LED85W

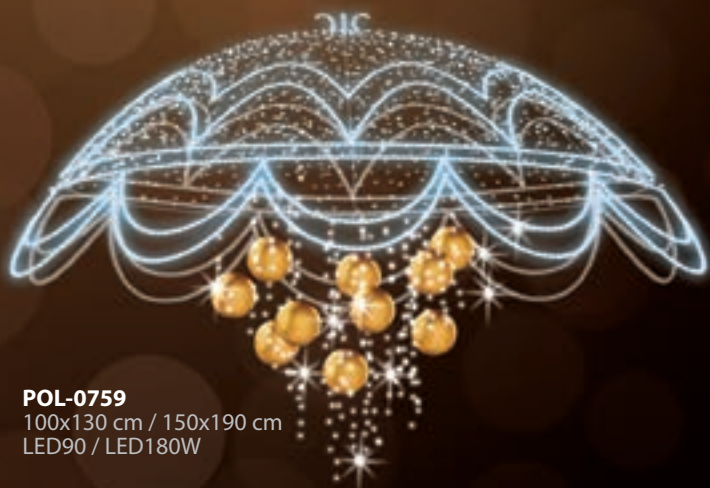

POL-0759
 100x130 cm / 150x190 cm
 LED90 / LED180W



POL-0760
 50x120 cm / 80x180 cm
 LED90 / LED180W



POL-0761
 80x120 cm / 120x180 cm
 LED85W / LED178W



POL-0762
 50x120 cm / 80x180 cm
 LED90 / LED180W



POL-1753
 80x120 cm / 120x180 cm
 LED85W / LED178W



POL-0763
 150x120 cm / 210x180 cm
 LED110 / LED220W



POL-1751
80x120 cm / 120x180 cm
LED85W / LED178W



POL-1752
80x120 cm / 120x180 cm
LED85W / LED178W



POL-0764
50x120 cm / 80x180 cm
LED95W / LED190W



POL-0765
100x120 cm / 150x180 cm
LED90W / LED180W

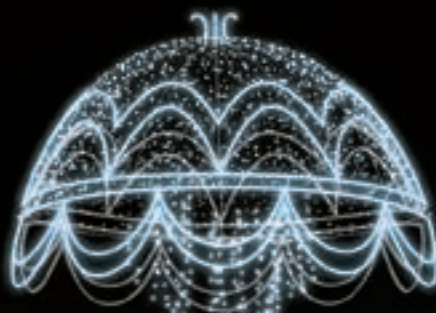

POL-0766
120x120 cm / 180x180 cm
LED100W / LED200W

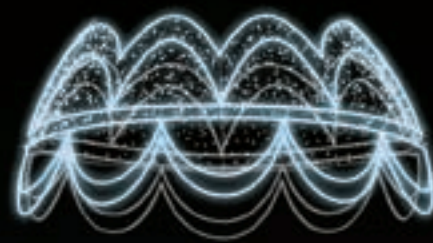

POL-0767
50x120 cm / 80x180 cm
LED80W / LED175W



AVAILABLE LED COLOURS / DOSTĘPNE KOLORY LED
cold white, neutral white, warm white, classic white, yellow, orange, pink, purple,
red, blue, water blue, green, multicolor, RGB

biały zimny, biały neutralny, biały ciepły, biały klasyczny, żółty, pomarańczowy, różowy,
fioletowy, czerwony, niebieski, niebieski morski, zielony, multicolor, RGB



POLE MOUNTED 3D DECOR / DEKORACJE LATARNIOWE 3D
 SHADES, CROWNS / LAMPIONY, KORONY



POL-0768
 200x320 cm
 LED175W



POL-0776
 200x320 cm
 LED175W

POL-1034
 150x100 cm
 LED85W

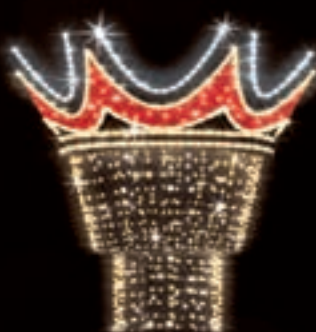

POL-0770
 200x300 cm
 LED180W



POL-0771
 300x125 cm
 LED225W

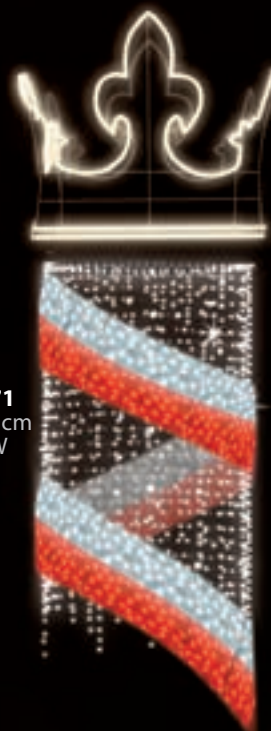

POL-0769
 150x150 cm
 LED90W



POL-1754
 100x140 cm
 LED80W



POL-0773
 300x125 cm
 LED225W



POL-0772
 300x125 cm
 LED235W



AVAILABLE LED COLOURS

cool white, warm white, yellow, orange, pink, purple, red, blue,
 water blue, green, multicolor





POL-0719
 90x80 cm
 LED80W



POL-0774
 300x230 cm
 LED185W



POL-0775
 330x230 cm
 LED185W

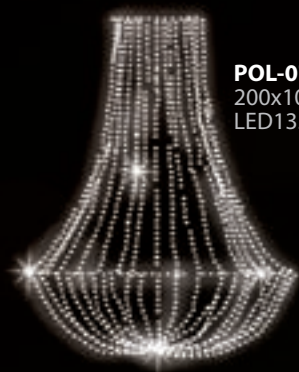

POL-0721
 200x100 cm
 LED135W



AVAILABLE LED COLOURS / DOSTĘPNE KOLORY LED
 cold white, neutral white, warm white, classic white, yellow, orange, pink, purple,
 red, blue, water blue, green, multicolor, RGB
 biały zimny, biały neutralny, biały ciepły, biały klasyczny, żółty, pomarańczowy, różowy,
 fioletowy, czerwony, niebieski, niebieski morski, zielony, multikolor, RGB



POLE MOUNTED 3D DECOR / DEKORACJE LATARNIOWE 3D
 CHANDELIERS / ZYRANDOLE

POL-0816
 180x90cm
 LED185W



POL-0817
 180x90 cm
 LED215W



POL-0818
 180x90 cm
 LED215W



POL-0819
 100x75 cm
 LED150W



POL-0820
 120x75 cm
 LED150W



POL-0821
 120x75 cm
 LED200W



POL-0822
 80x120 cm
 LED85W



POL-0823
 80x120 cm
 LED85W

AVAILABLE LED COLOURS / DOSTĘPNE KOLORY LED

cold white, neutral white, warm white, classic white, yellow, orange, pink, purple, red, blue, water blue, green, multicolor, RGB

biały zimny, biały neutralny, biały ciepły, biały klasyczny, żółty, pomarańczowy, różowy, fioletowy, czerwony, niebieski, niebieski morski, zielony, multikolor, RGB



PVC baubles add depth to flat light decorations. Their highly lustrous surface reflects LED light, increasing decoration's luminosity. Use them to liven up any decoration and highlight its colours.

Bombki PCV dzięki wysokiemu połyskowi znakomicie odbijają światło lampek LED przez co potęgują moc światła. Dzięki nim ozdoby wyglądają na żywsze i bardziej kolorowe.





POL-0811
300x200 cm
LED450W



POL-0812
300x300 cm
LED475W



POL-0813
300x220 cm
LED350W

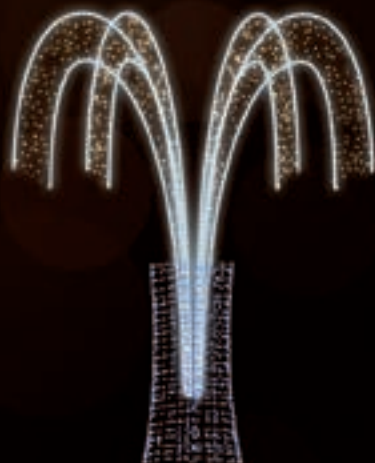

POL-0814
300x120 cm
LED285W



POL-0815
300x120 cm
LED285W



POL-0805
300x260 cm
1500W/LED300W



POL-0807
200x200 cm
1244W/LED260W



POL-0806
300x200 cm
1520W/LED300W



POL-0808
150x150 cm
1023W/LED212W



POL-0803
300x150 cm
1830W/LED360W



POL-0802
300x150 cm
1300W/LED260W



POL-0809M
300x185 cm
1839W/LED360W



POL-0810
Ø 150-300 cm
212LEDW



POL-0747
200x125 cm
LED105W



POL-0748
100x70x70 cm
LED80W



POL-0722
80x160 cm
387W/LED78W



POL-0749
80x160 cm
390W/LED80W

These 3D multi-style pole mounted ornaments illustrate how several identical motifs may be combined to form a magnificent three-dimensional street light decoration. The number of individual components can be adjusted as needed. The decoration can be mounted so that it surrounds only street light's light cover or pole.

Dekoracje latarniowe 3D multi to doskonały przykład jak z kilku tych samych ozdób płaskich możemy zrobić efektowną dekorację przestrzenną. Dekoracja może być zwielokrotniona w zależności od zapotrzebowania. Może okalać zarówno sam klosz latarni jak i słup.



AVAILABLE LED COLOURS / DOSTĘPNE KOLORY LED

cold white, neutral white, warm white, classic white, yellow, orange, pink, purple, red, blue, water blue, green, multicolor, RGB

biały zimny, biały neutralny, biały ciepły, biały klasyczny, żółty, pomarańczowy, różowy, fioletowy, czerwony, niebieski, niebieski morski, zielony, multikolor, RGB



OVERHANGS / PRZEWIESZKI



POL-0361
250x950 cm
LED275W



POL-0362
175x1050 cm
LED275W



POL-0363
200x800 cm
LED250W



POL-0364
175x900 cm
LED250W



POL-0365
120x950 cm
LED215W



POL-0366
175x900 cm
LED225W



AVAILABLE LED COLOURS / DOSTĘPNE KOLORY LED

cold white, neutral white, warm white, classic white, yellow, orange, pink, purple, red, blue, water blue, green, multicolor, RGB

biały zimny, biały neutralny, biały ciepły, biały klasyczny, żółty, pomarańczowy, różowy, fioletowy, czerwony, niebieski, niebieski morski, zielony, multikolor, RGB





POL-1306
150x600 cm, LED280W



POL-1304
175x600 cm, LED250W



POL-1305
175x600 cm, LED300W



POL-1302
150x600 cm, LED150W

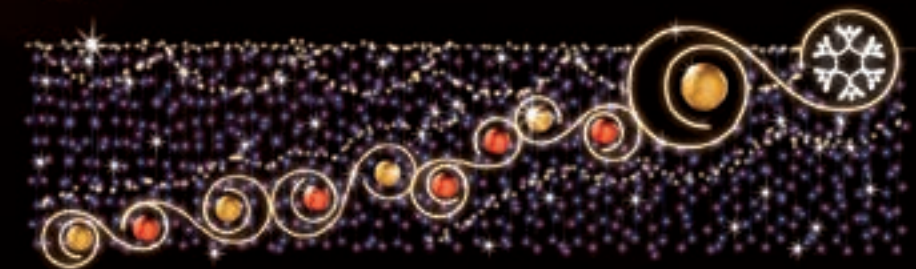

POL-1303
150x600 cm, LED165W



POL-1300
180x600 cm, LED400W



POL-1301
180x600 cm, LED350W

AVAILABLE LED COLOURS / DOSTĘPNE KOLORY LED

cold white, neutral white, warm white, classic white, yellow, orange, pink, purple,
red, blue, water blue, green, multicolor, RGB

biały zimny, biały neutralny, biały ciepły, biały klasyczny, żółty, pomarańczowy, różowy,
fioletowy, czerwony, niebieski, niebieski morski, zielony, multikolor, RGB





POL-1324
100x700 cm
LED85W



POL-1325M
120x900 cm
LED95W



POL-1326M
120x900 cm
LED130W

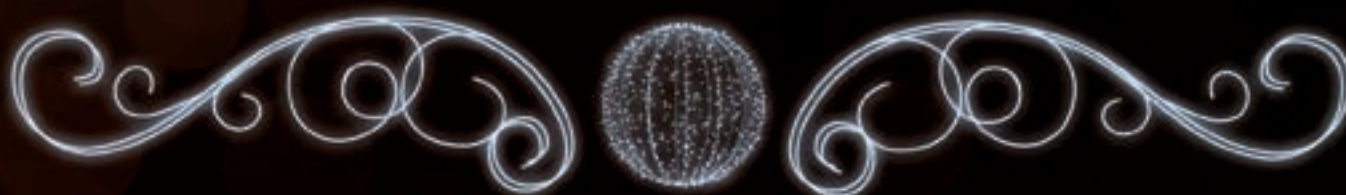

POL-1327
100x700 cm
LED92W



POL-1328
120x750 cm
LED135W



POL-1329
135x800 cm
LED110W

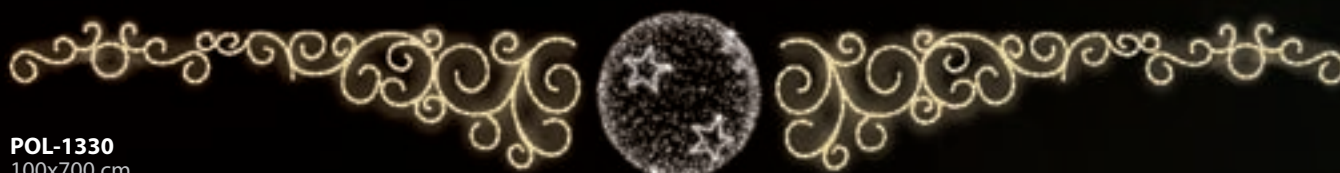

POL-1330
100x700 cm
LED95W



AVAILABLE LED COLOURS / DOSTĘPNE KOLORY LED
 cold white, neutral white, warm white, classic white, yellow, orange, pink, purple,
 red, blue, water blue, green, multicolor, RGB

biały zimny, biały neutralny, biały ciepły, biały klasyczny, żółty, pomarańczowy, różowy,
 fioletowy, czerwony, niebieski, niebieski morski, zielony, multikolor, RGB



OVERHANGS / PRZEWIESZKI



Over-the-street ornaments can be delivered disassembled.

Przewieszki mogą być dostarczone w częściach.



POL-0350
130x500 cm
LED128W



POL-0351
200x750 cm
LED189W



POL-0313
150x600 cm
796W/LED165W



AVAILABLE LED COLOURS / DOSTĘPNE KOLORY LED

cold white, neutral white, warm white, classic white, yellow, orange, pink, purple, red, blue, water blue, green, multicolor, RGB

biały zimny, biały neutralny, biały ciepły, biały klasyczny, żółty, pomarańczowy, różowy, fioletowy, czerwony, niebieski, niebieski morski, zielony, multicolor, RGB



POL-0309
110x450 cm
510W/LED105W



POL-0323
120x600 cm
895W/LED175W

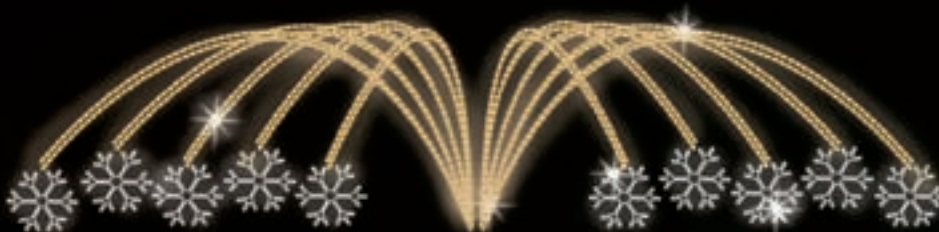

POL-0321
130x600 cm
935W/LED195W



POL-0319
120x600 cm
1380W/LED280W



POL-0322
75x350 cm
130x600 cm
496W/LED99W



POL-0326
80x600 cm
625W/LED117W



POL-0352
20x450 cm
LED104W





POL-0310
100x400 cm
320W/LED65W



POL-0311
100x400 cm
386W/LED80W



POL-0316
130x600 cm
620W/LED125W



POL-0320
100x600 cm
400W/LED82W



POL-0318
60x600 cm
230W/LED67W



POL-0333
65x600 cm
LED140W



POL-0390
100x900 cm
LED169W



POL-0334
70x400 cm
380W/LED76W

AVAILABLE LED COLOURS / DOSTĘPNE KOLORY LED

cold white, neutral white, warm white, classic white, yellow, orange, pink, purple, red, blue, water blue, green, multicolor, RGB

biały zimny, biały neutralny, biały ciepły, biały klasyczny, żółty, pomarańczowy, różowy, fioletowy, czerwony, niebieski, niebieski morski, zielony, multikolor, RGB



POL-0314
120x300 cm
380W/LED80W



POL-0315
100x500 cm
389W/LED80W



POL-0324
120x600 cm
670W/LED138W



POL-0325
120x600 cm
680W/LED140W



POL-0336
100x600 cm
LED162W



POL-0360
125x500 cm
LED192W

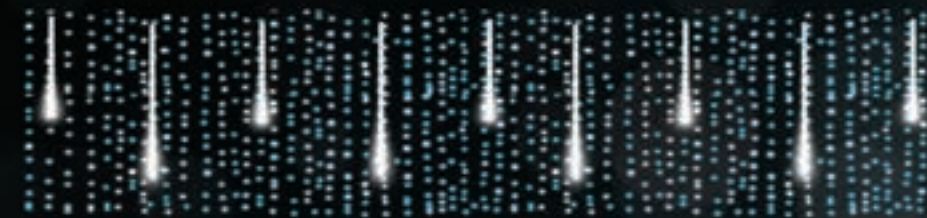

POL-0399
150x500 cm
LED192W





POL-0328
150x500 cm
LED200W



POL-0329
150x500 cm
LED200W



POL-0330
150x500 cm
LED200W

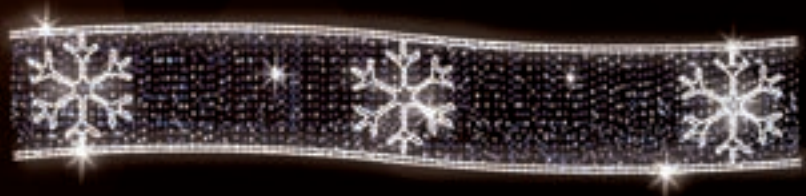

POL-0331
45x500 cm
LED170W

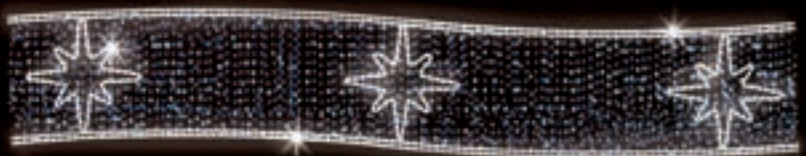

POL-0332
50x400 cm
LED160W



POL-0339
100x500 cm
LED210W



POL-0340
120x500 cm
LED240W

POL-0327
100x350 cm
700W/LED140W



POL-0341
100x500 cm
LED175W



POL-0342
100x500 cm
LED199W



AVAILABLE LED COLOURS / DOSTĘPNE KOLORY LED
cold white, neutral white, warm white, classic white, yellow, orange, pink, purple, red, blue, water blue, green, multicolor, RGB

biały zimny, biały neutralny, biały ciepły, biały klasyczny, żółty, pomarańczowy, różowy, fioletowy, czerwony, niebieski, niebieski morski, zielony, multicolor, RGB



OVERHANGS / PRZEWIESZKI
 SYMMETRICAL /W ORNAMENT / SYMETRYCZNE Z ORNAMENTEM



POL-1322
 150x600 cm, LED300W



POL-1323
 100x600 cm, LED350W



POL-1307
 150x700 cm, LED335W



POL-1308
 120x600 cm, LED320W



POL-1309
 120x600 cm, LED315W

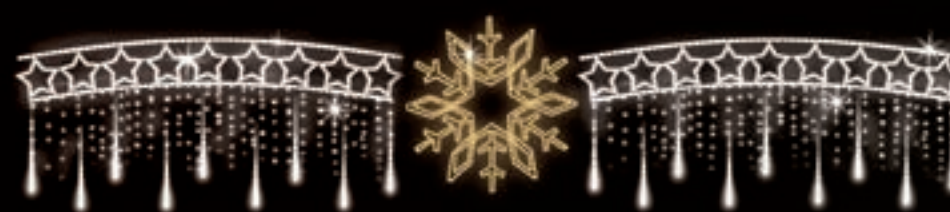

POL-1310
 120x600 cm, LED340W



POL-1311
 120x600 cm, LED300W



Meteorite shower lights produce a visually stunning effect of animated-descending strings of light. They may be installed on rooftops, windows, facades. They're ideal for any landscaping project and look beautiful on trees. Available in cool white.

W przypadku meteorków możemy zaobserwować tzw. „efekt spadającego światła”. Daje to nam niesamowity widok. Można je stosować do zdobienia dachów, okien, elewacji oraz do dowolnej aranżacji przestrzeni. Szczególnie dobrze wyglądają rozwieszane na drzewach. Występują w kolorze białym zimnym.

AVAILABLE LED COLOURS / DOSTĘPNE KOLORY LED
cold white, neutral white, warm white, classic white, yellow, orange, pink, purple, red, blue, water blue, green, multicolor, RGB

biały zimny, biały neutralny, biały ciepły, biały klasyczny, żółty, pomarańczowy, różowy, fioletowy, czerwony, niebieski, niebieski morski, zielony, multicolor, RGB



OVERHANGS / PRZEWIESZKI
 SYMMETRICAL / SYMETRYCZNE

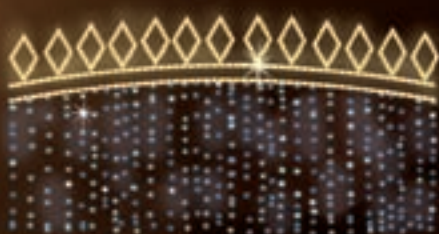

POL-0391
 140x520 cm
 LED150W



POL-0392
 150x520 cm
 LED181W



POL-0393
 130x520 cm
 LED129W



POL-0394
 130x520 cm
 LED135W



POL-0395
 130x520 cm
 LED142W

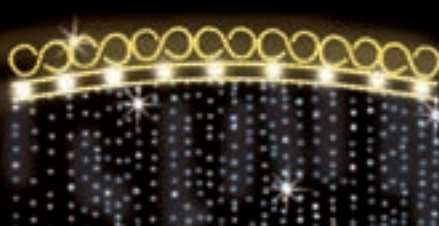

POL-0396
 140x520 cm
 LED158W

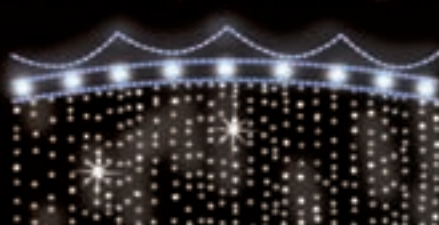

POL-0397
 140x520 cm
 LED94W

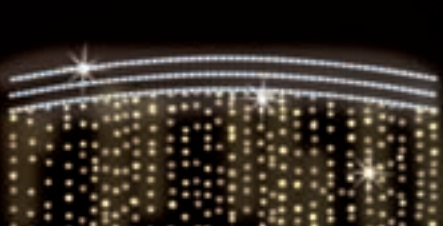

POL-0398
 130x520 cm
 LED92W

OVERHANGS / PRZEWIESZKI

SYMMETRICAL / SYMETRYCZNE

AVAILABLE LED COLOURS / DOSTĘPNE KOLORY LED

cold white, neutral white, warm white, classic white, yellow, orange, pink, purple, red, blue, water blue, green, multicolor, RGB

biały zimny, biały neutralny, biały ciepły, biały klasyczny, żółty, pomarańczowy, różowy, fioletowy, czerwony, niebieski, niebieski morski, zielony, multikolor, RGB



OVERHANGS / PRZEWIESZKI
VARIOUS WITH MAT / RÓŻNE Z MATĄ



POL-0311M
100x400 cm
LED92W



POL-0322M
75x350 cm
130x600 cm
LED135W



POL-0356M
190x600 cm
LED195W



POL-0357M
190x600 cm
LED195W



POL-0353M
120x600 cm
LED108W



POL-0354M
100x500 cm
LED97W



POL-0355M
100x700 cm
LED110W



AVAILABLE LED COLOURS / DOSTĘPNE KOLORY LED

cold white, neutral white, warm white, classic white, yellow, orange, pink, purple, red, blue, water blue, green, multicolor, RGB

biały zimny, biały neutralny, biały ciepły, biały klasyczny, żółty, pomarańczowy, różowy, fioletowy, czerwony, niebieski, niebieski morski, zielony, multikolor, RGB



POL-0330M
150x500 cm
LED230W



POL-0329M
150x500 cm
LED230W



Wesołych Świąt

POL-1313
80x450 cm
500W/LED100W

3 Hołubim Pokon!

POL-1314
100x400 cm
850W/LED175W

Merry Christmas

POL-1315
80x500 cm
650W/LED130W

Glückliches Neues Jahr

POL-1316
65x600 cm
760W/LED155W

Wesołych Świąt

POL-1317
80x400 cm
500W/LED100W

Bóg się rodzi

POL-1318
85x400 cm
400W/LED80W

Szczęśliwego
Nowego Roku

POL-1319
140x400 cm
800W/LED160W

 *Wesołych Świąt*

 *Wesołych Świąt* 

 *Wesołych Świąt* 

AVAILABLE LED COLOURS / DOSTĘPNE KOLORY LED

cold white, neutral white, warm white, classic white, yellow, orange, pink, purple, red, blue, water blue, green, multicolor, RGB

biały zimny, biały neutralny, biały ciepły, biały klasyczny, żółty, pomarańczowy, różowy, fioletowy, czerwony, niebieski, niebieski morski, zielony, multikolor, RGB



Christmas / New Year greetings signs available in several languages. Custom signs /w custom font made on request.

W ofercie posiadamy świąteczne i noworoczne napisy w kilku językach. Na specjalne zamówienie wykonujemy napisy dowolną wskazaną czcionką oraz życzeniem.

Szczęśliwego Nowego Roku

POL-0301
65x800 cm
880W/LED165W

Wesołych Świąt

POL-0302
65x600 cm
680W/LED140W

Wesołych Świąt

POL-0303
65x600 cm
375W/LED141W

Wesołych Świąt

POL-0304
80x500
840W/LED170W

Lodowisko

POL-0307
100x600 cm
680W/LED140W

2020 2020

POL-0308
100x280 cm
380W/LED77W

POL-1321
100x300 cm
750W/LED150W

2020

POL-0358
200x500 cm
LED200W



POL-0345
150x300 cm
LED76W



POL-0346
250x500 cm
LED200W

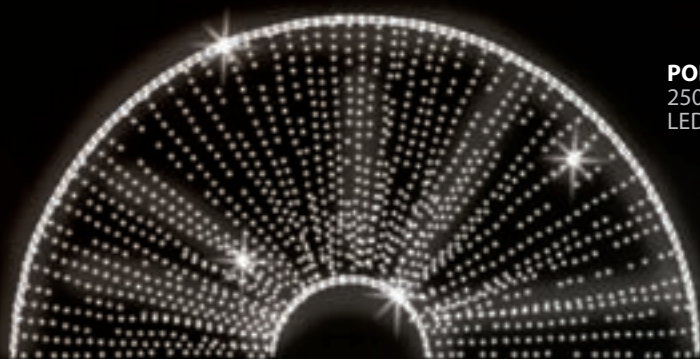

AVAILABLE LED COLOURS / DOSTĘPNE KOLORY LED

cold white, neutral white, warm white, classic white, yellow, orange, pink, purple,
red, blue, water blue, green, multicolor, RGB

biały zimny, biały neutralny, biały ciepły, biały klasyczny, żółty, pomarańczowy, różowy,
fioletowy, czerwony, niebieski, niebieski morski, zielony, multicolor, RGB



OVERHANGS / PRZEWIESZKI
FOLKSY / MOTYWY LUDOWE



POL-0371
170x900 cm
LED230W



POL-0372
170x900 cm
LED285W



POL-0373
170x1050 cm
LED245W



POL-0374
170x1050 cm
LED240W



POL-0375
170x1050 cm
LED225W



POL-1120
250x75 cm
LED85W



POL-1121
300x100 cm
LED120W



POL-1122
200x160 cm
LED115W

POL-1123
150x125 cm
LED45W



POL-1124
150x60 cm
LED50W



POL-1125
250x320 cm
LED75W



POL-1126
200x110 cm
LED70W



POL-1127
200x110 cm
LED70W



POL-1128
170x170 cm
LED60W



POL-1129
150x150 cm
LED60W



AVAILABLE LED COLOURS / DOSTĘPNE KOLORY LED

cold white, neutral white, warm white, classic white, yellow, orange, pink, purple, red, blue, water blue, green, multicolor, RGB

biały zimny, biały neutralny, biały ciepły, biały klasyczny, żółty, pomarańczowy, różowy, fioletowy, czerwony, niebieski, niebieski morski, zielony, multicolor, RGB





POL-0232M
 155x100 cm
 LED40W



POL-0233
 180x95 cm
 LED57W



POL-0253
 155x100 cm
 LED40W



POL-0231
 150x90 cm
 LED44W



POL-0232
 155x100 cm
 LED40W



POL-0251
 155x100 cm
 LED40W



POL-0252
 155x100 cm
 LED40W



POL-0255
 155x100 cm
 LED40W



POL-0256
 155x100 cm
 LED40W



POL-0257
 155x100 cm
 LED40W



POL-0254
 155x100 cm
 LED40W



POL-1253
 200x130 cm
 LED110W



POL-1254
 200x130 cm
 LED100W



POL-1255
 200x130 cm
 LED105W



POL-1256
 200x130 cm
 LED110W

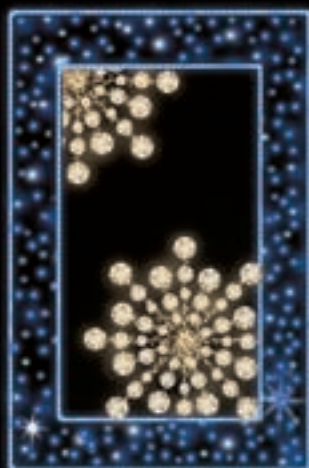

POL-1257
 200x130 cm
 LED65W



POL-1240
 185x120 cm
 LED79W



POL-1241
 185x120 cm
 LED82W



POL-1242
 185x120 cm
 LED80W

AVAILABLE LED COLOURS / DOSTĘPNE KOLORY LED

cold white, neutral white, warm white, classic white, yellow, orange, pink, purple, red, blue, water blue, green, multicolor, RGB

biały zimny, biały neutralny, biały ciepły, biały klasyczny, żółty, pomarańczowy, różowy, fioletowy, czerwony, niebieski, niebieski morski, zielony, multicolor, RGB



POLE MOUNTED DECOR / DEKORACJE LATARNIOWE
WITH METEORITE SHOWER / Z METEORKAMI



POL-1258
220x120 cm
LED60W



POL-1259
220x120 cm
LED60W



POL-1220
220x120 cm
LED60W



POL-1221
220x120 cm
LED60W



POL-1222
220x120 cm
LED60W



POL-1223
220x120 cm
LED60W



POL-0248
220x120 cm
LED60W



POL-0249
220x120 cm
LED60W



POL-0250
220x120 cm
LED60W



POL-1224
220x120 cm
LED60W



POLE MOUNTED DECOR / DEKORACJE LATARNIOWE COMETS, SNOWFLAKES & STARS /W CURTAIN

KOMETY, ŚNIEŻYNKI I GWIAZDY Z KURTYNAMI

KOMETY, ŚNIEŻYNKI I GWIAZDY Z KURTYNAMI



POL-1228
450x120 cm
LED123W



POL-1229
300x90 cm
LED90W



POL-1230
300x125cm
LED168W



POL-1225
250x120 cm
LED72W



POL-1226
250x120 cm
LED74W



POL-1227
200x90 cm
LED53W



POL-1231
400x120 cm
LED91W

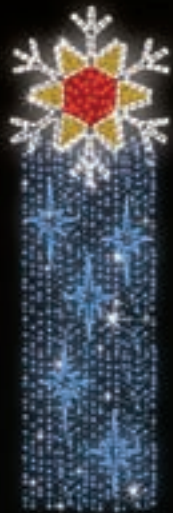

POL-1233
300x90 cm
LED88W



POL-1234
300x90 cm
LED92W



POL-1232
400x120 cm
LED120W



POL-1238
300x120 cm
LED142W



POL-1235
300x90 cm
LED93W



POL-1236
300x120 cm
LED100W



POL-1237
400x150 cm
LED160W

Not unlike Xmas trees, other light ornaments may be animated. Such ornaments look especially amazing with the meteorite shower effect. A remote controlled microcontroller may be used to manage the display.

Dekoracje świetlne podobnie jak choinki mogą mieć animowane oświetlenie. Do tego celu idealnie nadają się meteorki z efektem spadającego światła. Całość może być sterowana za pomocą specjalnego sterownika i pilota.



POL-1260
300x150 cm
LED135W



POL-1261
300x150 cm
LED95W



POL-1262
300x150 cm
LED95W



POL-1263
300x150 cm
LED90W



POL-1264
300x150 cm
LED92W



POL-1265
300x150 cm
LED100W

AVAILABLE LED COLOURS

cool white, warm white, yellow, orange, pink, purple, red, blue,
water blue, green, multicolor



Large illuminations composed of simple ornaments are perfect decorations for tall lamp posts. The height of these illuminations reaches up to 3 metres, which makes them visible from a long distance. Thanks to a wide range of elements belonging to such categories as for example stars and snowflakes, we can create countless combinations of large illuminations.

Duże dekoracje świetlne zbudowane z prostych ozdób to kompozycje idealne na wysokie słupy latarniowe. Ich wysokość dochodząca do 3 m sprawia, że są widoczne z dużej odległości. Dzięki szerokiej gamie elementów z działów np. gwiazdy i śnieżynki możemy tworzyć nieskończoną ilość gotowych, dużych dekoracji świetlnych.

AVAILABLE LED COLOURS / DOSTĘPNE KOLORY LED

cold white, neutral white, warm white, classic white, yellow, orange, pink, purple, red, blue, water blue, green, multicolor, RGB

biały zimny, biały neutralny, biały ciepły, biały klasyczny, żółty, pomarańczowy, różowy, fioletowy, czerwony, niebieski, niebieski morski, zielony, multikolor, RGB



POLE MOUNTED DECOR / DEKORACJE LATARNIOWE
WEDGES / ROŻKI

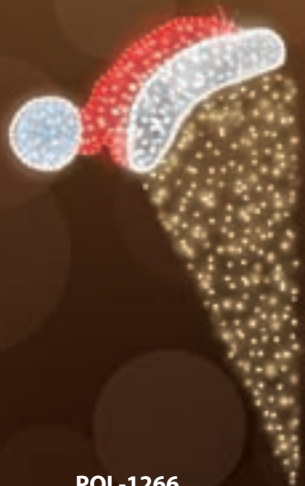

POL-1266
220x130 cm
LED35W



POL-1267
200x110 cm
LED35W



POL-1268
200x110 cm
LED35W

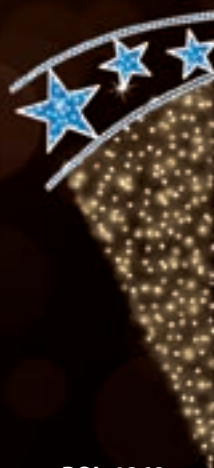

POL-1269
200x100 cm
LED33W



POL-1270
250x120 cm
LED32W



POL-0211
200x100 cm
LED30W



POL-0216
200x100 cm
LED29W



POL-1202
200x100 cm
LED27W



POL-0215
200x100 cm
LED24W

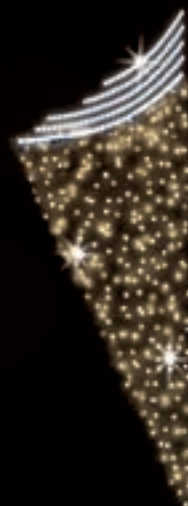

POL-0210
200x100 cm
LED32W



POL-0205
200x100 cm
LED30W



POL-0206
200x100 cm
LED28W



POL-0207
200x100 cm
LED26W



POL-1207
200x100 cm
LED25W



POL-0212
200x100 cm
LED30W



POL-1271
250x100 cm
LED58W



POL-1272
250x100 cm
LED65W



POL-1273
250x100 cm
LED65W



POL-1274
250x100 cm
LED55W



POL-1203
250x100 cm
LED67W



POL-1204
250x100 cm
LED48W



POL-1205
250x100 cm
LED66W



POL-1206
250x100 cm
LED53W

AVAILABLE LED COLOURS / DOSTĘPNE KOLORY LED

cold white, neutral white, warm white, classic white, yellow, orange, pink, purple, red, blue, water blue, green, multicolor, RGB

biały zimny, biały neutralny, biały ciepły, biały klasyczny, żółty, pomarańczowy, różowy, fioletowy, czerwony, niebieski, niebieski morski, zielony, multikolor, RGB



POLE MOUNTED DECOR / DEKORACJE LATARNIOWE
 CORNERS, SIGNAGE, MEDALLIONS WITH RIBBON / NAROŻNIKI, INNE



POL-0200
 120x100 cm
 LED29W



POL-0201
 120x100 cm
 LED29W



POL-0202
 120x100 cm
 LED28W



POL-0203
 100x100 cm
 LED32W



POL-0204
 100x100 cm
 LED35W



POL-1210
 200x100 cm
 LED30W



POL-1211
 200x100 cm
 LED30W



POL-1212
 155x85 cm
 LED40W



POL-1213
 250x120 cm
 LED75W



POL-1214
 155x85 cm
 LED30W

POL-1219
 300x100 cm
 LED90W

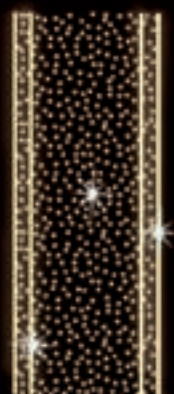

POL-1250
 170x100 cm
 LED52W



POL-1251
 200x100 cm
 LED43W

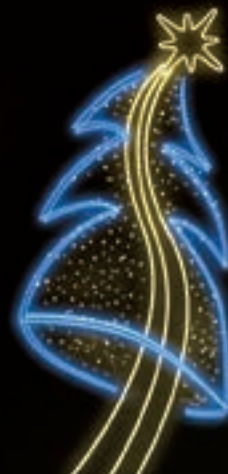

POL-1252
 300x100 cm
 LED115W



Ribbons may be enhanced with a pattern of star, snowflake, rosette or bauble ornaments.
 Jako uzupełnienie szarfy proponujemy dekoracje z sekcji gwiazdy, śnieżynki, rozety i bombki.



POL-0258
 225x75 cm
 LED55W



POL-0259
 225x75 cm
 LED55W



POL-0260
 225x75 cm
 LED55W

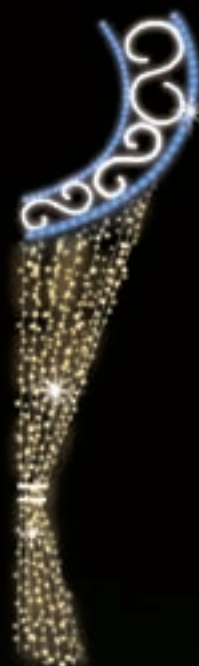

POL-1208
 225x75 cm
 LED55W



POL-1209
 225x75 cm
 LED55W



AVAILABLE LED COLOURS / DOSTĘPNE KOLORY LED
 cold white, neutral white, warm white, classic white, yellow, orange, pink, purple,
 red, blue, water blue, green, multicolor, RGB

biały zimny, biały neutralny, biały ciepły, biały klasyczny, żółty, pomarańczowy, różowy,
 fioletowy, czerwony, niebieski, niebieski morski, zielony, multikolor, RGB



POLE MOUNTED DECOR / DEKORACJE LATARNIOWE

WITH PVC BAUBLES, RIBBONS, SNOWFLAKES / Z BOMBKAMI PCV, SERPENTYNY, ŚNIEŻYNKI



POL-1700
300 x 100 cm
LED85W



POL-1701
300 x 100 cm
LED85W



POL-1702
300 x 100 cm
LED85W



POL-1703
300 x 100 cm
LED85W



POL-1760
190x100 cm
LED49W



INDIVIDUAL BAUBLES / BOMBKI POJEDYNCZE

white, silver, gold, red, blue, diameter from 100 to 300 mm
białe, srebrne, złote, czerwone, niebieskie od 100 do 300 mm

PVC baubles add depth to flat light decorations. Their highly lustrous surface reflects LED light, increasing decoration's luminosity. Use them to liven up any decoration and highlight its colours.

Bombki PCV dodają płaskim ozdobom przestrzeni. Dzięki wysokiemu połyskowi znakomicie odbijają światło lampek LED przez co potęgują moc światła. Dzięki nim ozdoby wyglądają na żywsze i bardziej kolorowe.



POL-1706
170x85cm
LED28W



POL-1707
100x100 cm
LED39W



POL-1704
225x80 cm
LED80W



POL-1761
225x80 cm
LED94W



POL-1762
225x80 cm
LED80W



POL-1763
225x80 cm
LED80W



POL-1764
225x80 cm
LED80W

POLE MOUNTED DECOR / DEKORACJE LATARNIOWE WITH PVC BAUBLES, RIBBONS, SNOWFLAKES Z BOMBKAMI PCV, SERPENTYNY, ŚNIEŻYNKI

AVAILABLE LED COLOURS / DOSTĘPNE KOLORY LED

cold white, neutral white, warm white, classic white, yellow, orange, pink, purple, red, blue, water blue, green, multicolor, RGB

biały zimny, biały neutralny, biały ciepły, biały klasyczny, żółty, pomarańczowy, różowy, fioletowy, czerwony, niebieski, niebieski morski, zielony, multikolor, RGB

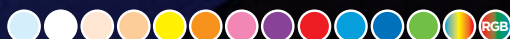

POLE MOUNTED DECOR / DEKORACJE LATARNIOWE

STARS, RIBBONS, SNOWFLAKES / GWIAZDY, SERPENTYNY, ŚNIEŻYNKI



Suggested street light decoration mounting placement. Decorations can be mounted in a variety of ways depending on the pole height and light cover shape and type. The possibilities are nearly endless.

Przykład obok pokazuje sposób w jaki można ozdobić daną latarnię. W zależności od kształtu klosza, sposobu jego mocowania na słupie i wysokości lampy ulicznej możemy stosować niemal nieskończoną ilość rozwiązań.

POL-0124

190x100 cm
411W/LED80W



POL-0126

150x100 cm
150W/LED30W

POL-0121

200x100 cm
245W/LED51W

POL-0125

225x125 cm
311W/LED65W

POL-0128

150x100 cm
130W/LED28W

POL-0123

200x100 cm
265W/LED54W

POL-0129

120x100 cm
87W/LED18W



POL-0127

200x100 cm
150W/LED31W

POL-0130

180x80 cm
130W/LED28W

POL-0122

200x100 cm
369W/LED75W

POL-0224

200x100 cm
235W/LED47W

POL-0228

150x100 cm
120W/LED24W

POL-0220

150x80 cm
258W/LED53W

POL-0220M

150x80 cm
258W/LED53W



POL-0223

200x100 cm
245W/LED50W

POL-0222

175/80 cm
239W/LED48W

POL-0219

150x80 cm
240W/LED49W

POL-0221

195/80 cm
250W/LED50W

POL-0218

155x80 cm
330W/LED66W

POL-0217

170/80 cm
239W/LED49W

POL-0238

280x130 cm
462W/LED92W

POL-0243
300x130 cm
765W/LED150W



POL-0227
110x90 cm
138W/LED28W



POL-0226
110x90 cm
138W/LED28W



POL-0244
200x100 cm
LED94W



POL-1200
200x110 cm
244W/LED48W



POL-0234
150x80 cm
169W/LED32W



POL-0263M
200x100 cm
LED65W



POL-0264M
200x40 cm
LED54W

POL-0265M
250x80 cm
LED66W



POL-0236
150x100 cm
120W/LED23W



POL-0237
200x100 cm
250W/LED52W



POL-0237M
200x100 cm
LED78W



POL-0240
250x130 cm
LED50W



POL-0241
250x130 cm
260W/LED53W



POL-0262M
200x110 cm
LED70W



POL-0242
320x120 cm
380W/LED75W



POL-1201
320x120 cm
380W/LED75W

AVAILABLE LED COLOURS / DOSTĘPNE KOLORY LED
cold white, neutral white, warm white, classic white, yellow, orange, pink, purple,
red, blue, water blue, green, multicolor, RGB
biały zimny, biały neutralny, biały ciepły, biały klasyczny, żółty, pomarańczowy, różowy,
fioletowy, czerwony, niebieski, niebieski morski, zielony, multikolor, RGB



POLE MOUNTED DECOR / DEKORACJE LATARNIOWE
WITHOUT ROPE LIGHT / BEZ WĘŻA



POL-0628
150x150 cm
LED58W



POL-0627
200x150 cm
LED210W



POL-0626
200x120 cm
LED180W



POL-0600
100x100 cm
LED17W



POL-0601
200x90 cm
LED18W



POL-0602
200x80 cm
LED17W



POL-0603
200x110 cm
LED14W



POL-0604
160x80 cm
LED23W



POL-0605
160x70 cm
LED19W

POL-0606
280x90 cm
LED34W





AVAILABLE LED COLOURS / DOSTĘPNE KOLORY LED

cold white, neutral white, warm white, classic white, yellow, orange, pink, purple, red, blue, water blue, green, multicolor, RGB

biały zimny, biały neutralny, biały ciepły, biały klasyczny, żółty, pomarańczowy, różowy, fioletowy, czerwony, niebieski, niebieski morski, zielony, multikolor, RGB



POL-0555
Ø 150 cm
LED23W



POL-0556
Ø 120 cm
LED18W



POL-0557
Ø 100 cm
LED15W



POL-0558
Ø 80 cm
LED12W

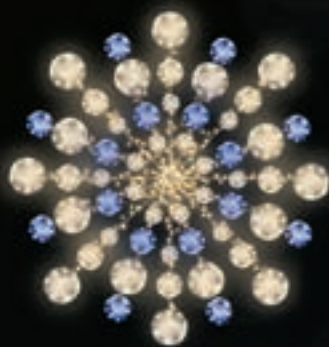

POL-0559
Ø 150 cm
LED18W

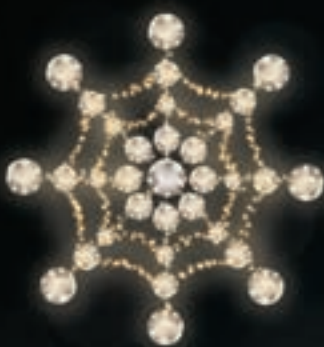

POL-0560
Ø 120 cm
LED18W

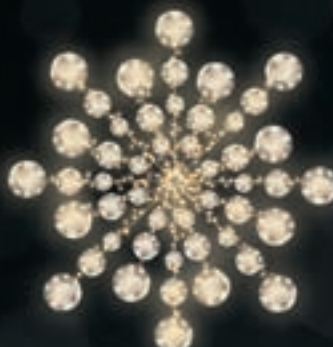

POL-0561
Ø 120 cm
LED18W

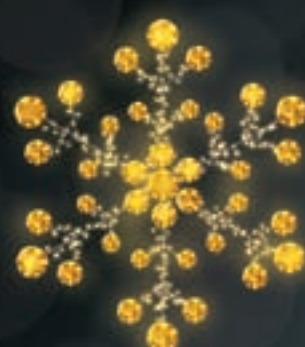

POL-0562
Ø 120 cm
LED18W

POLE MOUNTED DECOR / DEKORACJE LATARNIOWE

SYMMETRICAL / SYMETRYCZNE



POL-0526
100x100 cm
126W/LED25W



POL-0527
115x130 cm
293W/LED60W



POL-0530
115x130 cm
300W/LED60W



POL-0529
110x110 cm
300W/LED60W



POL-0528
120x80 cm
124W/LED25W



POL-0522
200x110 cm
148W/LED30W

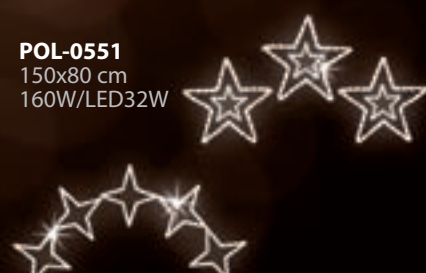

POL-0551
150x80 cm
160W/LED32W

POL-0550
75x155 cm
265W/LED55W



POL-0525
100x120 cm
125W/LED25W



POL-0245
100x125 cm
LED25W



POL-0246
200x125 cm
LED52W



POL-0247
200x130 cm
LED52W

These symmetrical ornaments or symmetrical composition of two identical decorations wonderfully adorn street lights in parks and historical districts.

Dekoracje symetryczne lub składające się z dwóch takich samych ornamentów umieszczonych symetrycznie wokół kloszy latarniowych. Idealne do latarni parkowych i staro-miejskich.

AVAILABLE LED COLOURS / DOSTĘPNE KOLORY LED

cold white, neutral white, warm white, classic white, yellow, orange, pink, purple, red, blue, water blue, green, multicolor, RGB

biały zimny, biały neutralny, biały ciepły, biały klasyczny, żółty, pomarańczowy, różowy, fioletowy, czerwony, niebieski, niebieski morski, zielony, multikolor, RGB





POL-0193
140x100 cm
LED35W



POL-0192
130x90 cm
LED26W



POL-1111
130x130 cm
LED38W



POL-1112
120x170 cm
125W/LED29W



POL-1113
100x100 cm
119W/LED24W



POL-1114
120x100 cm
119W/LED24W



POL-0187
130x110 cm
141W/LED30W



POL-0194
100x90 cm
119LED24W



POL-0195
100x90 cm
LED33W



POL-1402
250x400 cm
800W/LED160W



POL-1403
250x400 cm
800W/LED160W

AVAILABLE LED COLOURS / DOSTĘPNE KOLORY LED

cold white, neutral white, warm white, classic white, yellow, orange, pink, purple, red, blue, water blue, green, multicolor, RGB

biały zimny, biały neutralny, biały ciepły, biały klasyczny, żółty, pomarańczowy, różowy, fioletowy, czerwony, niebieski, niebieski morski, zielony, multikolor, RGB



ALL-PURPOSE DECORATIONS / UNIWERSALNE
VARIOUS / RÓZNE



POL-0072
200x200 cm
LED65W



POL-0073
200x170 cm
LED62W



POL-0074
150x170 cm
LED25W



POL-0075
150x170 cm
LED40W



POL-0076
150x150 cm
LED27W



POL-0077
150x150 cm
LED40W



POL-0078
150x150 cm
LED50W



POL-0079
165x165 cm
LED50W



POL-0080
175x130 cm
LED40W



POL-0081
175x175 cm
LED70W



POL-0100
135x100 cm
LED35W



POL-0101
150x120 cm
LED58W



POL-0102
175x120 cm
LED55W

POL-0103
200x200 cm
LED80W



POL-0104
250x170 cm
LED85W



AVAILABLE LED COLOURS / DOSTĘPNE KOLORY LED

cold white, neutral white, warm white, classic white, yellow, orange, pink, purple,
red, blue, water blue, green, multicolor, RGB

biały zimny, biały neutralny, biały ciepły, biały klasyczny, żółty, pomarańczowy, różowy,
fioletowy, czerwony, niebieski, niebieski morski, zielony, multikolor, RGB



ALL-PURPOSE DECORATIONS / UNIWERSALNE

VARIOUS / RÓŻNE

Timeless, classic designs. Low-cost and versatile. Perfect for facades, interiors (i.e. as store decor) and pole mounted decorations alike. Look no further if you need a standard, classic design in short order.

Sprawdzone, proste wzory. Ich zaletą jest uniwersalność i niska cena. Nadają się zarówno do zdobienia zewnętrznych elewacji jak i wnętrz budynków. Mogą występować jako dekoracje latarniowe ale też jako np. wystrój sklepu. Polecane są tam gdzie szybko potrzebujemy sprawdzonego wzoru.



POL-0188
70x50 cm
58W/LED13W



POL-0189
Ø 50 cm
45W/LED9W



POL-0140
150x100 cm
200W/LED42W



POL-0171
180x150 cm
448W/LED90W



POL-0110
140x110 cm
80W/LED17W



POL-0118
120x110 cm
80W/LED16W



POL-1104
Ø 100 cm
118W/LED23W



POL-0116
120x90 cm
138W/LED28W



POL-0113
130x90 cm
131W/LED27W



POL-0120
120x70 cm
91W/LED18W



POL-0109
75x55 cm
104W/LED22W



POL-0532
100x120
125W/LED25W



POL-1103
100x120
LED29W



POL-0115
140x100 cm
95W/LED24W



POL-0131
150x130 cm
135W/LED29W



POL-0107
190x80 cm
215W/LED43W



POL-0106
120x70 cm
65W/LED14W

PRESENTS



POL-1106
150x130 cm, LED63W



POL-1105
150x130 cm, LED63W



POL-1108
150x130 cm, LED52W



POL-1109
150x130 cm, LED58W

POL-1110
280x150 cm, LED64W



POL-1107
150x130 cm
LED58W



POL-0198
190x180 cm
LED95W





POL-0141
160x90 cm
198W/LED39W



POL-0135
150x100 cm
178W/LED35W



POL-0134
150x100 cm
138W/LED30W



POL-0155
120x80 cm
151W/LED31W



POL-0111
120x90 cm
135W/LED27W



POL-0196
100x100 cm
184W/LED30W



POL-0119
100x120 cm
142W/LED32W



POL-0112
140x120 cm
156W/LED33W



POL-1118
100x60 cm
100W/LED21W



POL-0191
110x90 cm
98W/LED24W



POL-0190
100x110 cm
112W/LED23W



POL-1116
150x120 cm
140W/LED28W



POL-1117
200x100 cm
130W/LED26W



POL-1115
150x150 cm
LED46W

AVAILABLE LED COLOURS / DOSTĘPNE KOLORY LED
cold white, neutral white, warm white, classic white, yellow, orange, pink, purple, red, blue, water blue, green, multicolor, RGB

biały zimny, biały neutralny, biały ciepły, biały klasyczny, żółty, pomarańczowy, różowy, fioletowy, czerwony, niebieski, niebieski morski, zielony, multikolor, RGB



ALL-PURPOSE DECORATIONS / UNIWERSALNE

XMAS TREES, SNOWMEN / CHOINKI I BAŁWANY



POL-0178
200x120 cm
LED40W



POL-0142
110x90 cm
99W/LED23W



POL-0143
110x200 cm
225W/LED45W



POL-0144
220x150 cm
249W/LED52W



POL-0185
115x85 cm
LED20W



POL-0184
180x120 cm
LED60W



POL-0146
110x200 cm
244W/LED50W



POL-0183
140x100 cm
209W/LED41W



POL-0153
145x85 cm
226W/LED46W



POL-0145
150x100 cm
199W/LED39W



POL-0152
120x70 cm
111W/LED24W



POL-0149
120x70 cm
112W/LED24W



POL-0147
200x120 cm
175W/LED35W



POL-0148
140x80 cm
134W/LED29W



POL-0154
120x80 cm
111W/LED26W



POL-0172
120x100 cm
98W/LED24W



POL-0173
120x100 cm
98W/LED24W



POL-0174
120x100 cm
100W/LED25W



POL-0150
300x100 cm
LED70W



POL-0151
300x120 cm
LED84W



POL-0175
120x100 cm
98W/LED24W



POL-0176
120x100 cm
98W/LED24W



POL-0177
120x100 cm
100W/LED25W

POL-0405
200x600 cm
1250W/LED250W

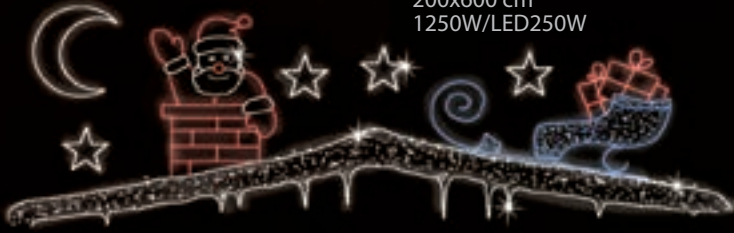

POL-1401
150x300 cm
LED128W

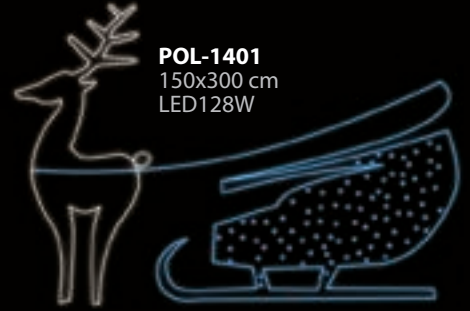

POL-1400
150x500 cm
640W/LED128W



POL-1312
150x500 cm, LED168W



Compound light ornaments are used in over-the-street or facade decor. They're often chosen for their diverse structure and large size.

Dekoracje złożone mogą funkcjonować jako przewieszki lub jako ozdoby elewacyjne. Charakteryzują się bogactwem elementów i rozmiarami.

AVAILABLE LED COLOURS / DOSTĘPNE KOLORY LED
cold white, neutral white, warm white, classic white, yellow, orange, pink, purple, red, blue, water blue, green, multicolor, RGB
biały zimny, biały neutralny, biały ciepły, biały klasyczny, żółty, pomarańczowy, różowy, fioletowy, czerwony, niebieski, niebieski morski, zielony, multicolor, RGB



ALL-PURPOSE DECORATIONS / UNIWERSALNE
 COMPOUND DECOR, COMPOUND DECOR WITH MAT
 ZŁOŻONE, ZŁOŻONE NA MATACH



POL-0400
 180x200 cm
 250W/LED52W



POL-0401
 180x220 cm
 390W/LED81W



POL-0400M
 180x200 cm
 LED80W



POL-0401M
 180x220 cm
 LED120W



POL-0403
 140x300 cm
 900W/LED181W



POL-0403M
 140x300 cm
 LED242W

Nearly all of our decorations may be enhanced with the addition of a mat. Colourful mats refract light and increase the luminosity and colour depth of decorations. Motifs listed on this page are merely suggestions.

Kolorowe maty odbijając światło potęgują jasność dekoracji i mocniej podkreślają kolor. Prezentowane wzory to tylko przykład użycia różnokolorowych mat na standardowych ozdobach. W praktyce każda nasza dekoracja świetlna może być wzbogacona matą.



AVAILABLE LED COLOURS
 cool white, warm white, yellow, orange, pink, purple, red, blue,
 water blue, green, multicolor



Suggested combinations of popular motifs with mats. The mats refract light and increase the luminosity and colour depth of decorations. White LEDs with conjunction of a blue mat produce blue light.

Przykłady naszych popularnych wzorów na kolorowych matach. Kolorowe maty odbijając światło potęgują jasność dekoracji i mocniej podkreślają kolor. Używając np. niebieskiej maty możemy położyć na niej białe lampki by uzyskać złudzenie niebieskiego oświetlenia.

AVAILABLE LED COLOURS / DOSTĘPNE KOLORY LED

cold white, neutral white, warm white, classic white, yellow, orange, pink, purple, red, blue, water blue, green, multicolor, RGB

biały zimny, biały neutralny, biały ciepły, biały klasyczny, żółty, pomarańczowy, różowy, fioletowy, czerwony, niebieski, niebieski morski, zielony, multikolor, RGB



POL-0193M
140x100 cm
LED35W

POL-0191M
110x90 cm
LED29W

POL-0186
115x85 cm
LED20W



POL-0189M
50x50 cm
LED15W

POL-0111M
120x90 cm
LED42W

POL-0188M
70x50 cm
LED27W



POL-0055M
Ø 80 cm
LED43W

POL-0199M
Ø 80 cm
LED45W

POL-0532M
100x120 cm
LED40W

POL-0115M
140x100 cm
LED44W

POL-0107M
190x80 cm
LED47W

POL-0186M
60x30 cm
LED23W

POL-0167M
200x130 cm
LED65W

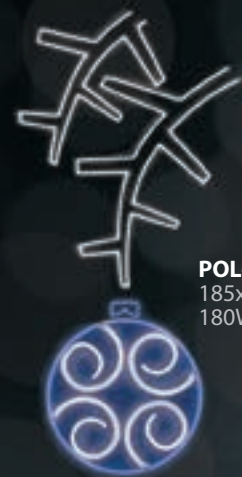

POL-1102M
185x95 cm
180W/LED35W

ALL-PURPOSE DECORATIONS / UNIWERSALNE MEDALLIONS / MEDALIONY



POL-0060
Ø 100 cm / Ø 150 cm
230W / LED45W
300W / LED68W



POL-0061
Ø 100 cm / Ø 150 cm
230W / LED45W
300W / LED68W



POL-0062
Ø 100 cm / Ø 150 cm
230W / LED45W
300W / LED68W



POL-0063
Ø 100 cm / Ø 150 cm
245W / LED49W
337W / LED76W



POL-0064
Ø 100 cm / Ø 150 cm
LED49W / LED74W



POL-0065
Ø 100 cm / Ø 150 cm
LED49W / LED74W



POL-0066
Ø 100 cm / Ø 150 cm
LED49W / LED74W



POL-0067
Ø 100 cm / Ø 150 cm
LED49W / LED74W



POL-0045
Ø 100 cm / Ø 150 cm
LED50W / LED75W



POL-0046
Ø 100 cm / Ø 150 cm
LED65W / LED90W



POL-0047
Ø 100 cm / Ø 150 cm
LED50W / LED75W



POL-0048
Ø 100 cm / Ø 150 cm
LED50W / LED75W



POL-0049
Ø 100 cm / Ø 150 cm
LED50W / LED75W



POL-0050
Ø 100 cm / Ø 150 cm
LED48W / LED72W



POL-0058
Ø 100 cm / Ø 150 cm
LED55W / LED80W



POL-0059
Ø 100 cm / Ø 150 cm
LED48W / LED72W



POL-0068
Ø 100 cm / Ø 150 cm
LED50W / LED75W



POL-0069
Ø 100 cm / Ø 150 cm
LED50W / LED75W

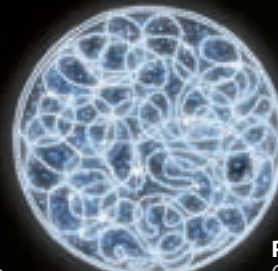

POL-0071
Ø 100 cm / Ø 150 cm
LED60W / LED85W



POL-1500
200x220 cm
LED75W



POL-1501
200x220 cm
LED72W



POL-1502
200x220 cm
LED80W



POL-1503
200x220 cm
LED81W



POL-1504
200x220 cm
LED85W

AVAILABLE LED COLOURS / DOSTĘPNE KOLORY LED

cold white, neutral white, warm white, classic white, yellow, orange, pink, purple, red, blue, water blue, green, multicolor, RGB

biały zimny, biały neutralny, biały ciepły, biały klasyczny, żółty, pomarańczowy, różowy, fioletowy, czerwony, niebieski, niebieski morski, zielony, multicolor, RGB



ALL-PURPOSE DECORATIONS / UNIWERSALNE

CHRISTMAS BALLS / БОМБКИ



POL-0051
Ø 120 cm
245W/LED49W



POL-0083
Ø 120 cm
300W/LED60W



POL-0084
Ø 120 cm
LED52W



POL-0085
Ø 120 cm
LED52W



POL-0052
Ø 120 cm
300W/LED60W



POL-0051B
Ø 120 cm
245W/LED49W



POL-0085B
Ø 120 cm
LED52W



POL-0084B
Ø 120 cm
LED52W



Baubles are the second most popular choice after stars & snowflakes. Next to versatility, their chief asset is their vivid colour which lightens up cold winter evenings.

Najpopularniejsze i najchętniej obok gwiazd i śnieżynek wybierane ozdoby. Ich zastosowanie jest bardzo szerokie, od elewacji budynków po latarnie. Ich mocną stroną są intensywne kolorowe barwy, dzięki którym bardzo ożywiają ciemne zimowe wieczory.

AVAILABLE LED COLOURS / DOSTĘPNE KOLORY LED

cold white, neutral white, warm white, classic white, yellow, orange, pink, purple, red, blue, water blue, green, multicolor, RGB
biały zimny, biały neutralny, biały ciepły, biały klasyczny, żółty, pomarańczowy, różowy, fioletowy, czerwony, niebieski, niebieski morski, zielony, multicolor, RGB





POL-0054
Ø 100 cm
200W/LED40W



POL-0055
Ø 100 cm
200W/LED40W



POL-0056
Ø 100 cm
200W/LED40W



POL-0057
Ø 100 cm
200W/LED40W



POL-0086
Ø 120 cm
245W/LED49W



POL-0082
Ø 120 cm
220W/LED44W



POL-0552
120x100 cm
425W/LED85W



POL-0053
140x100 cm
305W/LED60W



POL-0170
150x100 cm
389W/LED77W



POL-0114
190x150 cm
433W/LED85W



POL-1100
185x95cm
180W/LED35W



POL-1101
185x95cm
180W/LED35W



POL-1102
185x95cm
180W/LED35W



POL-0197
200x120 cm
LED120W



POL-0553
145x145
375W/LED75W



POL-0136
150x120 cm
200W/LED42W



POL-0138
150x120 cm
165W/LED33W



POL-0139
185x95 cm
180W/LED35W

ALL-PURPOSE DECORATIONS / UNIWERSALNE
SNOWFLAKES / ŚNIEŻYNKI



POL-0039
Ø 150 cm
LED180W



POL-0040
Ø 150 cm
LED175W



POL-0041
Ø 150 cm
LED190W



POL-0042
Ø 150 cm
LED150W



POL-0043
Ø 150 cm
LED150W



POL-0044
Ø 150 cm
LED160W



POL-0027
Ø 150 cm
372W/LED73W



POL-0014
Ø 100 cm
185W/LED38W



POL-0015
Ø 65 cm
86W/LED18W



POL-0028
Ø 100 cm
320W/LED63W



POL-0029
Ø 120 cm
380W/LED76W

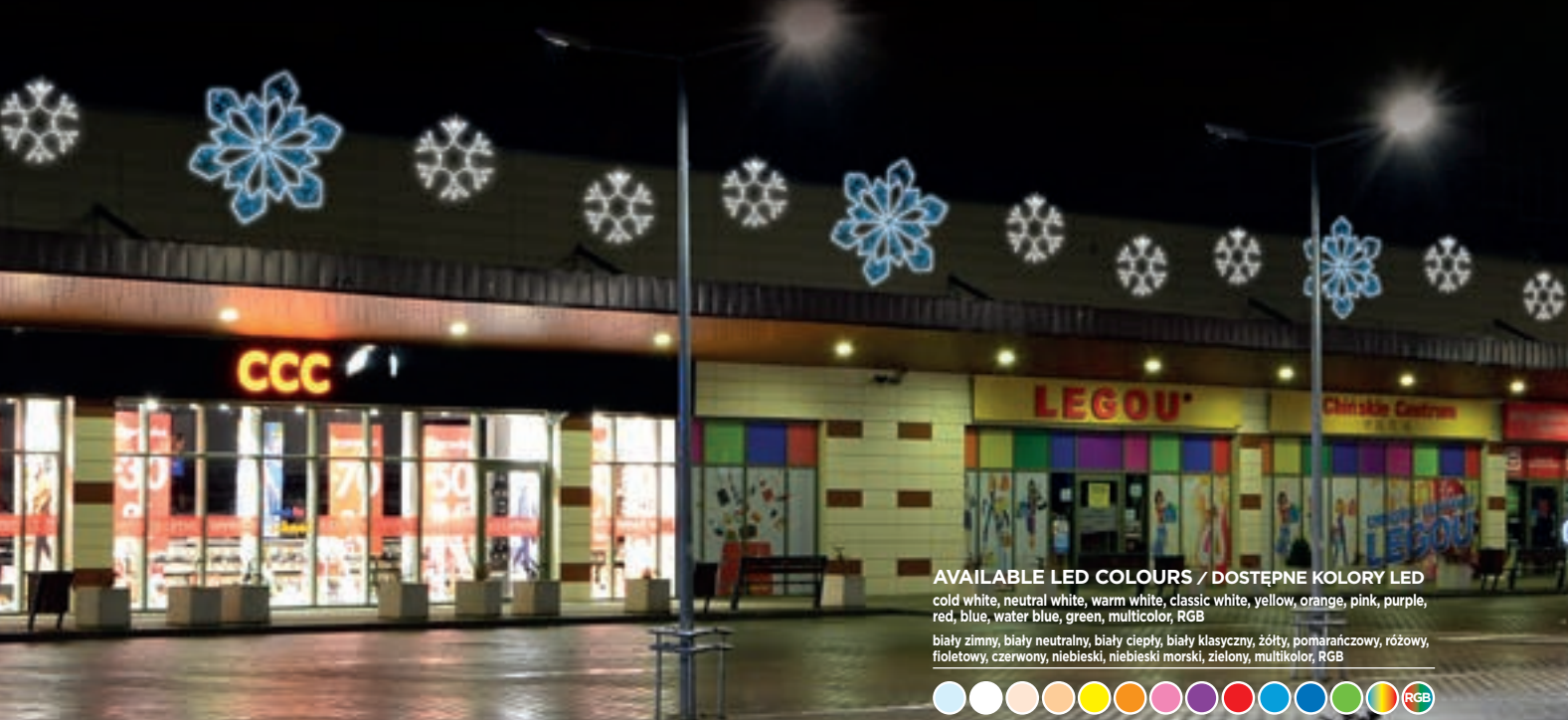

AVAILABLE LED COLOURS / DOSTĘPNE KOLORY LED
cold white, neutral white, warm white, classic white, yellow, orange, pink, purple,
red, blue, water blue, green, multicolor, RGB

biały zimny, biały neutralny, biały ciepły, biały klasyczny, żółty, pomarańczowy, różowy,
fioletowy, czerwony, niebieski, niebieski morski, zielony, multikolor, RGB





POL-0035
Ø 150 cm / Ø 300 cm
278W/LED56W
/ 1079W/LED211W



POL-0023
Ø 150 cm / Ø 300 cm
276W/LED55W
/ 1071W/LED210W



POL-0032
Ø 150 cm / Ø 300 cm
278W/LED56W
/ 1079W/LED211W



POL-0099
Ø 150 cm / Ø 300 cm
278W/LED56W
/ 1079W/LED211W



POL-0098
Ø 150 cm / Ø 200 cm
278W/LED56W
400W/LED75W



POL-0097
Ø 100 cm / Ø 200 cm
130W/LED29W
/ 250W/LED48W



POL-0036
Ø 100 cm
185W/LED38W



POL-0024
Ø 120 cm
263W/LED53W



POL-0025
Ø 100 cm
190W/LED40W



POL-0026
Ø 120 cm / Ø 300 cm
364W/LED60W
878W/LED172W



POL-0010
Ø 65 cm
86W/LED19W



POL-0009
Ø 100 cm
174W/LED34W



POL-0096
Ø 50 cm / Ø 75 cm
75W/LED15W
/ 110W/LED22W



POL-0012
Ø 45 cm
79W/LED16W



POL-0013
Ø 45 cm / Ø 75 cm
75W/LED15W
/ 110W/LED22W



POL-0001
Ø 50 cm / Ø 75 cm
33W/LED7W
/ 49W/LED10W



POL-0002
Ø 50 cm / Ø 100 cm
31W/LED6W
/ 70W/LED14W

All-purpose decorations are designed for street lights, facades and interior decor. Individual pieces can be combined into larger motifs, i.e. over-the-street or large facade decorations. Snowflakes and similar smaller all-purpose motifs are available with or without the frame. The latter variant is better suited for hanging from Christmas trees.

Gwiazdy i śnieżynki jako dekoracje uniwersalne mogą być stosowane zarówno na latarniach jak i na elewacjach. Dobrze wyglądają też jako pojedyncze ozdoby w wystroju wnętrz. Możemy je także łączyć tworząc rozległe kompozycje np. jako przewieszki nad ulicami lub ozdoby na dużych elewacjach biurowców czy galerii handlowych. Mogą być wykonane na stelażu lub bez np. do powieszenia na choinkach.



POL-0003
Ø 50 cm / Ø 75 cm
30W/LED6W
/ 49W/LED10W



POL-0004
Ø 65 cm
30W/LED6W



POL-0005
Ø 50 cm
32W/LED7W



POL-0006
Ø 50 cm
38W/LED8W



POL-0007
Ø 50 cm / Ø 75 cm
45W/LED9W
/ 71W/LED14W



POL-0008
Ø 75 cm
111W/LED22W



POL-0020
Ø 75 cm / Ø 100 cm
70W/LED14W
/ 98W/LED20W



POL-0021
Ø 100 cm / Ø 150 cm
115W/LED23W
190W/LED38W



POL-0011
Ø 65 cm
86W/LED18W



POL-0022
Ø 100 cm
135W/LED27W



POL-0034
100x65 cm
96W/LED15W



POL-0033
Ø 75 cm / Ø 100 cm
75W/LED14W / 98W/LED20W

ALL-PURPOSE DECORATIONS / UNIWERSALNE
SNOWFLAKES WITH MATS & BAUBLES / ŚNIEŻYNKI I GWIAZDY Z MATAMI I BOMBKAMI



POL-0009M
Ø 100 cm
LED40W



POL-0025M
Ø 100 cm
LED44W



POL-0023M
Ø 150 cm / Ø 300 cm
LED60W / LED219W

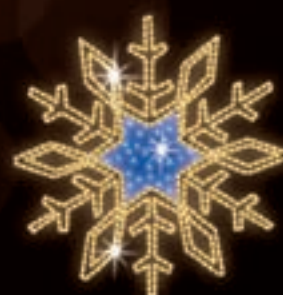

POL-0026M
Ø 120 cm / Ø 300 cm
LED63W / LED175W



POL-0095M
Ø 120 cm
LED77W



POL-0099M
Ø 150 cm / Ø 300 cm
LED59W / LED215W



POL-0099B
Ø 150 cm / Ø 300 cm
278W/LED56W
/ 1079W/LED211W



POL-0023B
Ø 150 cm / Ø 300 cm
276W/LED55W / 1079W/LED210W



POL-0009B
Ø 100 cm
174W/LED34W



POL-0026B
Ø 120 cm / Ø 300 cm
364W/LED60W / 878W/LED172W



POL-0098B
Ø 150 cm / Ø 200 cm
278W/LED56W / 400W/LED75W



POL-0092B-2
Ø 100 cm
LED28W



POL-0092B-1
Ø 100 cm
LED28W



POL-0093MB-1
Ø 100 cm
LED49W



POL-0093MB-2
Ø 100 cm
LED49W



POL-0043B
Ø 150 cm
LED150W

Nearly all our decorations may be enhanced with the addition of a mat. Colourful mats refract light and increase the luminosity and colour depth of light ornaments. Motifs listed on this page are merely suggestions. Many of our suggestions come with PVC ornaments. If you wish, we may embellish any design with such addition. Ornaments are available in following colours: gold, red, blue, silver or white. Additional colours available upon request.

Praktycznie każda nasza dekoracja świetlna może być wzbogacona matą. Kolorowe maty odbijając światło potęgują jasność dekoracji i mocniej podkreślają kolor. Prezentowane wzory to tylko przykład użycia różnokolorowych mat na standardowych ozdobach.



POL-0093
Ø 100 cm
220W/LED46W



POL-0092
Ø 100 cm
140W/LED28W



POL-0091
Ø 100 cm
140W/LED28W



POL-0090
Ø 100 cm
400W/LED81W



POL-0089
Ø 100 cm
445W/LED89W



POL-0088
Ø 100 cm
180W/LED38W



POL-0087
Ø 100 cm
LED52W



POL-0093M
Ø 100 cm
LED49W



POL-0092M
Ø 100 cm
LED32W

Rosettes are a new addition in our product family. While stars and snowflakes are regarded as typically festive, rosettes may be freely displayed all year round. They look wonderful on circular windows and openings in church facades. They may also be combined into larger motifs (i.e. over-the-street decorations).

Rozety to nowość w naszej ofercie. W odróżnieniu od gwiazdek i śnieżynek o charakterze świątecznym mogą być eksponowane przez cały rok. Idealnie nadają się do zdobienia owalnych okien i okrągłych otworów w elewacjach kościołów oraz do komponowania większych dekoracji (np. przewieszki uliczne).



AVAILABLE LED COLOURS / DOSTĘPNE KOLORY LED
cold white, neutral white, warm white, classic white, yellow, orange, pink, purple, red, blue, water blue, green, multicolor, RGB

biały zimny, biały neutralny, biały ciepły, biały klasyczny, żółty, pomarańczowy, różowy, fioletowy, czerwony, niebieski, niebieski morski, zielony, multikolor, RGB



ALL-PURPOSE DECORATIONS / UNIWERSALNE BOWS & RIBBONS WITH MAT / KOKARDY I WSTĄŻKI NA MATACH



POL-0162M
200x200x8 cm
LED200W



POL-0163M
200x200x20 cm
LED328W



POL-0156
150x150x20 cm
LED200W



POL-0164M
60x200x5 cm
LED46W



POL-0165M
60x200x5 cm
LED46W



POL-0166M
60x200x5 cm
LED90W

Colourful mats refract light and increase the luminosity and colour depth of decorations. Motifs listed on this page are merely suggestions. Nearly all of our decorations may be enhanced with the addition of a mat. However, mats also increase decoration's air resistance, therefore they're not suited for large pole mounted decor, etc. They're safest on facades or as smaller pole mounted decorations.

Kolorowe maty odbijając światło potęgują jasność dekoracji i mocniej podkreślają kolor. Prezentowane wzory to tylko przykład użycia różnokolorowych mat na standardowych ozdobach. Praktycznie każda nasza dekoracja świetlna może być wzbogacona matą. Należy jedynie pamiętać o oporze jaki taka dekoracja może stawić przy silnym wietrze, dlatego polecamy je szczególnie na elewacje lub mniejsze wzory na latarniach.

AVAILABLE LED COLOURS / DOSTĘPNE KOLORY LED

cold white, neutral white, warm white, classic white, yellow, orange, pink, purple, red, blue, water blue, green, multicolor, RGB

biały zimny, biały neutralny, biały ciepły, biały klasyczny, żółty, pomarańczowy, różowy, fioletowy, czerwony, niebieski, niebieski morski, zielony, multikolor, RGB



POL-0266
 120x75cm
 LED15W



POL-0267
 75x60 cm
 LED12W



POL-0268
 90x60cm
 LED19W



POL-0269
 150x100 cm
 LED15W



POL-0270
 300x140 cm
 LED32W



POL-0271
 300x150 cm
 LED32W



POL-0272
 300x150 cm
 LED33W



POL-0273
 300x150 cm
 LED33W



POL-0274
 120x180 cm
 LED35W



POL-0275
 100x150 cm
 LED32W

ATYPICAL DECORATIONS / DEKORACJE NIETYPOWE

FIGURES, TREES, STARS, LANTERNS / FIGURY, DRZEWKA, GWIAZDY, LAMPIONY



POL-1954
140x80x20 cm
300W/LED60W



POL-1955
200x120x20 cm
650W/LED130W



POL-1957
180x110x20 cm
700W/LED140W



POL-1956
120x180x20 cm, 680W/LED135W

3D figures composed of LED rope light are examples of a perfect combination of two identical planes into a block - as a result we get a three-dimensional effect in a simple manner. Unlike 3D figures composed of LED lights, LED rope lights are better for bringing out the outline of the block, making the shape more recognisable.

Figury 3D z węża to efektowne połączenie dwóch jednakowych płaszczyzn w jedną bryłę. Dzięki temu w prosty sposób uzyskujemy trójwymiarowy efekt. W odróżnieniu od figur 3D z lampek LED węża lepiej podkreślają kontur bryły dzięki temu kształt postaci jest bardziej rozpoznawalny.

A combination of a few traditional fluorescent or LED lamps in the form of a star. Fluorescent lamps, unlike LED rope lights, emit a stronger beam of light, which is also evenly distributed.

Połączenie w formie gwiazdy kilku świetlówek tradycyjnych lub LED. Świetłówka w odróżnieniu od węża emituje mocniejsze i równomiernie rozłożone światło.



POL-2000
140x160 / 320x300 / 400x350 cm
180W/LED90W
360W/LED180W
580W/LED290W



POL-2001
140x160 / 320x300 / 400x350 cm
- głębokość od 20 do 50 cm
540W/LED270W
1080W/LED540W
1740W/LED870W



POL-2004
Ø 225 cm, LED40W



POL-2005
Ø 125 cm, LED7W

In the case of meteor shower rain lights we can observe the falling light effect. Arranged in the form of a star, these lights animate the decoration w/ rhythmic, flowing light.

W przypadku meteorków możemy zaobserwować tzw. „efekt spadającego światła”. Ułożone w kształt gwiazdy sprawiają, że dekoracja ożywa pulsującym, przepływającym światłem.



POL-2003
60x15x15 / 120x20x20 cm
LED5W / LED10W





POL-2006
100x250cm
LED19W



POL-2007
120x100 x30 cm
LED14W



POL-2008
100x30 cm
LED10W

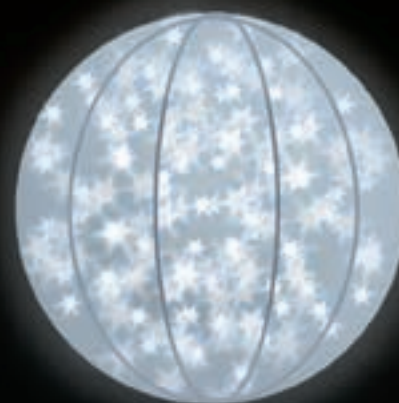

POL-2009
Ø 100 cm
LED14W

Optical PET film changes the light coming from the inside into sparkling stars.

Folia optyczna sprawia, że światło lampek LED wewnątrz dekoracji zamienia się w świecące gwiazdki.



ATYPICAL DECORATIONS / DEKORACJE NIETYPOWE

BAUBLES AND GIANT PVC STARS / BOMBKI I GWIAZDY PCV GIGANTY

Baubles and giant PVC stars are new in our offer. Decorations such as baubles up to 100 cm and stars up to 200 cm of height look perfect both in the daytime and the nighttime. We offer the following colours: white, silver, yellow, red, and blue.

Bombki i gwiazdy giganty z PCV to kolejna nowość w naszej ofercie. Bombki do 100 cm i gwiazdy do 200 cm to propozycja ozdób, które prezentują się równie dobrze w nocy jak i w dzień. Posiadamy kolory: biały, srebrny, żółty, czerwony i niebieski.



POL-GI-B50-W
50/60/70/80/
90/100 cm

POL-GI-B50-S
50/60/70/80/
90/100 cm

POL-GI-B50-G
50/60/70/80/
90/100 cm

POL-GI-B50-R
50/60/70/80/
90/100 cm

POL-GI-B50-B
50/60/70/80/
90/100 cm



POL-GI-G100-W
100/150/200 cm

POL-GI-G100-S
100/150/200 cm

POL-GI-G100-G
100/150/200 cm

POL-GI-G100-R
100/150/200 cm

POL-GI-G100-B
100/150/200 cm

Rozmiary bombek: 50, 60, 70, 80, 100 cm
Rozmiary gwiazd: 100, 150, 200 cm



POL-2050
50/60/70/80/
90/100 cm

Also available as illuminations combined with LED lights. Thanks to baubles' glistening surface, the LED light and the general effect are intensified.

Dostępne są również jako iluminacje świetlne w połączeniu z lampkami LED. Dzięki połyskliwej powierzchni bombki wzmocnione zostaje światło diod i ogólny efekt dekoracji.

AVAILABLE LED COLOURS

cool white, warm white, yellow, orange, pink, purple, red, blue, water blue, green, multicolor





LED TECHNOLOGY

TECHNOLOGIA LED

LEDs can be a source of visible and also infra red light. LED is also known as Light Emitting Diode, which illuminates as the electricity flows from anode p to cathode n. The electricity is provided by auxiliary source of energy which is LED power supply unit. LED lights have a lot of advantages such as small size, long life, low heat emission and power consumption, endurance and brightness of illumination.



Diody świecące są źródłem światła widzialnego oraz dzięki specjalnej budowie promieniują niewidzialne fale podczerwieni. Znane są też pod nazwą diody LED (Light Emitting Diode), które pod wpływem przepływu prądu z anody p do katody n emitują promieniowanie widzialne. Prąd w postaci jonów lub elektronów uzyskiwany jest z zewnętrznego źródła energii (zasilacza LED). Diody świecące mają bardzo dużo zalet, do których należą: małe rozmiary, bardzo długa żywotność, znikoma emisja ciepła, odporność na wstrząsy, niezawodne działanie, małe zużycie energii przy małych stratach mocy oraz duża wartość iluminacji.

POLAMP corporation offers several LED taints:
Firma POLAMP Sp. z o.o. oferuje barwy LED:

- **cold white / biały zimny**
- **neutral white / biały neutralny**
- **warm white / biały ciepły**
- **classic white / biały klasyczny**
- **yellow / żółty**
- **purple / fioletowy**
- **pink / różowy**
- **red / czerwony**
- **orange / pomarańczowy**
- **blue / niebieski**
- **water blue / niebieski morski**
- **green / zielony**
- **multicolour / multikolor**
- **RGB**

It is a professional method of connecting our illumination products. Hermetic plug guarantees safety in bad weather conditions such as rain, snow, moisture. Furthermore, super - connect system is very easy and convenient to use, which is why it works in a plug and play pattern.

Technologia super-połączenie z ang. Super-connect jest profesjonalną metodą szybkich połączeń naszych produktów oświetleniowych. Hermetyczne zamknięcie daje gwarancję bezpiecznego użytkowania w ciężkich warunkach atmosferycznych tj.: deszcz, śnieg, wilgoć. Ponadto system super-połączenie jest niezwykle łatwy i wygodny w użyciu, dlatego często można spotkać określenie z ang. Easy-connect.

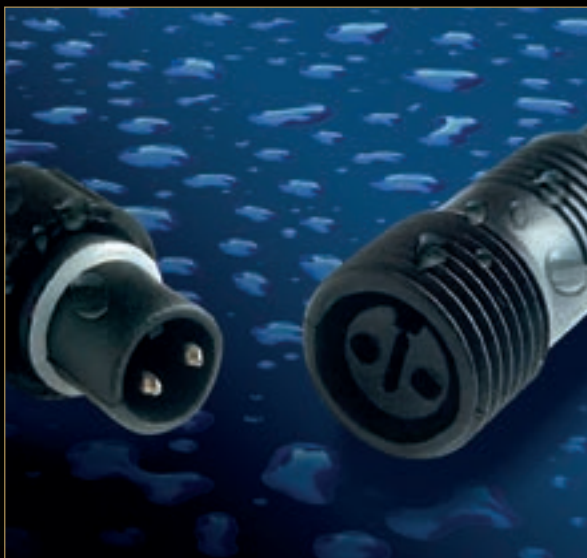

nice and tight 

safely 

easily 

quickly 

Weather resistant

Odporność na warunki
atmosferyczne



LIGHT DECORATIONS / DEKORACJE ŚWIETLNE

DECORATION TYPES / RODZAJE DEKORACJI

Our light decorations can be mounted in a variety of ways. Pole mounted and park decorations are most popular. Thanks to patented brackets they are easily and safely mounted and dismantled. In addition our decorations can be purchased without a frame so that they can adorn a window or a Christmas tree. 3D pole mounted decorations are growing in popularity. Made of a minimum of two elements, they entwine the street light's post or light cover. We also produce over-the-street and facade decorations. As of yet, module decorations are the largest light decorations in our offer. They often adorn central islands in roundabouts. Large 3D decorations are affixed directly to the pavement.

Iluminacje naszej produkcji mogą być zamontowane na wiele sposobów. Najbardziej popularne są dekoracje latarniowe i parkowe. Dzięki zastosowaniu opatentowanego uchwytu powieszenie i demontaż naszej iluminacji jest prostą i bezpieczną czynnością. Ponadto nasze iluminacje, mogą być wyprodukowane bez stelażu do samodzielnego powieszenia np.: na choince lub oknie. Coraz większą popularność zdobywają iluminacje latarniowe 3D. Ozdoba jest złożona z minimum dwóch części, co pozwala na otoczeniu słupa bądź kłosa ze wszystkich stron. W naszej ofercie występują także iluminacje uliczne tzw. przewieszki oraz elewacyjne. Gabarytowo największe są jednak iluminacje modułowe szczególnie popularne na ronda oraz duże dekoracje 3D, które są przytwierdzone bezpośrednio do podłoża.

Decoration types - place and manner of installation / Rodzaje dekoracji - miejsce i sposób montażu



hanging decoration
dekoracja wisząca

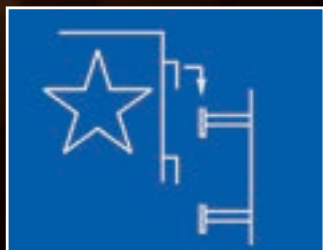

pole mounted decoration
dekoracja latarniowa 2D



park decoration
dekoracja parkowa 2D

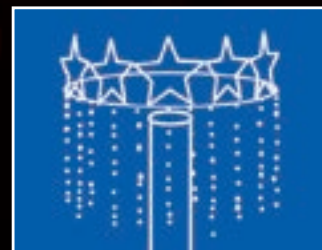

pole mounted 3D decoration
dekoracja latarniowa 3D



over-the-street decoration
dekoracja uliczna - przewieszka



facade decoration
dekoracja elewacyjna

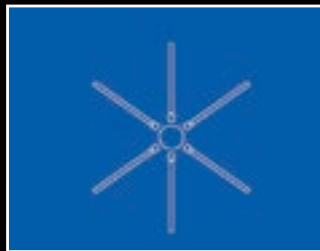

3D module decoration
dekoracja modułowa 3D



3D decoration
dekoracja wolnostojąca 3D (fontanna)

Types of standing 3D decorations / Rodzaje dekoracji wolnostojących 3D



Giant figures, baubles, presents, stars, snowflakes, spheres, balloons, cottages...

figury giganty: bombki, prezenty, gwiazdy, śnieżynki, kule, balony, chatki...



Giant characters: angels, queens, snowmen, Santa Claus, teddy bears, reindeers, other animals...

postacie giganty: anioły, królowny, bałwany, mikołaje, misie, renifery, inne zwierzęta ...



Giant vehicles with seats: sleighs, carriages, cars, buses, tanks...

pojazdy giganty z opcją siedzenia: sanie, karoce, samochody, autobusy, czołgi...



Christmas trees, trees, shrubs, flowers

choinki, drzewa, krzewy, kwiaty



Objects with sponsons to be placed on the water: boats, sleighs, swans, sailers...

obiekty nawodne z pływakami: łodzie, sanie, łabędzie, żaglowiec...



Giant figures with passage: presents, baubles, stars, snowflakes...

figury giganty z opcją przejścia: prezenty, bombki, gwiazdy, śnieżynki...



Imitations of architectonic elements: columns, copings

imitacje elementów architektonicznych: kolumny, sklepienia



Gates, standing or suspended tunnels

bramy, tunele wolnostojące lub podwieszane

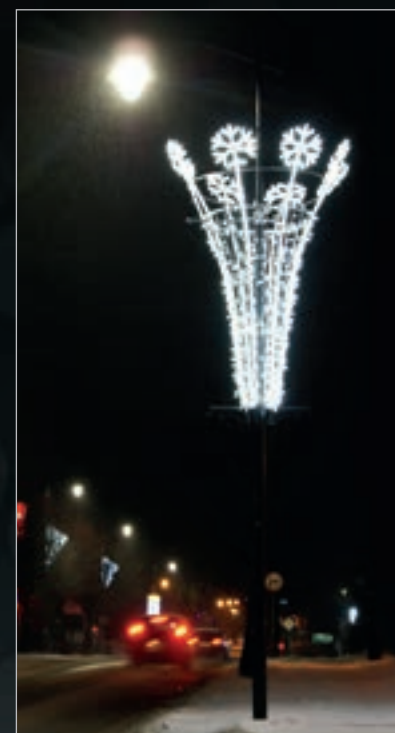



Instalation / Montaż

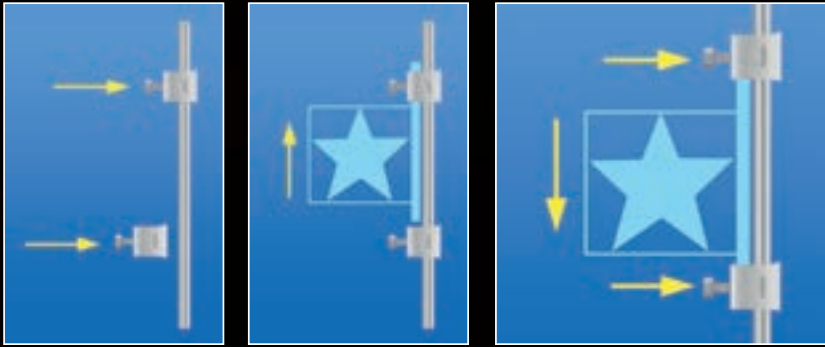

- install upper bracket
- install lower bracket (add -5 cm)
- zamontować górny uchwyt
- zamontować dolny uchwyt z zapasem ok. 5 cm

- slide the frame into upper bracket
- stelaż wsunąć w górny uchwyt

- lower the frame and slide into lower bracket
- hand-screw the knobs (do not use a wrench)
- if need be, use tape as spacer to prevent the knob from damaging the aluminum frame
- stelaż opuścić i wsunąć w dolny uchwyt
- ręcznie dokręcić śruby (bez użycia klucza)
- ewentualnie podłożyć resztki uciętej taśmy w miejsce dokręcania śruby do stelażu, aby zapobiec „wgrzywaniu się śruby” w profil aluminiowy

Every decoration comes with a set of brackets, which make their installation easy. The brackets can remain affixed to a pole outside the Christmas season, when decorations are removed. Once secured, they make future mountings a breeze, while also allowing our customers to save money on steel straps and other installation materials.

Upon request, we provide durable bases and fences. Additional supplies may be also purchased from us, such as: installation tools, steel straps, steel wire rope, wire rope clamps, grips, plastic junction boxes, steel cable ties, plastic cable ties, buckles, hooks, anchors, turnbuckles, carabiners, steel chains and wall-mounted mounting brackets (available w/ outlet and/or dusk to dawn sensor).

Uwzględniając zapotrzebowanie rynku oferujemy łatwy sposób montażu naszych ozdób. Do każdego naszego wzoru oferujemy uchwyty. Pozwalają one na łatwy montaż i pozostawienie ich na stałe przy lampie. Skracza to w następnych latach czas montażu, a także oszczędza zużycie taśmy stalowej bądź innych materiałów do montażu.

Na życzenie produkujemy solidne podstawy i ogrodzenia. Ponadto aby ułatwić montaż oferujemy: narzędzia do montażu, taśmy stalowe, linki stalowe, zaciski, uchwyty dystansowe, puki plastikowe, opaski stalowe zaciskowe, opaski plastikowe zaciskowe, klamry, haki, kotwy mocujące, śruby rzymskie, karabińczyki, łańcuchy stalowe, ściennie wsporniki montażowe z gniazdkiem lub bez, a także z czujnikiem zmierzchowym.

Example of frame assembly for 3D pole mounted decoration.
 Przykładowy schemat konstrukcji do montażu dekoracji 3D na słupie latarniowym.



An example manner of installing 2D decoration on a lamp post. / Przykład montażu dekoracji płaskiej (2D) na słupie latarni.



An example manner of installing 3D decoration on a lamp post. / Przykład montażu dekoracji 3D na słupie latarni.



Installation accessories / Akcesoria do montażu



decoration bracket
uchwyt do ozdób



strapping tensioner
napinarka do taśmy



steel strap
taśma stalowa



steel cable ties
opaski stalowe



plastic cable ties
opaski plastikowe

The fundamental aspect of our products is their durability. Perhaps not so easily noted, it ensures their safe usage.
Podstawą każdej naszej dekoracji jest solidna konstrukcja. Jest to element prawie niewidoczny jednak istotny dla bezpieczeństwa użytkownika.

TIG technology / Technologia TIG

TIG (Tungsten Inert Gas) welding uses tungsten electrode protected by inert shielding gas (argon, helium or a mixture of the two). Alternating current unit allows TIG welding to produce welds of much higher quality than traditional welds.

Metoda spawania nietopliwą elektrodą wolframową w osłonie gazów obojętnych takich jak: argon, hel lub ich mieszanka. TIG (tungsten inert gas) największe zastosowanie znajduje przy łączeniu aluminium z użyciem prądu przemiennego ze względu na uzyskiwanie lepszych złączy niż przy spawaniu gazowym. Zaletą tej metody spawania jest jakość połączeń oraz jakość spoin.



Painting / Malowanie

Upon request we give the aluminum frame a coat of paint.
Na życzenie klientów możemy dodatkowo pokryć aluminium konstrukcji farbą.



Components of light decorations / Elementy dekoracji świetlnej

Basic components are LED rope lights, LED lights and mats. Additional components include flashing LED rope lights, LED strip lights, programmable LED lights, flashing LED lights, LED meteorite shower lights, LED curtains, programmable LED curtains, flashing LED curtains, bulbs (also /w flash), PVC baubles and star ornaments, garlands and bows.

Weże LED, lampki LED i maty to podstawowe elementy dekoracji świetlnej. Dodatkowo stosuje się: węże LED flash, paški LED, lampki z programatorem, lampki z efektem flash, meteorki LED, kurtyнки LED, kurtyнки LED z programatorem, kurtyнки LED z efektem FLASH, żarówki szczególnie FLASH, bombki i gwiazdki PCV, girlandy świerkowe, kokardy.



LED rope light available in 9 basic colours, either single or doubled

węże LED w 9 podstawowych kolorach, mocowany pojedynczo lub podwójnie

LED lights, LED curtains available in 8 basic colours

lampki LED, kurtyнки LED w 8 podstawowych kolorach

mats - various colours available
 mata - dostępne różne kolory

Rope light thickness / Ilość węża

Doubled rope light increases decoration's luminosity. Każda iluminacja może być podwójnie opleciona wężem. Wzmocni to intensywność światła.



Remote controlled for convenience

Wygodne sterowanie pilotem.



Microcontroller - light effects / Programator - efekty świetlne



Microcontrollers sequence circuits of lights, which makes the decoration appear to be in motion. They can be programmed to produce a wide array of lighting effects or even complex sequences in single- or multiple-microcontroller operated systems. We sell remote controlled microcontrollers both for single decorations and for decorative lighting systems. For especially expansive decorative lighting systems we've prepared microcontrollers with radio communication modules with Zigbee specification. The wireless connection makes creation of joint illumination systems easy.

Sterowniki idealnie nadają się do ożywienia dekoracji poprzez sterowanie przepływem światła w lampkach, kurtynach, meteorkach itp. Zapewniają dużą różnorodność uzyskiwanych efektów oraz możliwość tworzenia całych scenariuszy sterowania w układach jedno- i wielosterownikowych. W ofercie posiadamy sterowniki zarówno do pojedynczych dekoracji jak i dla całych systemów oświetlenia ze zdalnym sterowaniem. Do sterowania iluminacjami na rozległym obszarze oferujemy urządzenia z wbudowanymi modułami komunikacji radiowej wg protokołu ZigBee. Umożliwiają one budowę spójnie zarządzanych systemów iluminacji na obszarach ulic, placów, parków, budowli.

Every piece of decorative lighting is thoroughly examined: after trial assembly it undergoes durability and functionality tests. LEDs are inspected and we make sure if the decoration had been produced in accordance with the project.

Każda ozdoba zanim trafi na miejsce docelowe jest w całości składana na hali produkcyjnej i testowana pod względem wytrzymałościowym i funkcjonalnym. Sprawdzane jest oświetlenie LED i zgodność z projektem.



LIGHT DECORATIONS / DEKORACJE ŚWIETLNE

EXAMPLE DESCRIPTIONS OF DECORATIONS

PRZYKŁADOWE OPISY DEKORACJI PRZY ZAMÓWIENIU



3D LED decorations in the form of sitting Santa Claus with 2 presents – POL-0973M, 200 cm width, 170 cm height. The decoration is based on aluminium chassis. 25/25/2 aluminium moulding and round aluminium rod, min. 8 mm diameter. The weight of the chassis itself is minimum 25 kg.

See the catalogue for the available colours of the light. The structure and the outlines are covered with LED rope lights, min. 13 mm diameter, min. 36 vertically placed LEDs per running metre. The figure is filled with LED lights, whose density is 100 LEDs per 10 m. They have the form of type H03RN-F wire with the minimum gauge of 1x0,5 mm. The total amount of LEDs is minimum 1500.

The ornament is filled with metallised mat, 5x5 cm mesh in available colours from the catalogue. Everything is connected with quick release plates, as well as IP44 sockets and plugs. The decoration is equipped with type N8 IP54 switchboard. Standalone structure with deadweight supports*.

Dekoracje LED 3D- w formie Mikołaja siedzącego z dwoma prezentami - POL- -0973M o wymiarach: 200cm szerokość, 170cm wysokość. Ozdoba wykonana na bazie stelaża aluminiowego. Profil aluminiowy 25/25/2 oraz pręt okrągły aluminiowy min. fi8.waga samego stelażu min. 25kg.

Kolor światła według katalogu. Konstrukcja, obrysy pokryte węzłem LED o przekroju min. 13mm i min. 36 diod LED/mb ułożonych wertykalnie. Figura wypełniona lampkami choinkowymi ze 100 punktami LED na 10m na przewodach o minimalnym przekroju 1x0,5mm i typie H03RN-F. Łączna ilość punktów świetlnych min. 1500 LED.

Ozdoba wypełniona matą metalizowaną oczko 5x5cm w kolorze według katalogu. Wszystko połączone metodą szybko złączek oraz gniazd i wtyczek IP44. W ozdobie zamontowana rozdzielnia typu N8 IP54. Konstrukcja wolnostojąca, posiadająca rusztbalastowy.



POL-1204 3D decoration – 250x100 cm cone – cool white snowflake, cone's inner parts in blue colour. LED ornament to be placed on a lantern – 250x100 cm with connecting wires and installation elements. The decoration is based on aluminium chassis in the shape of cone, welded using the TIG method from 20/20/2 and 20/10/2 rectangular moulding.

The frame is to be installed on special lantern clamps. The whole decoration's surface contains min. 650 LEDs. The ornament is composed of min. 1 set of LED lights (100 LEDs, 1x0,5 mm type H03RN-F wire). The snowflake is based on a structure which is covered with LED rope lights (min. 13 mm diameter and 36 LEDs per 1 m, CE and manufacturer's markings every 1 m). The rope lights are attached to the structure with 160/2,5 mm polyamide ties every 2-3 LEDs. Min. 2x0,7 mm type H05RN-F power cord, everything is connected with type "POL" IP44 quick release plates. The rated power is approximately 67 W. Special lantern clamps.

The clamps are made on an eccentric press (without the use of a welding machine) from 2mm grade 5235 sheet metal. The clamps are galvanised and have 2 20mm holes for 19mm steel strip and a hole for 8mm screw for attachment to a post.

Przestrzenna dekoracja POL-1204 - ROŻEK, 250x100 cm - płatek śniegu kolor biały zimny, kolor wnętrza różka niebieski. Dekoracja LED zawieszana na latarnie - o wymiarach 250x100cm wraz z przewodami przyłączeniowymi i elementami montażowymi. Ozdoba ma być wykonana na konstrukcji aluminiowej w kształcie różka, spawana metodą TIG z profilu prostokątnego o przekroju minimum 20/20/2 i 20/10/2.

Ramka przygotowana do montażu na uchwyty słupowe. Na powierzchni całej ozdoby minimum 650 punktów świetlnych LED. Ozdoba ma składać się z min. 1 kompletu lampek choinkowych ze 100 punktami LED na przewodach o minimalnym przekroju 1x0,5mm i typie H03RN-F. Płatek śniegu ma się składać z konstrukcji, która jest pokryta węzłem led o przekroju min. 13mm i 36 diod led/1m, na każdym metrze symbol bezpieczeństwa CE oraz oznakowanie producenta. Wąż przytwierdzony do konstrukcji opaskami 160/2,5mm z poliamidu co 2-3 diody. Kabel zasilający o przekroju min. 2x0,7mm i typie H05RN-F, wszystko połączone metodą szybko-złączek typu „POL”, IP44. Moc zainstalowana elementu ok. 67 (W).

Uchwyty mocujące ozdoby na latarniach wykonane na prasie mimośrodowej (bez użycia spawarki) z blachy o grubości 2mm o gatunku S235, ocynkowane galwanotechnicznie. Uchwyt posiada dwa otwory 20mm na taśmę stalową 19mm oraz otwór na śrubę 8mm celem przytwierdzenia ozdoby do słupa.

POL-0713 3D decoration – cylinder with a crown ornament on the top – 120/80 cm – blue, yellow crown.

120x80 cm 3D LED ornament to be placed on a lantern with connecting wires and installation elements.

The decoration is based on aluminium chassis in the shape of circle, welded using the TIG method from min. 20/10/2 rectangular moulding .

3 fixing clamps are made of min. 20/20/2 and 15/15/1,5 aluminium moulding. They can be adjusted to fit the thickness of a given lamp post. The clamps are from 2mm aluminium sheet in the shape of min. 12cm/8cm hexagon cut in half. The ornament can have minimum two wheels with fixing clamps.

The whole decoration contains min. 450 LEDs. It can be composed of LED curtain with min. 1x0,5mm type H05RN-F power cords. Everything is connected with type “POL” IP44 quick release plates.

Przestrzenna dekoracja POL - 0713 - walec z ornamentem u góry w postaci korony - 120/80 cm - niebieski, korona żółty.

Dekoracja przestrzenna LED zawieszana na latarnie o wymiarach 120x80 cm wraz z przewodami przyłączeniowymi i elementami montażowymi.

Ozdoba wykonana na konstrukcji aluminiowej w kształcie koła spawanej metodą TIG z profilu prostokątnego o przekroju minimum 20/10/2.

Trzy uchwyty mocujące z profilu aluminiowego o przekrojach minimalnych 20/20/2 i 15/15/1,5 z możliwością regulacji w zależności od grubości słupa. Uchwyty wykonane z blachy aluminiowej 2mm w kształcie przeciętego na pół sześciokąta o wymiarach minimum 12cm/8cm. Ozdoba ma posiadać minimum dwa koła z uchwytami mocującymi.

Na całej ozdobie minimum 450 punktów świetlnych LED. Ozdoba ma składać się z kurtynki LED na przewodach o minimalnym przekroju 1x0,5mm i typie H03RN-F. Korona Ozdoby ma składać się z koła, które ma być pokryta węzłem LED o przekroju min. 13mm i 36 diod LED/1m, kabel zasilający o przekroju min. 2x0,7mm i typie H05RN-F, wszystko połączone metodą szybko złączek typu „POL”, IP44.



LIGHT DECORATIONS / DEKORACJE ŚWIETLNE

VISUALISATION / WIZUALIZACJA

The submission of photographs depicting area to be decorated.
The photographs do not have to be taken during nighttime.

Dostarczenie zdjęć miejsca do udekorowania. Nie muszą to być zdjęcia nocne.



If the submitted photographs were taken during daytime, we perform a simulation of nighttime.

W przypadku braku zdjęć nocnych wykonujemy symulację nocy na zdjęciu dziennym.



The selected decoration is placed in the photograph.

Umieszczenie wskazanej dekoracji na zdjęciu.



The final visualisation of the area. Thanks to the visualisation we can see what the area looks like with the selected decorations, or make possible changes.

Ostateczna wizualizacja miejsca. Dzięki wizualizacji możemy ocenić jak prezentuje się dekoracja w podanym miejscu i dokonać ewentualnych zmian.

Illustrative decorative lighting placement on a large, gothic church
Rozmieszczenie wybranych dekoracji świetlnych na przykładzie dużego, gotyckiego kościoła.

- 1 Facade decoration - white LED rope light LED - POL-0250 / Dekoracja elewacyjna z białego węża LED - POL-0250
- 2 Snowflake - white LED rope light, white LED lights and blue mat - POL-0009M
Śnieżynka z białego węża LED, białych lampek LED i niebieskiej maty - POL-0009M
- 3 Rosette - white LED rope light - POL-0089 / Rozeta z białego węża LED - POL-0089
- 4 Facade decoration - white & blue LED rope light /w meteor shower - POL-0248
Dekoracja elewacyjna z białego i niebieskiego węża LED z meteorkami - POL-0248
- 5 Gate - warm white LED lights, warm white & blue LED rope light - POL-0248
Brama z białych ciepłych lampek LED, białego ciepłego i niebieskiego węża LED - POL-1351
- 6 Nativity Scene - warm white LED lights - POL-1951 / Szopka bożonarodzeniowa z białych ciepłych lampek LED - POL-1951
- 7 Fountain - white LED rope light, white LED lights - POL-1963 / Fontanna z białego węża LED i z białych lampek LED - POL-1963
- 8 Xmas Tree - white LED rope light, blue LED lights - POL-0996 / Choinka z białego węża i z niebieskich lampek LED - POL-0996

Product info description / Wyjaśnienie opisów produktów:

POL-0916 - decoration's model number / numer ozdoby

200x600cm - decoration's dimensions (hgt. x wd.) / wymiary (wys. x szer.)

510W/LED102W - Power (W) incandescent rope light/LED rope light / moc (W) wąż żarówkowy/wąż LED



Every decoration listed in this chapter comes in one of 12 colour styles: cold white, neutral white, warm white, classic white, yellow, orange, pink, purple, red, blue, water blue, green, multicolor, RGB. If RGB lights are used, the decoration can shine in any selected colour. Light colour in individual models can be changed upon request.

Wszystkie prezentowane w tym rozdziale wzory mogą występować w jednym z 12 kolorów: biały zimny, biały neutralny, biały ciepły, biały klasyczny, żółty, pomarańczowy, różowy, fioletowy, czerwony, niebieski, niebieski morski, zielony oraz multikolor i RGB. W przypadku użycia lampek RGB ozdoba może mieć dowolną barwę. Kolor każdego wzoru może zostać zmieniony na życzenie klienta.





Grodzisk Mazowiecki

CHRISTMAS TREES GARLANDS, ORNAMENTS CHOINKI, GIRLANDY, OZDOBY CHOINKOWE

Decorated GIANT cones up to 112 m of height (usually up to 14 m), GIANT cone with RGB modules, small Christmas trees, decorated Christmas trees, wreaths, garlands, baubles, stars, artificial snow, decorations with garland, animated figures.

Stożki GIGANTY z dekoracją do 112 m wysokości (do 14 m standardowo), stożek GIGANT z modułami RGB, choinki małe, choinki z dekoracją, wianki, girlandy, bombki, gwiazdy, sztuczny śnieg, dekoracje z girlandą, animowane figury.

GIANT cones up to 14 m of height (they can be taller on the customer's request)
Stożki GIGANTY do 14 m (wyższe na życzenie)



Small Christmas trees, garlands, wreaths, baubles, stars, artificial snow, decorations with garland, animated figures.
Choinki małe, girlandy, wianki, bombki, gwiazdy, sztuczny śnieg, dekoracje z girlandą, animowane figury.



CHRISTMAS TREES, GARLANDS, PVC ORNAMENTS CHOINKI, GIRLANDY, OZDOBY PCV

DESCRIPTION / OPIS

Giant Christmas trees

The production of Christmas trees by POLAMP dates back to 2009, when the production of mats and conifer needles began. They are the highest quality solutions, weather and UV resistant, but most importantly, they are safe and made from non-flammable materials.

We have construction projects, as well as all the necessary static and durability calculations. Thanks to its structure with ballast elements, a Christmas tree can be installed in the open space and set on levelled and hardened ground, like plaza, market square, etc.

Thanks to the modular structure, the height of a giant POLAMP Christmas tree can reach up to 112 m. Its steel structure is durable and can be disassembled to make the transport easier. The product can have the shape of a cone or a pyramid. The former comes in two variants - elegant or natural (with longer PVC conifer needles). The basic colour of needles is green, and the type - spruce. Similar to its height, type and colour of a Christmas tree are at customer's choice. We can prepare spruce, fir or larch conifer needles in colours like blue, red, silver, golden, etc.

Each 2-metre module is a steel structure coated with anticorrosive layer in the process of galvanisation. The elements can be put one into another, which makes them more convenient to store in the off-season. It is possible to access the inner part of the Christmas tree through a low-profile door in order to install illuminations and do the maintenance.

In our offer we have foundations, platforms, and railings. On customer's request we can put a logo of company or locality.

ATTENTION: Cones' dimensions provided in a further part of the catalogue do not include the tip in the form of a star. Depending on the cone's height, additional 0,5 m to 1,5 m should be added to the height.

Traditional Christmas trees

We have been producing Christmas trees since 2009. They are made from high-quality non-flammable materials which are weather-proof.

The majority of artificial Christmas trees has 200 or 210 cm of height. They have supports so that they are stable, while branches are densely-distributed, which makes the Christmas tree seem like a natural spruce. Green is the most popular colour for the trees we sell.

PVC ornaments

We have been producing Christmas trees since 2009. They are made from high-quality non-flammable materials which are weather-proof.

The majority of artificial Christmas trees has 200 or 210 cm of height. They have supports so that they are stable, while branches are densely-distributed, which makes the Christmas tree seem like a natural spruce. Green is the most popular colour for the trees we sell.

Decorated Christmas trees, GIANT cones

We offer decorated POLAMP Christmas trees which are ready to set up. Our suggested solutions include sets of structures, lights and ornaments in various configurations and colours.

We have cones which consist of the following types of decorations:

- spruce garland + tip + LED string lights
- spruce garland + tip + LED string lights + meteor shower rain lights
- spruce garland + tip + LED string lights + LED rope light
- spruce garland + tip + LED string lights + LED rope light + mat
- spruce garland + tip + LED string lights + LED rope light + PVC ornaments

Choinki GIGANTY

Tradycja produkcji choinek marki POLAMP sięga 2009 roku, kiedy to rozpoczęła się produkcja igliwia i mat świątecznych. Są to rozwiązania najwyższej jakości, odporne na warunki atmosferyczne i promieniowanie UV, nade wszystko - bezpieczne, wykonane z tworzyw niepalnych.

Mamy projekty budowlane i wszelkie niezbędne obliczenia statyczne i wytrzymałościowe. Konstrukcja balastowa choinki może być stawiana na otwartej przestrzeni i posadowiona na wypoziomowanym utwardzonym podłożu, typu plac, płyta rynku, etc.

Dzięki modułowej konstrukcji wysokość gigantycznej choinki POLAMP to nawet 112 metrów. Stalowy stelaż jest wytrzymały a dzięki możliwości demontażu, łatwy do przewożenia. Kształt produktu to stożek lub piramida. Pierwszy występuje w wariantcie elegant lub z dłuższym igliwem PCV - w stożku o nazwie naturalny. Podstawowym kolorem igieł jest zieleń a rodzaj - świerk. Jednak podobnie jak wysokość drzewka, także i jego kolor oraz typ zależy od Klienta. Możemy przygotować igliwie sosnowe, jodłowe, czy modrzewiowe w barwach: niebieskiej, czerwonej, srebrnej, złotej itp.

Każdy z 2-metrowych modułów jest konstrukcją stalową pokrytą powłoką antykorozyjną, powstająca w procesie ocynkowania. Kolejne elementy można schować jeden w drugi, co ułatwia składanie i magazynowanie poza sezonem. Do wnętrza choinki można wejść, dzięki dyskretnym drzwiczkom, pozwalającym na konserwację i montaż oświetlenia.

Dodatkowo oferujemy gotowe fundamenty, podesty i płotki. Można na nie nanieść herb miejscowości, czy logo firmy.

UWAGA: podane w dalszej części katalogu wymiary stożków nie obejmują czubka z gwiazdy. W zależności od wysokości stożka należy doliczyć od 0,5 do 1,5 m.

Choinki Tradycyjne

Choinki produkujemy od 2009 roku. Są wykonane z wysokiej jakości tworzyw niepalnych oraz odpornych na zmieniające się warunki atmosferyczne.

Wysokość sztucznych choinek to 200 lub 210 cm, posiadają nóżki, aby stały stabilnie, gałązki rozmieszczone są gęsto, stąd efekt wizualny do złudzenia przypomina prawdziwy świerk. Najczęściej sprzedajemy choinki w kolorze zielonym.

Ozdoby z PCV

Produkujemy szeroką gamę ozdób z tworzywa sztucznego: gwiazdek i bombek. Uzupełnieniem są dekoracyjne kokardki. Wszystkie oferujemy w 3 kolorach: srebro, złoto i czerwień.

Co roku najwięcej wytwarzamy bombek, oferujemy 7 średnic: 60, 80, 100, 120, 150, 200 i 300 mm. 8-centymetrowe bombki sprzedajemy też w opcji gotowych 10-metrowych sznurów.

Tworzywo PCV jest odporne na warunki atmosferyczne. Ozdoba nie stłucze się, gdy przez przypadek spadnie, nie zmieni swojego nasyconego koloru.

Choinki z dekoracją Stożki GIGANT

Udekorowane choinki POLAMP to nasze gotowe propozycje. Zaproponowane rozwiązania są zestawami konstrukcji, lampek i ozdób w kilku różnych konfiguracjach i kolorach.

Przygotowaliśmy stożki składające się z następujących typów dekoracji:

- girlanda świerkowa + czubek + lampki LED,
- girlanda świerkowa + czubek + lampki LED + meteorki,
- girlanda świerkowa + czubek + lampki LED + wąż LED,
- girlanda świerkowa + czubek + lampki LED + wąż LED + mata,
- girlanda świerkowa + czubek + lampki LED + wąż LED + ozdoby PCV,

CHRISTMAS TREES, GARLANDS, PVC ORNAMENTS CHOINKI, GIRLANDY, OZDOBY PCV DESCRIPTION / OPIS

- spruce garland + tip + LED string lights + LED rope light + meteor shower rain lights
- spruce garland + tip + LED string lights + LED rope light + meteor shower rain lights + mat
- spruce garland + tip + LED string lights + PVC ornaments
- spruce garland + tip + LED string lights + PVC ornaments + meteor shower rain lights
- spruce garland + tip + LED string lights + LED rope light + meteor shower rain lights + PVC ornam.

It is worth to distinguish GIANT cone with RGB modules. It is animated, remotely controlled, and available in various colours. The modules are joined together so that they form chains which when put together form planes. Thanks to the animation, the planes provide spectacular and incomparable light effects.

The height can be adjusted to the needs. The smallest Christmas tree reaches 100 cm of height, whereas the tallest 1400 cm. The following heights are also available: 150, 200, 250, 300, 400, 500, 600, 700, 800, 1000, and 1200 cm.

Christmas trees are symbols of the contemporary times. In the case of these products, the light is the most important, as well as its colour and the way it glows. From the technical point of view, we offer very durable Christmas trees, efficient in terms of lighting, and easy to assemble. Although in the case of maintenance, repair, and installation of a selected model we will be pleased to deliver all the elements and help to create the planned illumination.

Traditional decorated Christmas trees

Traditional Christmas trees made of artificial conifer needles. We offer them in two variants – yet to be decorated by the customer or already decorated.

POLAMP's idea for decoration is to pick the majority of ornaments, if not all of them, in one colour. We offer the example compositions: silver + white, silver + golden, red + golden elements, silver + red and blue baubles.

Christmas trees reaching 225 cm of height have 180 baubles. We also offer Christmas trees of the same height but a little wider, which can have 200 various ornaments. Similar products, such as wreaths or decorated garlands, are offered in the same sets as Christmas trees.

Christmas tree sets do not include LED string lights. We offer a huge range of lights, so the decision is up to the customer.

Garlands

POLAMP garlands are high-quality products, inspired by the nature. We produce them from artificial conifer needles which are resistant to difficult winter atmospheric conditions. In the form of wreaths they serve as door decorations or as arches hung over promenades.

Our products can be ordered with or without ornaments, i.e. LED string lights or small light decorations such as bells or stars. Decorated garlands are mounted on star-shaped profiles and they are additionally decorated with LED lights, so that we get an original decoration to hang, for example on a window.

Straight garlands have 22 cm of diameter and 270 cm of length. The ornament in the shape of a candy is a little shorter – 90 x 20 cm.

The said wreaths, being in our offer, are sold with or without ornaments. They can be an element of a chandelier that is hung on a ribbon.

A novel idea on the Polish market is a portrait which has a garland instead of a standard frame. We offer portraits of Santa Claus, reindeer, and snowman.

- girlanda świerkowa + czubek + lampki LED + wąż LED + meteorki,
- girlanda świerkowa + czubek + lampki LED + wąż LED + meteorki + mata,
- girlanda świerkowa + czubek + lampki LED + ozdoby PCV,
- girlanda świerkowa + czubek + lampki LED + ozdoby PCV + meteorki,
- girlanda świerkowa + czubek + lampki LED + wąż LED + meteorki + ozdoby PCV.

Produktem, który warto wyróżnić Stożek GIGANT z modułami RGB. Dostępny w rozmaitych kolorach, animowany, sterowany pilotem. Moduły połączone są w łańcuchy a te w płaszczyzny, które dzięki animowaniu dają nieporównywalne z niczym innym wielkoformatowe efektowne wrażenia świetlne.

Wysokości można dopasować w zależności od potrzeb. Najniższa choinka mierzy 100 cm a najwyższa 1400 cm. Oprócz nich też 150, 200, 250, 300, 400, 500, 600, 700, 800, 1000 i 1200 cm.

Choinki to symbol współczesności. W tych produktach światło ma największe znaczenie, jego kolor, sposób świecenia. Z technicznego punktu widzenia oferujemy choinki bardzo wytrzymałe, wydajne pod względem świecenia, łatwe w montażu. Choć w przypadku konserwacji, napraw i ustawiania wybranego modelu, z przyjemnością dowieziemy wszystkie elementy i pomożemy w realizacji zaplanowanej iluminacji.

Choinki z dekoracją Tradycyjne

Tradycyjne choinki wykonane ze sztucznego igliwia, proponujemy w formie do dekorowania dla Klienta, ale również już gotowe - przystrojone.

Pomysłem POLAMP na dekorację jest dobranie ozdób w wielkości w jednym określonym kolorze. Oferujemy, np. opcję srebrną z bielą, srebrno-złotą, czerwoną z domieszką elementów złotych, srebrne z domieszką bombek czerwonych i niebieskich.

Drzewka wysokie na 225 cm mają po 180 bombek. Przygotowaliśmy także drzewka o tej samej wysokości, nieco szersze, na których zawieszamy, zgodnie z projektem, 200 rozmaitych ozdób. Według podobnych wzorców dekoracyjnych udostępniamy produkty pokrewne jak wianki, czy girlandy z dekoracjami w podobnych zestawach co choinka.

Zaznaczamy jednak, że zestawy choinkowe nie zawierają lampek LED, ze względu na ich ogromny wybór, pozostawiamy decyzję po stronie Klienta.

Girlandy

Girlandy POLAMP to produkty wysokiej jakości, inspirowane naturą. Tworzymy je ze sztucznego igliwia odpornego na trudne zimowe warunki atmosferyczne. Z powodzeniem służą, w formie wianków, na drzwiach mieszkań lub jako element dekoracji rozwieszony nad deptakiem, tzw. przewieszki.

Produkty można zakupić bez dekoracji, jak i z nimi, z lampkami LED, czy małymi świetlnymi dekoracjami, jak dzwoneczki, czy gwiazdki. Girlandy z dekoracją mocujemy na profilach o kształcie gwiazdy, ozdabiamy dodatkowo diodami LED, dzięki czemu uzyskujemy oryginalną dekorację do powieszenia, np. w oknach.

Girlandy proste mają średnicę 22 cm i długość 270 cm. Ozdoba przypominająca kształt cukierka jest nieco krótsza - 90 x 20 cm.

Wspomniane wianki, będące także częścią naszej oferty, sprzedajemy w wariacie bez ozdób, jak i z ozdobami. Mogą one być elementem np. żyrandola wieszanego na efektownej wstędze.

Wyjątkowym na polskim rynku pomysłem jest portret obramowany girlandą. Oferujemy Mikołaja, renifera i bałwanka.

DECORATED CHRISTMAS TREES / CHOINKI Z DEKORACJĄ

GIANT CONES - comparison of height / STOŻKI GIGANTY - porównanie wysokości

The comparison of giant cone's height. In the catalogue the patterns are presented usually for 8-10-metre-high decorations. The below illustration shows how proportions of the used ornaments change in relation to the cone's surface for 6m, 10m, and 20m respectively.

Porównanie wysokości stożka giganta. W katalogu zwykle prezentowane są wzory dla wysokości 8-10 m. Rysunek poniżej pokazuje jak zmieniają się proporcje użytych ozdób w stosunku do powierzchni stożka odpowiednio dla: 6m, 10m, 20m.

AVAILABLE LED COLOURS DOSTĘPNE KOLORY LED

cold white, neutral white, warm white, classic white, yellow, orange, pink, purple, red, blue, water blue, green, multicolor, RGB

biały zimny, biały neutralny, biały ciepły, biały klasyczny, żółty, pomarańczowy, różowy, fioletowy, czerwony, niebieski, niebieski morski, zielony, multikolor, RGB

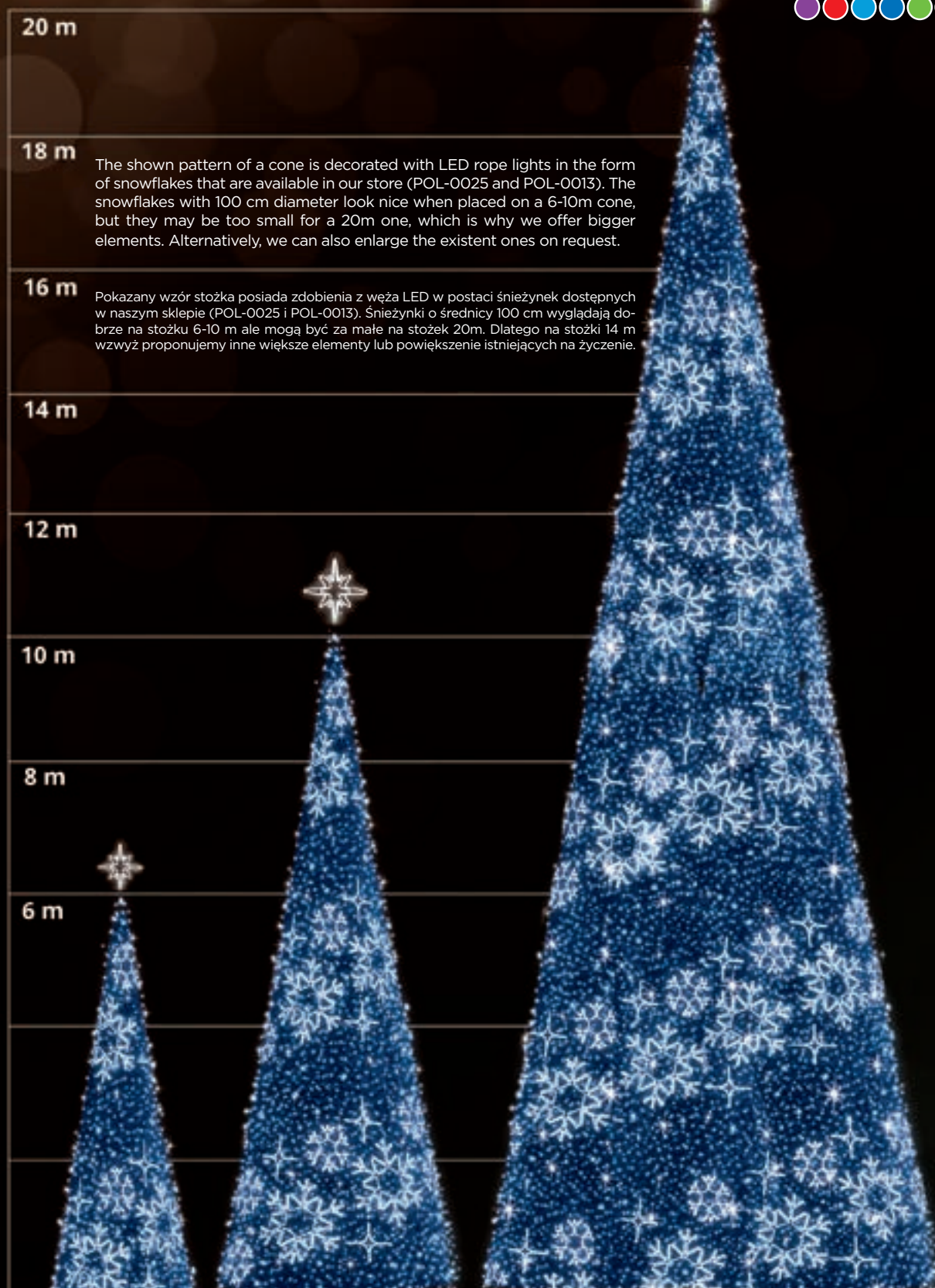

Because of its price, the easiest and the most popular ornament is a cone decorated with LED lights only. It can also serve as a base for other patterns of surface, covered with LED rope lights and PVC ornaments.

Najprostszym i najbardziej popularnym ze względu na cenę jest stożek ozdobiony samymi lampkami LED. Jest to też stożek bazowy do pozostałych wzorów choinek z węzłem LED i ozdobami PCV.

STD01

-  garland green spruce
-  tip model POL617
-  LED lights cool white + FLASH

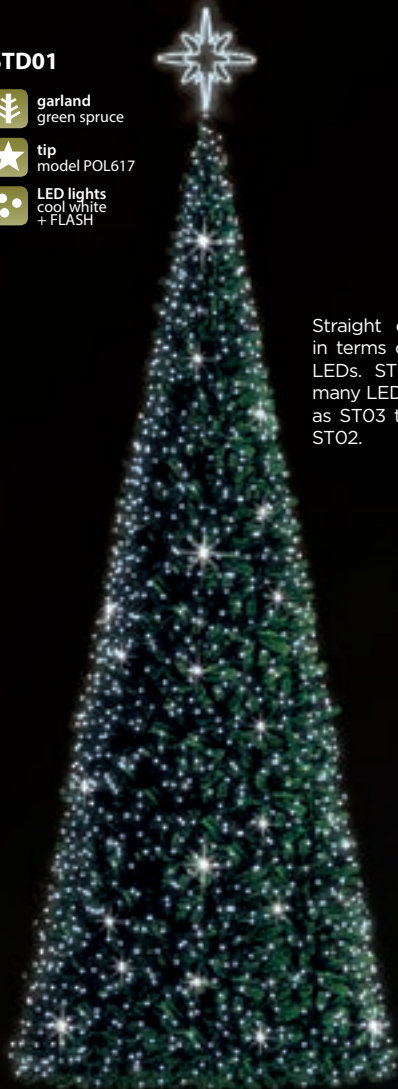

STD02

-  garland green spruce
-  tip model POL617
-  LED lights cool white + FLASH

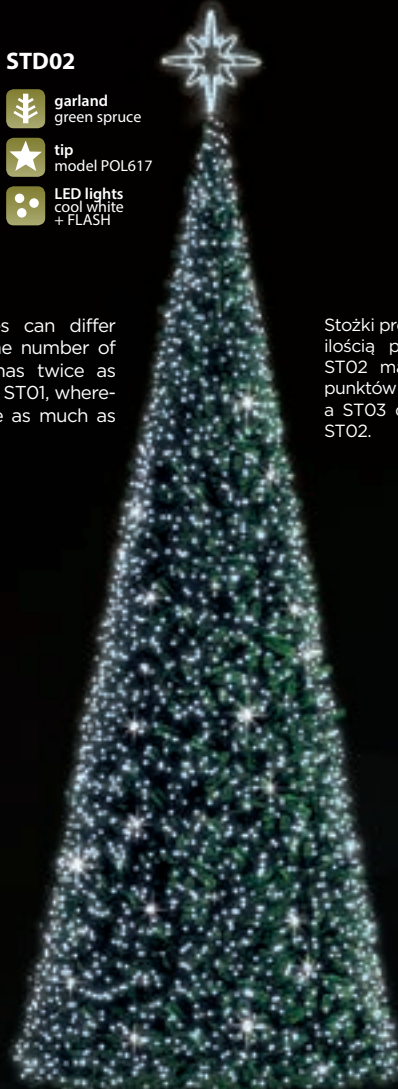

Straight cones can differ in terms of the number of LEDs. ST02 has twice as many LEDs as ST01, whereas ST03 twice as much as ST02.

STD03

-  garland green spruce
-  tip model POL617
-  LED lights cool white + FLASH

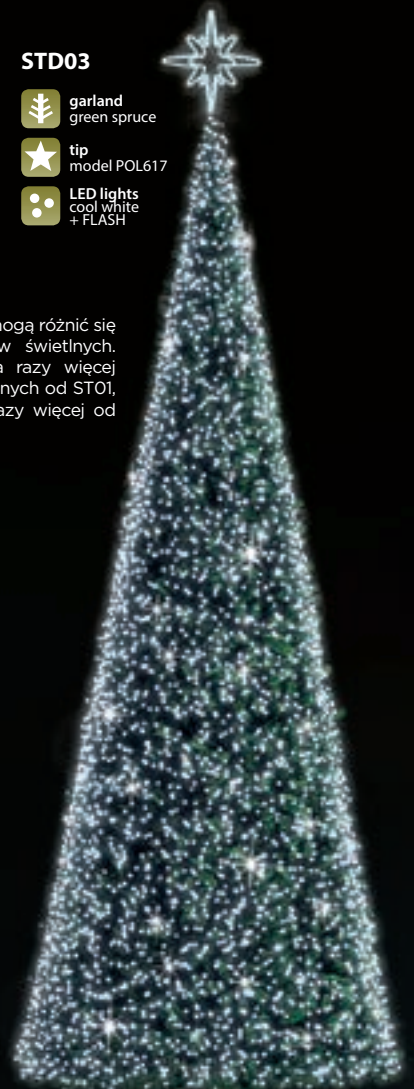

Stożki proste mogą różnić się ilością punktów świetlnych. ST02 ma dwa razy więcej punktów świetlnych od ST01, a ST03 dwa razy więcej od ST02.

CONE / STOŻEK

height wysokość	diameter średnica	weight waga
100	50	9
150	65	11
200	80	18
250	95	38
300	110	50
400	150	83
500	170	145
600	200	223
700	230	295
800	265	336
1000	325	650
1200	385	980
1400	450	1400

MODULAR STRUCTURE

BUDOWA MODUŁOWA



Cones are available in heights: 20, 30, 50 ... to 112 m. Dimensions listed in centimeters, weight in kilograms. Listed weight does not include weight of decorations.

Możliwość instalacji stożka o wysokości: 20, 30, 50 ... do 112 m. Wymiary podane są w centymetrach, waga w kilogramach. Waga nie obejmuje ciężaru ozdób.

Listed cone heights do not include the LED rope light topper. Add: 50 cm for cones to 6 m, 100 cm for cones to 10 m, 150 cm for cones to 14 m. I.e. 12 m cone (1200cm in table) will have total height of 13,5 m.

Podane wysokości stożka nie obejmują czubka z węzła LED. Do każdej z nich należy dodać: 50 cm przy stożkach do 6m, 100 cm przy stożkach do 10 m i 150 cm przy stożkach do 14 m. Np. Stożek 12 m (1200 cm w tabeli) będzie miał końcową wysokość 13,5 m.

STD01 6m



STD02 6m







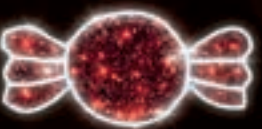

STD03 6m



DECORATED CHRISTMAS TREES / CHOINKI Z DEKORACJĄ
GIANT CONES / STOŻKI GIGANTY



STD99

-  garland
green spruce
-  tip
model POL617
-  LED lights
warm white,
FLASH, red
-  LED rope
cool white
-  mat
red, purple, gold, green
-  PVC ornaments
gold, purple baubles





AVAILABLE LED COLOURS
DOSTĘPNE KOLORY LED

cold white, neutral white, warm white,
classic white, yellow, orange, pink, purple,
red, blue, water blue, green, multicolor, RGB

biały zimny, biały neutralny, biały ciepły,
biały klasyczny, żółty, pomarańczowy,
różowy, fioletowy, czerwony, niebieski,
niebieski morski, zielony, multikolor, RGB



STD100

-  garland
green spruce
-  tip
model POL617
-  LED lights
warm white, flash
-  LED rope
cold white
-  mat
gold
-  PVC ornaments
gold, red baubles



CONE / STOŻEK

height wysokość	diameter średnica	weight waga
100	50	9
150	65	11
200	80	18
250	95	38
300	110	50
400	150	83
500	170	145
600	200	223
700	230	295
800	265	336
1000	325	650
1200	385	980
1400	450	1400

**MODULAR
STRUCTURE**

BUDOWA
MODUŁOWA



Cones are available in heights: 20, 30, 50 ... to 112 m. Dimensions listed in centimeters, weight in kilograms. Listed weight does not include weight of decorations.

Możliwość instalacji stożka o wysokości: 20, 30, 50 ... do 112 m. Wymiary podane są w centymetrach, waga w kilogramach. Waga nie obejmuje ciężaru ozdób.

Listed cone heights do not include the LED rope light topper. Add: 50 cm for cones to 6 m, 100 cm for cones to 10 m, 150 cm for cones to 14 m. I.e. 12 m cone (1200cm in table) will have total height of 13,5 m.

Podane wysokości stożka nie obejmują czubka z węża LED. Do każdej z nich należy dodać: 50 cm przy stożkach do 6m, 100 cm przy stożkach do 10 m i 150 cm przy stożkach do 14 m. Np. Stożek 12 m (1200 cm w tabeli) będzie miał końcową wysokość 13,5 m.



DECORATED CHRISTMAS TREES / CHOINKI Z DEKORACJĄ
GIANT CONES / STOŻKI GIGANTY



STD87



garland
green spruce



LED lights
cool white,
blue, FLASH



tip
model POL617



LED rope
warm white

STD88



garland
green spruce



LED lights
cool white,
blue, FLASH



tip
model POL617



LED rope
warm white

STD89



garland
green spruce



LED lights
warm white,
FLASH



tip
model POL617



LED rope
cool white

New in our offer. The cone is covered with green garland with LED lights in stripes every 1m, interspersed with transparent surface of the same height, filled only with LED rope lights. As a result, the cone appears to be lighter, while the structure's transparency contributes to the play of light between the cone and the street lighting.

Nowość w naszej ofercie. Stożek pokryty jest zieloną girlandą z lampkami LED w pasach co 1 m, na przemian z półprzezroczystą powierzchnią o tej samej wysokości wypełnioną tylko węzłem LED. Dzięki temu sprawia wrażenie lżejszego, a częściowa przenikliwość konstrukcji pozwala na większą grę światła zarówno z samego stożka jak i z oświetlenia przestrzeni miejskiej.

**AVAILABLE LED COLOURS
DOSTĘPNE KOLORY LED**

cold white, neutral white, warm white,
classic white, yellow, orange, pink, purple,
red, blue, water blue, green, multicolor, RGB

biały zimny, biały neutralny, biały ciepły,
biały klasyczny, żółty, pomarańczowy,
różowy, fioletowy, czerwony, niebieski,
niebieski morski, zielony, multikolor, RGB



CONE / STOŻEK

height wysokość	diameter średnica	weight waga
100	50	9
150	65	11
200	80	18
250	95	38
300	110	50
400	150	83
500	170	145
600	200	223
700	230	295
800	265	336
1000	325	650
1200	385	980
1400	450	1400

**MODULAR
STRUCTURE**

**BUDOWA
MODUŁOWA**



Cones are available in heights:
20, 30, 50 ... to 112 m. Dimensions
listed in centimeters, weight in
kilograms. Listed weight does not
include weight of decorations.

Możliwość instalacji stożka o wysokości:
20, 30, 50 ... do 112 m. Wymiary podane
są w centymetrach, waga w kilogramach.
Waga nie obejmuje ciężaru ozdób.

Listed cone heights do not include the LED rope light topper. Add:
50 cm for cones to 6 m, 100 cm for cones to 10 m, 150 cm for cones
to 14 m. I.e. 12 m cone (1200cm in table) will have total height of 13,5 m.

Podane wysokości stożka nie obejmują czubka z węża LED. Do każdej
z nich należy dodać: 50 cm przy stożkach do 6m, 100 cm przy stożkach do
10 m i 150 cm przy stożkach do 14 m. Np. Stożek 12 m (1200 cm w tabeli)
będzie miał końcową wysokość 13,5 m.



DECORATED CHRISTMAS TREES / CHOINKI Z DEKORACJĄ





GIANT CONES / STOŻKI GIGANTY







STD90

-  garland
green spruce
-  tip
model POL617
-  LED lights
cool white,
FLASH
-  LED rope
cool white
-  PVC ornaments
golden baubles

STD91

-  garland
green spruce
-  tip
model POL617
-  LED lights
cool white,
FLASH
-  LED rope
cool white
-  PVC ornaments
golden baubles

STD92

-  garland
green spruce
-  tip
model POL617
-  LED lights
warm white,
FLASH
-  LED rope
cool white
-  PVC ornaments
golden baubles

CONE / STOŻEK

height wysokość	diameter średnica	weight waga
100	50	9
150	65	11
200	80	18
250	95	38
300	110	50
400	150	83
500	170	145
600	200	223
700	230	295
800	265	336
1000	325	650
1200	385	980
1400	450	1400

**MODULAR
STRUCTURE**

**BUDOWA
MODUŁOWA**



Cones are available in heights: 20, 30, 50 ... to 112 m. Dimensions listed in centimeters, weight in kilograms. Listed weight does not include weight of decorations.

Możliwość instalacji stożka o wysokości: 20, 30, 50 ... do 112 m. Wymiary podane są w centymetrach, waga w kilogramach. Waga nie obejmuje ciężaru ozdób.

Listed cone heights do not include the LED rope light topper. Add: 50 cm for cones to 6 m, 100 cm for cones to 10 m, 150 cm for cones to 14 m. I.e. 12 m cone (1200cm in table) will have total height of 13,5 m.

Podane wysokości stożka nie obejmują czubka z węża LED. Do każdej z nich należy dodać: 50 cm przy stożkach do 6m, 100 cm przy stożkach do 10 m i 150 cm przy stożkach do 14 m. Np. Stożek 12 m (1200 cm w tabeli) będzie miał końcową wysokość 13,5 m.

These Christmas trees are an embodiment of modernity. The most significant aspect of these products is light they produce, its type and colour. Our Christmas trees are extremely durable, efficient and easy to assemble. If you require assistance with maintenance, repairs or installation, we'll be happy to deliver all necessary parts and help you arrange your perfect decorative light display.

Choinki to symbol współczesności. W tych produktach światło ma największe znaczenie, jego kolor, sposób świecenia. Z technicznego punktu widzenia oferujemy choinki bardzo wytrzymałe, wydajne pod względem świecenia, łatwe w montażu. Choć w przypadku konserwacji, napraw i ustawiania wybranego modelu, z przyjemnością dowiemy wszystkie elementy i pomożemy w realizacji zaplanowanej iluminacji.



**AVAILABLE LED COLOURS
DOSTĘPNE KOLORY LED**

cold white, neutral white, warm white, classic white, yellow, orange, pink, purple, red, blue, water blue, green, multicolor, RGB

biały zimny, biały neutralny, biały ciepły, biały klasyczny, żółty, pomarańczowy, różowy, fioletowy, czerwony, niebieski, niebieski morski, zielony, multikolor, RGB









DECORATED CHRISTMAS TREES / CHOINKI Z DEKORACJĄ
GIANT CONES / STOŻKI GIGANTY







STD93

-  garland
green spruce
-  tip
model POL617
-  LED lights
warm white,
FLASH
-  LED rope
warm white
-  mat
red
-  PVC ornaments
golden baubles
red baubles

STD94

-  garland
green spruce
-  tip
model POL617
-  LED lights
cool white,
FLASH, red
-  LED rope
cool white
-  mat
red
-  PVC ornaments
red baubles

STD95

-  garland
green spruce
-  tip
model POL617
-  LED lights
warm white,
FLASH, red
-  LED rope
warm white
-  mat
gold
-  PVC ornaments
golden baubles

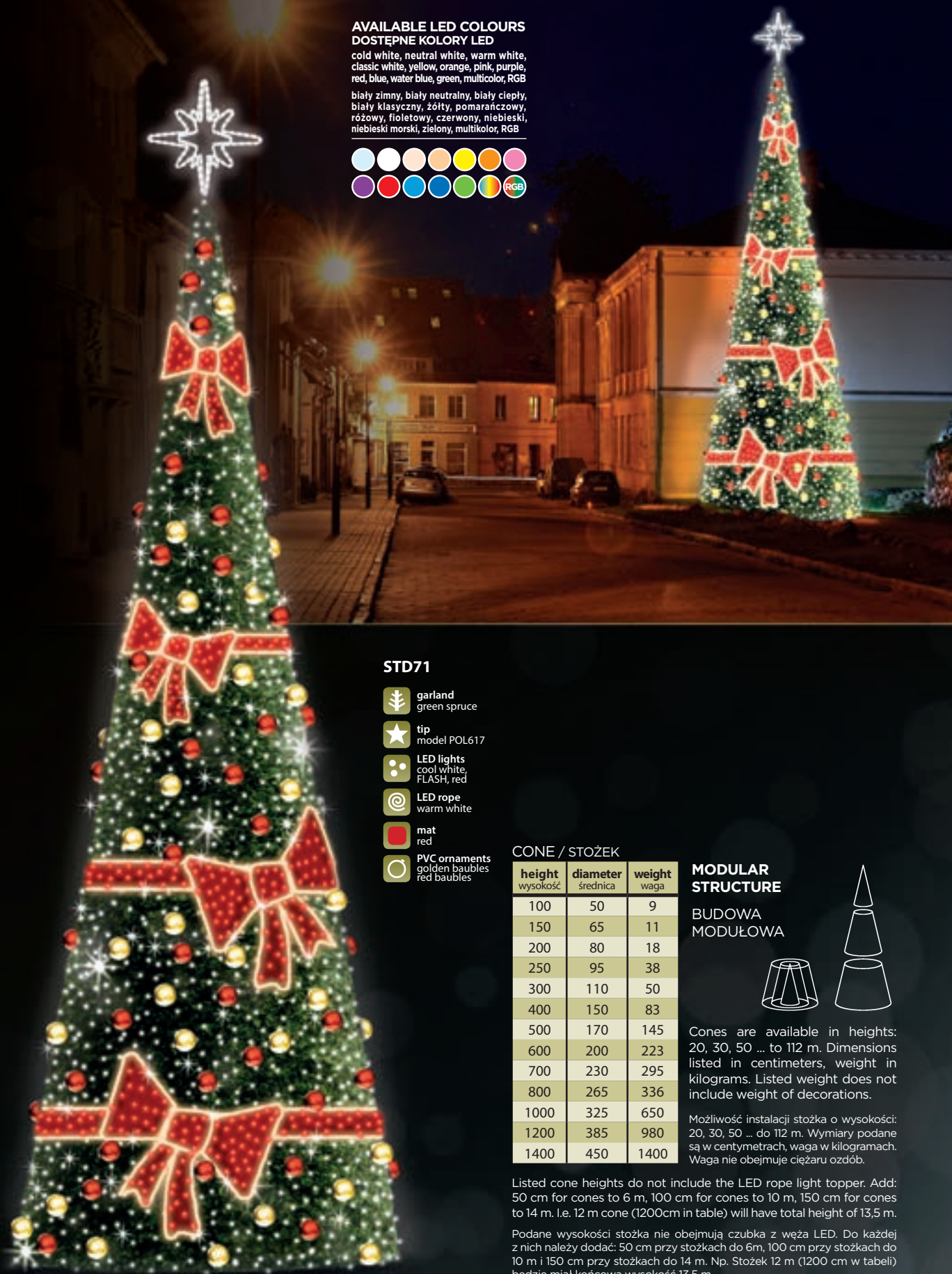

**AVAILABLE LED COLOURS
DOSTĘPNE KOLORY LED**

cold white, neutral white, warm white,
classic white, yellow, orange, pink, purple,
red, blue, water blue, green, multicolor, RGB

biały zimny, biały neutralny, biały ciepły,
biały klasyczny, żółty, pomarańczowy,
różowy, fioletowy, czerwony, niebieski,
niebieski morski, zielony, multikolor, RGB



STD71

-  garland
green spruce
-  tip
model POL617
-  LED lights
cool white,
FLASH, red
-  LED rope
warm white
-  mat
red
-  PVC ornaments
golden baubles
red baubles

CONE / STOŻEK

height wysokość	diameter średnica	weight waga
100	50	9
150	65	11
200	80	18
250	95	38
300	110	50
400	150	83
500	170	145
600	200	223
700	230	295
800	265	336
1000	325	650
1200	385	980
1400	450	1400

**MODULAR
STRUCTURE**

**BUDOWA
MODUŁOWA**



Cones are available in heights:
20, 30, 50 ... to 112 m. Dimensions
listed in centimeters, weight in
kilograms. Listed weight does not
include weight of decorations.

Możliwość instalacji stożka o wysokości:
20, 30, 50 ... do 112 m. Wymiary podane
są w centymetrach, waga w kilogramach.
Waga nie obejmuje ciężaru ozdób.

Listed cone heights do not include the LED rope light topper. Add:
50 cm for cones to 6 m, 100 cm for cones to 10 m, 150 cm for cones
to 14 m. i.e. 12 m cone (1200cm in table) will have total height of 13,5 m.

Podane wysokości stożka nie obejmują czubka z węża LED. Do każdej
z nich należy dodać: 50 cm przy stożkach do 6m, 100 cm przy stożkach do
10 m i 150 cm przy stożkach do 14 m. Np. Stożek 12 m (1200 cm w tabeli)
będzie miał końcową wysokość 13,5 m.



DECORATED CHRISTMAS TREES / CHOINKI Z DEKORACJĄ
GIANT CONES / STOŻKI GIGANTY







STD96

-  garland
green spruce
-  tip
model POL617
-  LED lights
warm white,
cool white, FLASH
-  LED rope
cool white
-  mat
gold

STD97

-  garland
green spruce
-  tip
model POL617
-  LED lights
cool white,
FLASH
-  LED rope
cool white

STD98

-  garland
green spruce
-  tip
model POL617
-  LED lights
cool white,
FLASH
-  LED rope
cool white
-  PVC ornaments
golden baubles

CONE / STOŻEK

height wysokość	diameter średnica	weight waga
100	50	9
150	65	11
200	80	18
250	95	38
300	110	50
400	150	83
500	170	145
600	200	223
700	230	295
800	265	336
1000	325	650
1200	385	980
1400	450	1400

**MODULAR
STRUCTURE**

BUDOWA
MODUŁOWA



Cones are available in heights: 20, 30, 50 ... to 112 m. Dimensions listed in centimeters, weight in kilograms. Listed weight does not include weight of decorations.

Możliwość instalacji stożka o wysokości: 20, 30, 50 ... do 112 m. Wymiary podane są w centymetrach, waga w kilogramach. Waga nie obejmuje ciężaru ozdób.

Listed cone heights do not include the LED rope light topper. Add: 50 cm for cones to 6 m, 100 cm for cones to 10 m, 150 cm for cones to 14 m. I.e. 12 m cone (1200cm in table) will have total height of 13,5 m.

Podane wysokości stożka nie obejmują czubka z węża LED. Do każdej z nich należy dodać: 50 cm przy stożkach do 6m, 100 cm przy stożkach do 10 m i 150 cm przy stożkach do 14 m. Np. Stożek 12 m (1200 cm w tabeli) będzie miał końcową wysokość 13,5 m.

**AVAILABLE LED COLOURS
DOSTĘPNE KOLORY LED**

cold white, neutral white, warm white, classic white, yellow, orange, pink, purple, red, blue, water blue, green, multicolor, RGB

biały zimny, biały neutralny, biały ciepły, biały klasyczny, żółty, pomarańczowy, różowy, fioletowy, czerwony, niebieski, niebieski morski, zielony, multikolor, RGB



DECORATED CHRISTMAS TREES / CHOINKI Z DEKORACJĄ

GIANT CONES / STOŻKI GIGANTY

STD08



garland
green spruce



tip
model POL617



LED lights
warm white,
red, FLASH



PVC ornaments
golden baubles



STD09



garland
white spruce



tip
model POL617



LED lights
cool white,
blue, FLASH



PVC ornaments
golden baubles







It is the most popular type of cone. Low-budget (but with effective look, resembling that of more complex models). The time of its production is also important.







Jest to najbardziej popularny wzór stożka. Nisko-budżetowy ale z efektywnym wyglądem stożków bardziej złożonych. Niebagatelne znaczenie ma też szybkość jego wykonania.







STD57

-  garland
green spruce
-  tip
model POL617
-  LED lights
warm white, red, FLASH
-  LED rope
cool white
-  mat
white (silver)

STD58

-  garland
green spruce
-  tip
model POL617
-  LED lights
warm white, red, FLASH
-  LED rope
cool white
-  mat
white (silver)
-  PVC ornaments
golden baubles





STD59

-  garland
świerk red
-  tip
model POL617
-  LED lights
warm white, red, FLASH
-  LED rope
cool white
-  mat
white (silver)

DECORATED CHRISTMAS TREES / CHOINKI Z DEKORACJĄ



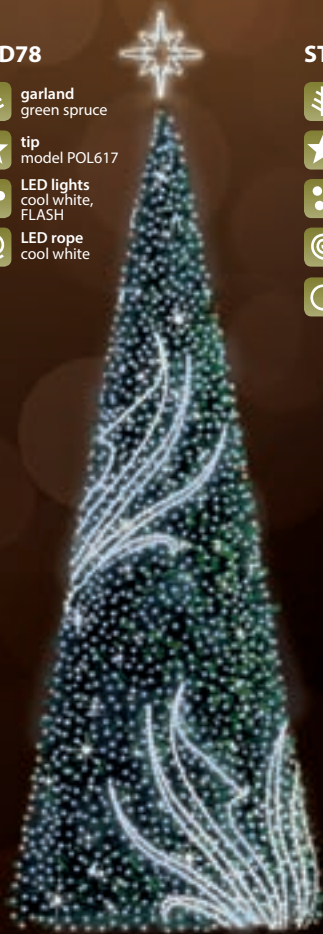

GIANT CONES / STOŻKI GIGANTY

STD78

-  garland green spruce
-  tip model POL617
-  LED lights cool white, FLASH
-  LED rope cool white







STD77

-  garland green spruce
-  tip model POL617
-  LED lights cool white, FLASH
-  LED rope cool white
-  PVC ornaments golden baubles









STD79

-  garland green spruce
-  tip model POL617
-  LED lights cool white, FLASH
-  LED rope warm white
-  PVC ornaments golden baubles





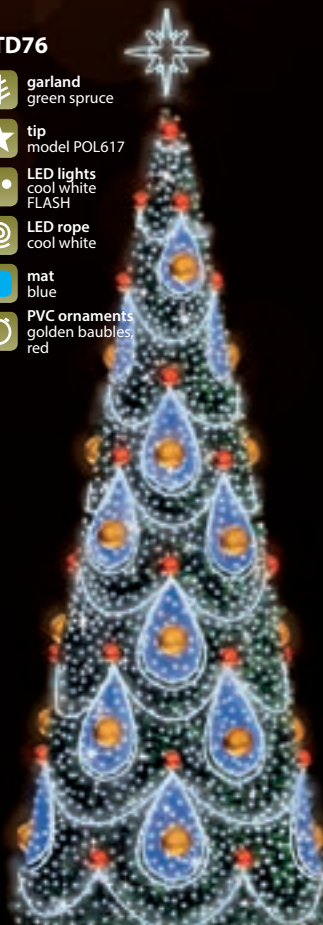

STD76

-  garland green spruce
-  tip model POL617
-  LED lights cool white, FLASH
-  LED rope cool white
-  mat blue
-  PVC ornaments golden baubles, red







STD80

-  garland green spruce, white
-  tip model POL617
-  LED lights cool white, FLASH
-  LED rope cool white



STD81

-  garland green spruce, white
-  tip model POL617
-  LED lights cool white, FLASH, blue
-  LED rope cool white
-  mat blue white





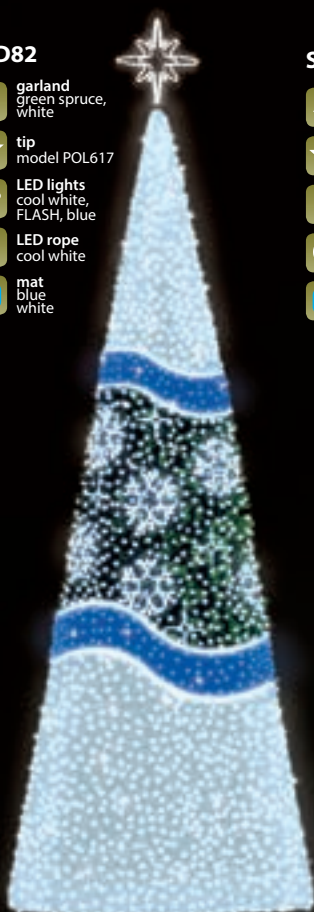

STD82

-  garland green spruce, white
-  tip model POL617
-  LED lights cool white, FLASH, blue
-  LED rope cool white
-  mat blue white



STD83

-  garland green spruce, white
-  tip model POL617
-  LED lights cool white, FLASH, blue
-  LED rope cool white
-  mat blue white



CONE / STOŻEK

height wysokość	diameter średnica	weight waga
100	50	9
150	65	11
200	80	18
250	95	38
300	110	50
400	150	83
500	170	145
600	200	223
700	230	295
800	265	336
1000	325	650
1200	385	980
1400	450	1400

MODULAR STRUCTURE

BUDOWA
MODUŁOWA



Cones are available in heights: 20, 30, 50 ... to 112 m. Dimensions listed in centimeters, weight in kilograms. Listed weight does not include weight of decorations.

Możliwość instalacji stożka o wysokości: 20, 30, 50 ... do 112 m. Wymiary podane są w centymetrach, waga w kilogramach. Waga nie obejmuje ciężaru ozdób.

Listed cone heights do not include the LED rope light topper. Add: 50 cm for cones to 6 m, 100 cm for cones to 10 m, 150 cm for cones to 14 m. I.e. 12 m cone (1200cm in table) will have total height of 13,5 m.

Podane wysokości stożka nie obejmują czubka z węża LED. Do każdej z nich należy dodać: 50 cm przy stożkach do 6m, 100 cm przy stożkach do 10 m i 150 cm przy stożkach do 14 m. Np. Stożek 12 m (1200 cm w tabeli) będzie miał końcową wysokość 13,5 m.

AVAILABLE LED COLOURS DOSTĘPNE KOLORY LED

cold white, neutral white, warm white, classic white, yellow, orange, pink, purple, red, blue, water blue, green, multicolor, RGB

biały zimny, biały neutralny, biały ciepły, biały klasyczny, żółty, pomarańczowy, różowy, fioletowy, czerwony, niebieski, niebieski morski, zielony, multikolor, RGB



Each 2-metre module of a cone is a steel structure coated with anticorrosive layer in the process of galvanisation. The elements can be put one into another, which makes them more convenient to store in the off-season. It is possible to access the inner part of the Christmas tree through a low-profile door in order to install illuminations and do the maintenance.





Każdy z 2-metrowych modułów stożka jest konstrukcją stalową pokrytą powłoką antykorozyjną, powstającą w procesie ocynkowania. Kolejne elementy można schować jeden w drugi, co ułatwia składanie i magazynowanie poza sezonem. Do wnętrza choinki można wejść, dzięki dyskretnym drzwiczkom, pozwalającym na konserwację i montaż oświetlenia.



DECORATED CHRISTMAS TREES / CHOINKI Z DEKORACJĄ





GIANT CONES / STOŻKI GIGANTY

STD41

-  garland green spruce
-  tip model POL617
-  LED lights cool white, blue, FLASH
-  LED rope warm white
-  meteors white







STD42

-  garland green spruce
-  tip model POL617
-  LED lights cool white, blue, FLASH
-  LED rope warm white
-  meteors white









STD43

-  garland green spruce
-  tip model POL617
-  LED lights cool white, FLASH
-  LED rope blue
-  meteors white





STD44

-  garland green spruce
-  tip model POL617
-  LED lights white, white FLASH
-  LED rope blue
-  meteors white
-  PVC ornaments golden baubles







STD48

-  garland green spruce
-  tip model POL617
-  LED lights green, white flash
-  PVC ornaments silver baubles







STD45

-  garland green spruce
-  tip model POL617
-  LED lights warm white, flash red
-  mat red



STD66

-  garland green spruce
-  tip model POL617
-  LED lights warm white, flash red
-  LED rope warm white
-  mat red, gold, silver



AVAILABLE LED COLOURS DOSTĘPNE KOLORY LED







cold white, neutral white, warm white, classic white, yellow, orange, pink, purple, red, blue, water blue, green, multicolor, RGB

biały zimny, biały neutralny, biały ciepły, biały klasyczny, żółty, pomarańczowy, różowy, fioletowy, czerwony, niebieski, niebieski morski, zielony, multikolor, RGB





STD28

-  garland
green spruce
-  tip
model POL617
-  LED lights
white, blue
FLASH
-  LED rope
white
-  meteors
white
-  mat
red



In the case of meteor shower rain lights we can observe the falling light effect.

W przypadku meteorków możemy zaobserwować tzw. „efekt spadającego światła”.

CONE / STOŻEK

height wysokość	diameter średnica	weight waga
100	50	9
150	65	11
200	80	18
250	95	38
300	110	50
400	150	83
500	170	145
600	200	223
700	230	295
800	265	336
1000	325	650
1200	385	980
1400	450	1400

MODULAR STRUCTURE

BUDOWA MODUŁOWA

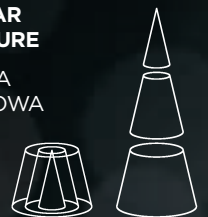

Cones are available in heights: 20, 30, 50 ... to 112 m. Dimensions listed in centimeters, weight in kilograms. Listed weight does not include weight of decorations.

Możliwość instalacji stożka o wysokości: 20, 30, 50 ... do 112 m. Wymiary podane są w centymetrach, waga w kilogramach. Waga nie obejmuje ciężaru ozdób.

Listed cone heights do not include the LED rope light topper. Add: 50 cm for cones to 6 m, 100 cm for cones to 10 m, 150 cm for cones to 14 m. I.e. 12 m cone (1200cm in table) will have total height of 13,5 m.

Podane wysokości stożka nie obejmują czubka z węża LED. Do każdej z nich należy dodać: 50 cm przy stożkach do 6m, 100 cm przy stożkach do 10 m i 150 cm przy stożkach do 14 m. Np. Stożek 12 m (1200 cm w tabeli) będzie miał końcową wysokość 13,5 m.



STD39

-  garland
green spruce
-  tip
model POL617
-  LED lights
green,
FLASH
-  LED rope
cool white
-  PVC ornaments
golden baubles
silver baubles

AVAILABLE LED COLOURS DOSTĘPNE KOLORY LED

cold white, neutral white, warm white,
classic white, yellow, orange, pink, purple,
red, blue, water blue, green, multicolor, RGB

biały zimny, biały neutralny, biały ciepły,
biały klasyczny, żółty, pomarańczowy,
różowy, fioletowy, czerwony, niebieski,
niebieski morski, zielony, multikolor, RGB



Cone blueprints and all necessary statistical and endurance data are available. Ballast base is installed on a level, paved surface, i.e. plazas, town square paving, etc.

Mamy projekty budowlane stożka i wszelkie niezbędne obliczenia statyczne i wytrzymałościowe. Konstrukcja balastowa choinki może być stawiana na otwartej przestrzeni i posadowiona na wypoziomowanym utwardzonym podłożu, typu plac, płyta rynku, etc.



STD27

-  garland
green spruce
-  tip
model POL617
-  LED lights
blue, green
-  PVC ornaments
garland green
stars gold

CONE / STOŻEK

height wysokość	diameter średnica	weight waga
100	50	9
150	65	11
200	80	18
250	95	38
300	110	50
400	150	83
500	170	145
600	200	223
700	230	295
800	265	336
1000	325	650
1200	385	980
1400	450	1400

**MODULAR
STRUCTURE**

**BUDOWA
MODUŁOWA**



Cones are available in heights: 20, 30, 50 ... to 112 m. Dimensions listed in centimeters, weight in kilograms. Listed weight does not include weight of decorations.

Możliwość instalacji stożka o wysokości: 20, 30, 50 ... do 112 m. Wymiary podane są w centymetrach, waga w kilogramach. Waga nie obejmuje ciężaru ozdób.

Listed cone heights do not include the LED rope light topper. Add: 50 cm for cones to 6 m, 100 cm for cones to 10 m, 150 cm for cones to 14 m. I.e. 12 m cone (1200cm in table) will have total height of 13,5 m.

Podane wysokości stożka nie obejmują czubka z węża LED. Do każdej z nich należy dodać: 50 cm przy stożkach do 6m, 100 cm przy stożkach do 10 m i 150 cm przy stożkach do 14 m. Np. Stożek 12 m (1200 cm w tabeli) będzie miał końcową wysokość 13,5 m.

DECORATED CHRISTMAS TREES / CHOINKI Z DEKORACJĄ

GIANT CONES / STOŻKI GIGANTY

STD49

-  garland green spruce
-  tip model POL617
-  LED lights purple, warm white FLASH
-  LED rope warm white
-  PVC ornaments golden baubles, baubles red



STD50

-  garland green spruce
-  tip model POL617
-  LED lights purple, warm white, white FLASH
-  LED rope warm white
-  PVC ornaments golden baubles







STD65

-  garland green spruce
-  tip model POL617
-  LED lights blue, warm white, FLASH
-  LED rope warm white
-  PVC ornaments golden baubles





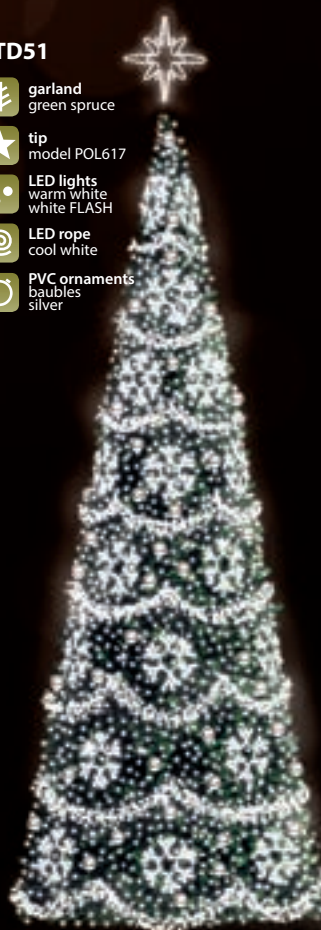

STD51

-  garland green spruce
-  tip model POL617
-  LED lights warm white, white FLASH
-  LED rope cool white
-  PVC ornaments baubles silver







STD72

-  garland green spruce
-  tip model POL617
-  LED lights purple, pink, blue, white FLASH
-  LED rope cool white





STD73

-  garland green spruce
-  tip model POL617
-  LED lights blue, white FLASH
-  LED rope cool white







STD74

-  garland green spruce
-  tip model POL617
-  LED lights green, white FLASH
-  LED rope warm white



STD75

-  garland green spruce
-  tip model POL617
-  LED lights warm white, white FLASH
-  LED rope cool white





STD52

-  **garland**
green spruce
-  **tip**
model POL617
-  **LED lights**
warm white, white FLASH, red
-  **LED rope**
warm white, cool white
-  **PVC ornaments**
red baubles

**AVAILABLE LED COLOURS
DOSTĘPNE KOLORY LED**

cold white, neutral white, warm white, classic white, yellow, orange, pink, purple, red, blue, water blue, green, multicolor, RGB

biały zimny, biały neutralny, biały ciepły, biały klasyczny, żółty, pomarańczowy, różowy, fioletowy, czerwony, niebieski, niebieski morski, zielony, multikolor, RGB



CONE / STOŻEK

height wysokość	diameter średnica	weight waga
100	50	9
150	65	11
200	80	18
250	95	38
300	110	50
400	150	83
500	170	145
600	200	223
700	230	295
800	265	336
1000	325	650
1200	385	980
1400	450	1400

**MODULAR
STRUCTURE**

**BUDOWA
MODUŁOWA**



Cones are available in heights: 20, 30, 50 ... to 112 m. Dimensions listed in centimeters, weight in kilograms. Listed weight does not include weight of decorations.

Możliwość instalacji stożka o wysokości: 20, 30, 50 ... do 112 m. Wymiary podane są w centymetrach, waga w kilogramach. Waga nie obejmuje ciężaru ozdób.

Listed cone heights do not include the LED rope light topper. Add: 50 cm for cones to 6 m, 100 cm for cones to 10 m, 150 cm for cones to 14 m. I.e. 12 m cone (1200cm in table) will have total height of 13,5 m.





Podane wysokości stożka nie obejmują czubka z węża LED. Do każdej z nich należy dodać: 50 cm przy stożkach do 6m, 100 cm przy stożkach do 10 m i 150 cm przy stożkach do 14 m. Np. Stożek 12 m (1200 cm w tabeli) będzie miał końcową wysokość 13,5 m.



DECORATED CHRISTMAS TREES / CHOINKI Z DEKORACJĄ





GIANT CONES / STOŻKI GIGANTY

STD15

-  garland green spruce
-  tip model POL630
-  LED lights white, blue FLASH
-  LED rope cool white
-  PVC ornaments golden baubles red



STD24

-  garland green spruce
-  tip model POL617
-  LED lights cool white, blue
-  LED rope cool white
-  PVC ornaments golden baubles

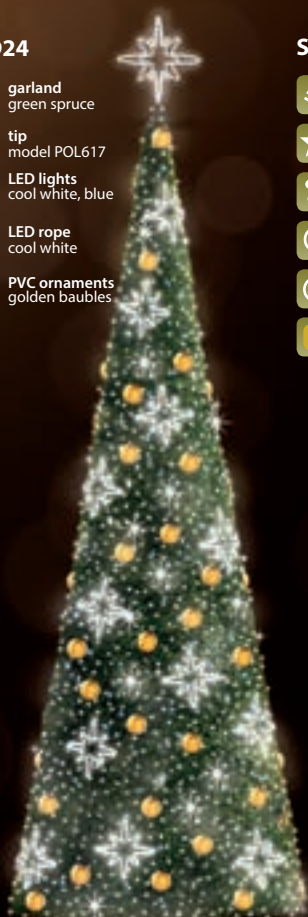





STD64

-  garland green spruce
-  tip model POL617
-  LED lights warm white FLASH
-  LED rope warm white
-  PVC ornaments golden baubles, silver
-  mat gold







STD40

-  garland green spruce
-  tip model POL617
-  LED lights warm white FLASH
-  LED rope warm white, zim.
-  PVC ornaments baubles: gold, red, silver







STD16

-  garland green spruce
-  tip model POL630
-  LED lights white white FLASH
-  LED rope white





STD17

-  garland green spruce
-  tip model POL630
-  LED lights white white FLASH
-  LED rope white, green







STD21

-  garland green spruce
-  tip model POL617
-  LED lights white white FLASH
-  LED rope white



STD62

-  garland green spruce
-  tip model POL629
-  LED lights white white FLASH
-  LED lights purple
-  LED rope white red





CONE / STOŻEK

height wysokość	diameter średnica	weight waga
100	50	9
150	65	11
200	80	18
250	95	38
300	110	50
400	150	83
500	170	145
600	200	223
700	230	295
800	265	336
1000	325	650
1200	385	980
1400	450	1400

MODULAR
STRUCTURE

BUDOWA
MODUŁOWA



Cones are available in heights: 20, 30, 50 ... to 112 m. Dimensions listed in centimeters, weight in kilograms. Listed weight does not include weight of decorations.

Możliwość instalacji stożka o wysokości: 20, 30, 50 ... do 112 m. Wymiary podane są w centymetrach, waga w kilogramach. Waga nie obejmuje ciężaru ozdób.

Listed cone heights do not include the LED rope light topper. Add: 50 cm for cones to 6 m, 100 cm for cones to 10 m, 150 cm for cones to 14 m. I.e. 12 m cone (1200cm in table) will have total height of 13,5 m.

Podane wysokości stożka nie obejmują czubka z węża LED. Do każdej z nich należy dodać: 50 cm przy stożkach do 6m, 100 cm przy stożkach do 10 m i 150 cm przy stożkach do 14 m. Np. Stożek 12 m (1200 cm w tabeli) będzie miał końcową wysokość 13,5 m.





AVAILABLE LED COLOURS
DOSTĘPNE KOLORY LED

cold white, neutral white, warm white, classic white, yellow, orange, pink, purple, red, blue, water blue, green, multicolor, RGB

biały zimny, biały neutralny, biały ciepły, biały klasyczny, żółty, pomarańczowy, różowy, fioletowy, czerwony, niebieski, niebieski morski, zielony, multikolor, RGB



STD18





-  garland
green spruce
-  tip
model POL630
-  LED lights
white
white FLASH
-  LED rope
white
-  PVC ornaments
golden baubles



DECORATED CHRISTMAS TREES / CHOINKI Z DEKORACJĄ

GIANT CONES / STOŻKI GIGANTY

STD05

-  garland green spruce
-  tip model POL617
-  LED lights white white FLASH
-  LED rope white







STD30

-  garland green spruce
-  tip model POL617
-  LED lights white white FLASH
-  meteors white







STD35

-  garland green spruce
-  tip model POL617
-  LED lights white, blue white FLASH
-  LED rope white







STD86

-  garland green spruce
-  tip model POL630
-  LED lights white white FLASH
-  LED rope white
-  PVC ornaments baubles blue







STD31

-  garland green spruce
-  tip model POL630
-  LED lights white white FLASH
-  LED rope white
-  PVC ornaments golden baubles







STD61

-  garland green spruce
-  tip model POL630
-  LED lights white white FLASH
-  LED rope white, green







STD12

-  garland green spruce
-  tip model POL630
-  LED lights white white FLASH
-  LED rope white



STD13

-  garland green spruce
-  tip model POL629
-  LED lights white white FLASH
-  LED rope blue



CONE / STOŻEK

height wysokość	diameter średnica	weight waga
100	50	9
150	65	11
200	80	18
250	95	38
300	110	50
400	150	83
500	170	145
600	200	223
700	230	295
800	265	336
1000	325	650
1200	385	980
1400	450	1400

MODULAR STRUCTURE

BUDOWA MODUŁOWA



Cones are available in heights: 20, 30, 50 ... to 112 m. Dimensions listed in centimeters, weight in kilograms. Listed weight does not include weight of decorations.

Możliwość instalacji stożka o wysokości: 20, 30, 50 ... do 112 m. Wymiary podane są w centymetrach, waga w kilogramach. Waga nie obejmuje ciężaru ozdób.

STD20

- garland
green spruce
- tip
model POL617
- LED lights
white FLASH
- LED rope
white
- meteors
white



Listed cone heights do not include the LED rope light topper. Add: 50 cm for cones to 6 m, 100 cm for cones to 10 m, 150 cm for cones to 14 m. I.e. 12 m cone (1200cm in table) will have total height of 13,5 m.

Podane wysokości stożka nie obejmują czubka z węża LED. Do każdej z nich należy dodać: 50 cm przy stożkach do 6m, 100 cm przy stożkach do 10 m i 150 cm przy stożkach do 14 m. Np. Stożek 12 m (1200 cm w tabeli) będzie miał końcową wysokość 13,5 m.

AVAILABLE LED COLOURS DOSTĘPNE KOLORY LED

cold white, neutral white, warm white, classic white, yellow, orange, pink, purple, red, blue, water blue, green, multicolor, RGB

biały zimny, biały neutralny, biały ciepły, biały klasyczny, żółty, pomarańczowy, różowy, fioletowy, czerwony, niebieski, niebieski morski, zielony, multikolor, RGB



Meteor shower rain lights are to an extent similar to (LED) curtains. They are used as outside illuminations. LEDs are hung on a string and resemble meteor shower rain. Subtle but effective cool white light. Strings with LEDs can have 20 or 50 cm, having 240 LEDs, or 100 cm with 640 sources of light. Since they are used to decorate building elevations, windows or roofs they are splash-proof. These high-quality products have very long lifespan (100000h), great damage resistance, and UV resistance. 230V power supply, 7,9, 9,6W power. Sets of meteor shower rain LED lights can be joined together up to 10 sets. They can be connected with a patented connecting piece. The falling light effect attracts attention of passers-by.

Meteorki to produkt pokrewny kurtynom i kurtynkom LED. Są przeznaczone do tworzenia iluminacji w przestrzeni zewnętrznej. Podobnie, jak wymienione produkty, mają sznur, z którego w dół puszczane są diody LED świecące, jak spadające meteory. Subtelne, ale efektowne światło w kolorze zimnej bieli. Długości sznurów z LED to 20, 50, mające 240 diod lub 100 cm z 640 źródłami światła. Jako produkt do zdobienia elewacji, okien, czy dachów, są bryzgoszczelne. Mają bardzo wysoką jakość, a zatem i żywotność (100000 godzin świecenia), ponadto bardzo wysoka odporność na uszkodzenia i promieniowanie UV. Zasilanie 230V a moc 2,4 oraz 7,9 i 9,6W. Zestaw meteorków LED zachowujący kompatybilność powinien liczyć maksymalnie 10 kompletów. Łączy się je opatentowaną złączką. Efekt spadającego światła bez wątpienia przyciąga uwagę przechodniów.



DECORATED CHRISTMAS TREES / CHOINKI Z DEKORACJĄ

GIANT CONES / STOŻKI GIGANTY





AVAILABLE LED COLOURS DOSTĘPNE KOLORY LED

cold white, neutral white, warm white, classic white, yellow, orange, pink, purple, red, blue, water blue, green, multicolor, RGB

biały zimny, biały neutralny, biały ciepły, biały klasyczny, żółty, pomarańczowy, różowy, fioletowy, czerwony, niebieski, niebieski morski, zielony, multikolor, RGB





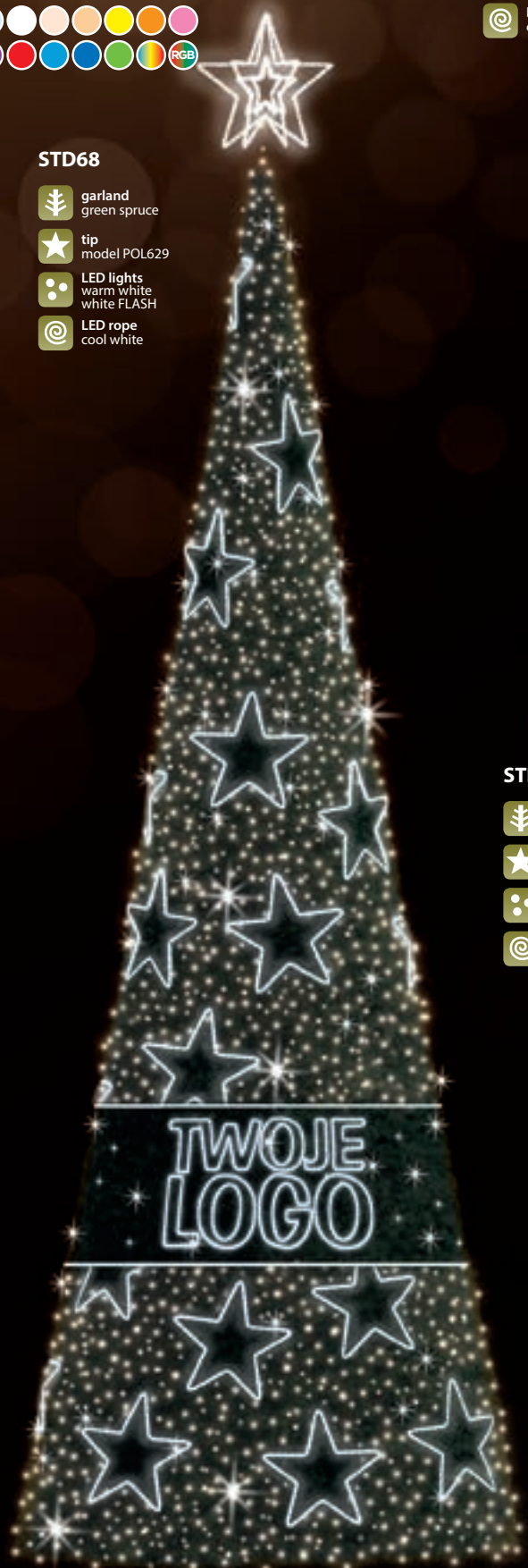

STD68

-  garland
green spruce
-  tip
model POL629
-  LED lights
warm white
white FLASH
-  LED rope
cool white







STD67

-  garland
green spruce
-  tip
model POL629
-  LED lights
warm white
white FLASH
-  LED rope
cool white



STD22

-  garland
green spruce
-  tip
model POL617
-  LED lights
white, red, blue
white FLASH
-  LED rope
white







STD69

-  garland
green spruce
-  tip
model POL629
-  LED lights
warm white
white FLASH
-  LED rope
cool white



STD70

-  garland
green spruce
-  tip
model POL617
-  LED lights
cool white,
FLASH, red
-  LED rope
cool white
-  mat
red



STD60

-  garland
green spruce
-  tip
model POL617
-  moduły RGB

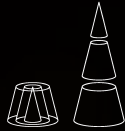

height wysokość	diameter średnica	weight waga
100	50	9
150	65	11
200	80	18
250	95	38
300	110	50
400	150	83
500	170	145
600	200	223
700	230	295
800	265	336
1000	325	650
1200	385	980
1400	450	1400

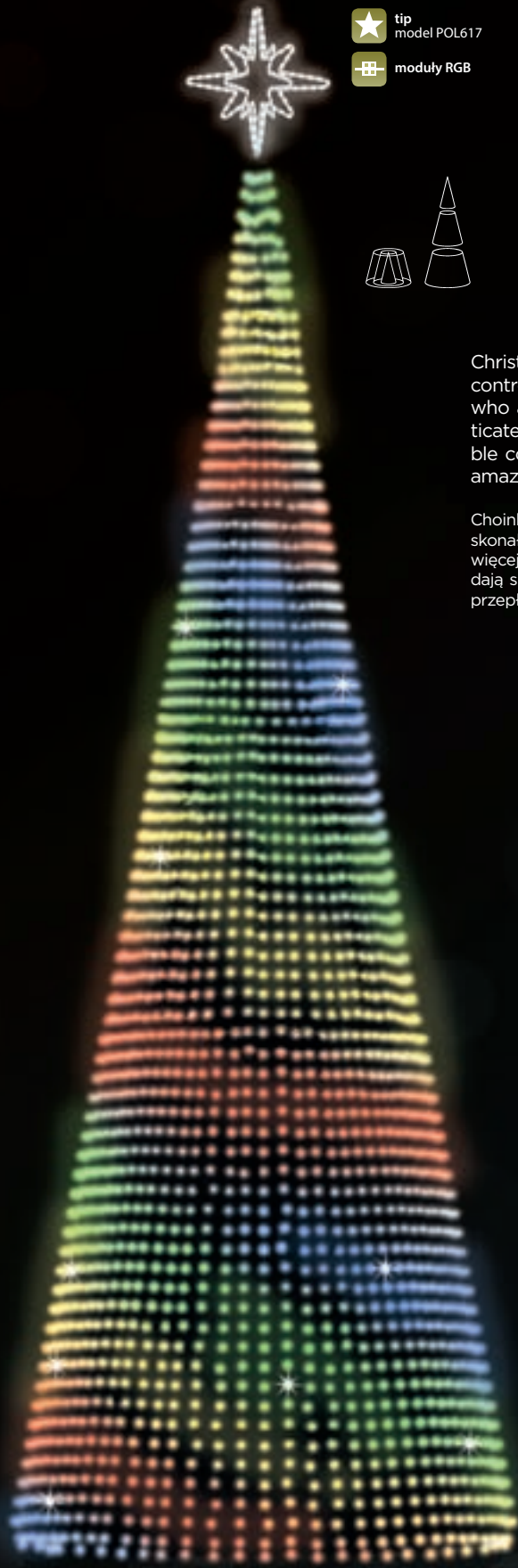

Christmas trees with LED RGB modules and control panel are a perfect product for those who are looking for something more sophisticated than static light decor. The controllable colour and flow of light which they offer, amazingly livens up any display.

Choinki z modułami LED RGB i sterownikiem to doskonała propozycja dla osób oczekujących czegoś więcej niż statyczne dekoracje świetlne. Idealnie nadają się do ożywienia dekoracji poprzez sterowanie przepływem światła i kolorów.

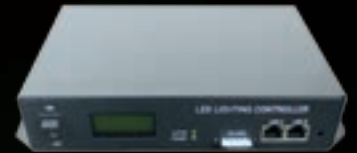

Remote controlled
for convenience

Wygodne sterowanie pilotem.

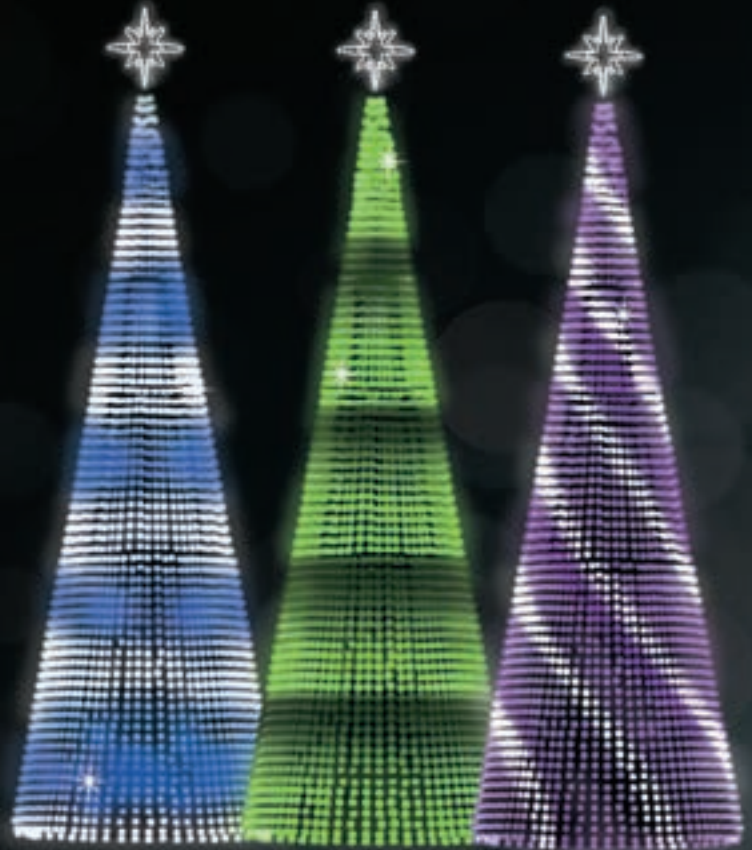





Cones are available in heights: 20, 30, 50 ... to 112 m. Dimensions listed in centimeters , weight in kilograms. Listed weight does not include weight of decorations.

DECORATED CHRISTMAS TREES / CHOINKI Z DEKORACJĄ





GIANT CONES WITH PASSAGE / STOŻKI GIGANTY Z PRZEJŚCIEM

STD40P

-  garland green spruce
-  tip model POL617
-  LED lights warm white, white FLASH
-  LED rope white, warm white
-  PVC ornaments baubles: gold, red, silver







STD81P

-  garland green spruce
-  tip model POL617
-  LED lights cool white, FLASH, blue
-  LED rope cool white
-  mat blue, white







STD39P

-  garland green spruce
-  tip model POL617
-  LED lights green, white FLASH
-  LED rope white
-  PVC ornaments golden baubles, silver baubles







STD73P

-  garland green spruce
-  tip model POL617
-  LED lights blue, white FLASH
-  LED rope cool white







STD89P

-  garland green spruce
-  tip model POL617
-  LED lights warm white, FLASH
-  LED rope cool white







STD90P

-  garland green spruce
-  tip model POL617
-  LED lights cool white, FLASH
-  LED rope cool white
-  PVC ornaments golden baubles







STD95P

-  garland green spruce
-  tip model POL617
-  LED lights warm white, FLASH, red
-  LED rope warm white
-  mat gold
-  PVC ornaments golden baubles



STD79P

-  garland green spruce
-  tip model POL617
-  LED lights cool white, FLASH
-  LED rope warm white
-  PVC ornaments golden baubles



CONE WITH PASSAGE

height	diam.	weight
600	200	223
700	230	295
800	265	336

**MODULAR
STRUCTURE**

BUDOWA
MODUŁOWA



The listed heights do not include a LED rope light tree topper. 50 cm and 100 cm have to be added to the given height of cones up to 6 m and 8 m respectively.

Podane wysokości stożka nie obejmują czubka z węża LED. Do każdej z nich należy dodać: 50 cm przy stożkach do 6m, 100 cm przy stożkach do 8 m.

Walk-through trees are a new product in our offer. Thanks to the tunnel leading through their base, they aren't restricted to areas free from pedestrian traffic and may be situated on sidewalks and walkways. For aesthetic purposes, tunnels are available in trees of at least 6 meters high or taller. Standard models are listed below.

Choinki z przejściem do nowości w naszej ofercie. Dzięki przejściu mogą stać nie tylko w odizolowanych od pieszych miejscach ale także na chodnikach i skwerach. Ze względów estetycznych oferujemy przejścia dla stożków 6 m i 8 m.



**AVAILABLE LED COLOURS
DOSTĘPNE KOLORY LED**

cold white, neutral white, warm white, classic white, yellow, orange, pink, purple, red, blue, water blue, green, multicolor, RGB

biały zimny, biały neutralny, biały ciepły, biały klasyczny, żółty, pomarańczowy, różowy, fioletowy, czerwony, niebieski, niebieski morski, zielony, multikolor, RGB



DECORATED CHRISTMAS TREES / CHOINKI Z DEKORACJĄ

VICTORIA - A GIANT CHRISTMAS TREE WITH A NATURAL LOOK

VICTORIA - CHOINKA GIGANT O NATURALNYM WYGLĄDZIE

Victoria is a giant Christmas tree with a number of appearance. In contrast to the cone Victoria built is from the main trunk and attached to it separate branches. This design resembles natural tree and allows you to attach decorations not only on the surface as on a cone, but also deep in the body tree. Recommended decorations are baubles, LED lights, bows and PVC stars.

Victoria to choinka typu gigant o naturalnym wyglądzie. W przeciwieństwie do stożka choinka Victoria zbudowana jest z głównego pnia i mocowanych do niego osobnych gałęziach. Taka konstrukcja przypomina naturalne drzewo i pozwala mocować dekoracje nie tylko na powierzchni jak na stożku ale także w głębi bryły drzewa. Polecane dekoracje to bombki, lampki LED, kokardy i gwiazdy PCV.

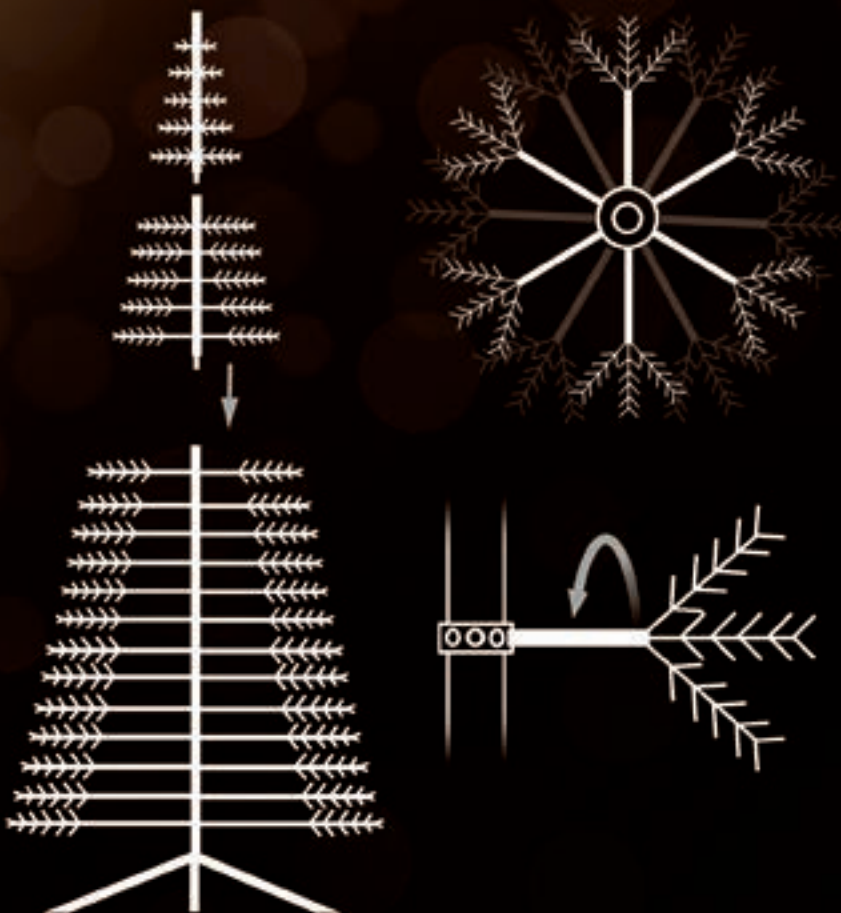

VICTORIA

name nazwa	height wysokość	diameter średnica	weight waga
V300	300	180	50
V400	400	220	120
V500	500	260	180
V600	600	320	260
V700	700	350	390
V800	800	380	540
V1000	1000	450	930

We produce Victoria up to a height of 10m. Bigger Christmas trees are delivered to order. Because other type of surface use a light hose is limited to small elements.

Victorię produkujemy do wysokości 10m. Większe choinki dostarczamy na zamówienie. Ze względu na inny rodzaj powierzchni stosowanie węża świetlnego jest ograniczone do niewielkich elementów.

DECORATED CHRISTMAS TREES / CHOINKI Z DEKORACJĄ

VICTORIA - A GIANT CHRISTMAS TREE WITH A NATURAL LOOK

VICTORIA - CHOINKA GIGANT O NATURALNYM WYGLĄDZIE

As in traditional cones, it is possible to mount the tip of the star in the right proportions.

Tak jak w tradycyjnych stożkach istnieje możliwość zamontowania czubka z gwiazdy w odpowiednich proporcjach.



AVAILABLE LED COLOURS / DOSTĘPNE KOLORY LED

cold white, neutral white, warm white, classic white, yellow, orange, pink, purple, red, blue, water blue, green, multicolor, RGB

biały zimny, biały neutralny, biały ciepły, biały klasyczny, żółty, pomarańczowy, różowy, fioletowy, czerwony, niebieski, niebieski morski, zielony, multikolor, RGB



CHRISTMAS TREES / CHOINKI

TYPES / RODZAJE



POLAMP LLC has been producing conifer needles and Christmas mats since 2009. The components used in the process of production are of the highest quality. They are characterised by their resistance to UV radiation. All our decorations made from conifer needles not easily ignitable. We produce Christmas trees, garlands, wreaths, spheres, and tinsel from our conifer needles. Years of observations and experience have led to professional, safe, and convenient solutions.

POLAMP Sp. z o.o. od roku 2009 wytwarza igliwie i maty świąteczne. Komponenty używane do ich produkcji są najwyższej jakości. Charakteryzują się odpornością na promienie UV. Wszystkie dekoracje z igliwia są trudno zapalne. Z naszego igliwia produkujemy choinki, girlandy, wianki, kule oraz lamety. Lata obserwacji i doświadczenia zaowocowały profesjonalnymi, bezpiecznymi i łatwymi rozwiązaniami.

Giant Christmas trees

Unlike standard Christmas trees they can reach up to 112 m of height. It is possible thanks to a modular construction which is durable and easy to transport. Christmas trees of this type are used in the case of large city areas, sport and entertainment halls, shopping centres, and city centres.

Choinki GIGANTY

W odróżnieniu od zwykłych choinek mogą osiągać wysokość do 112 m. Umożliwia to specjalna modułowa konstrukcja, która jest wytrzymała i łatwa w transporcie. Zastosowanie tego typu choinek to przede wszystkim duże przestrzenie miejskie, hale widowiskowo-sportowe, galerie, centra miast.

The basic models of giant Christmas trees are cones and pyramids. We produce them from steel profiles and then we coat them with an anti-corrosive layer. Later on the structure is covered with green, white or red PVC conifer needles. Giant Christmas trees are composed of 2-metre segments which are put one on another. The foundation is designed to fit on a standard pallet. For the time of storage or transport the elements can be put one into another. For the purposes of maintenance or installation of lighting, the cone is equipped with an "invisible" door covered with conifer needles, through which the interior of the cone can be accessed.

Podstawowymi modelami choinek wielkogabarytowych są stożek i piramida. Produkujemy je z profili stalowych, a następnie zabezpieczamy powłoką antykorozyjną. Następnie konstrukcja jest powlekana igliwem z PCV w kolorze zielonym, białym lub czerwonym. Giganty dzielą się na 2 m segmenty, które są nakładane jeden na drugi. Podstawa jest tak skonstruowana, aby zmieściła się na zwykłej palecie. Na czas przechowywania bądź transportu elementy stożka można schować jeden w drugim. Do środka choinki prowadzą drzwiczki, które wypełnione są igliwem i wtapiają się w choinkę czyniąc je „niewidzialnymi”. Ułatwia to nam konserwację i montaż oświetlenia we wnętrzu stożka.

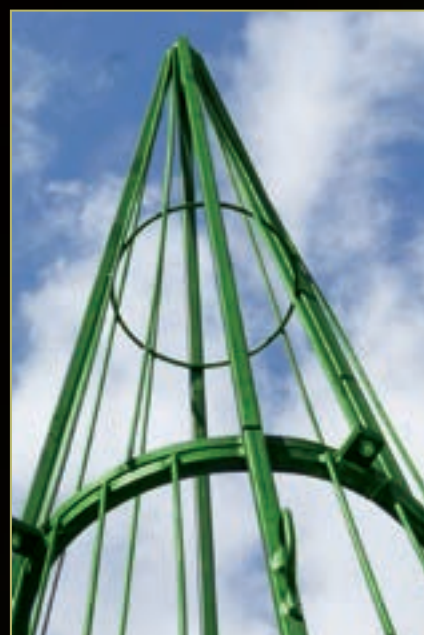
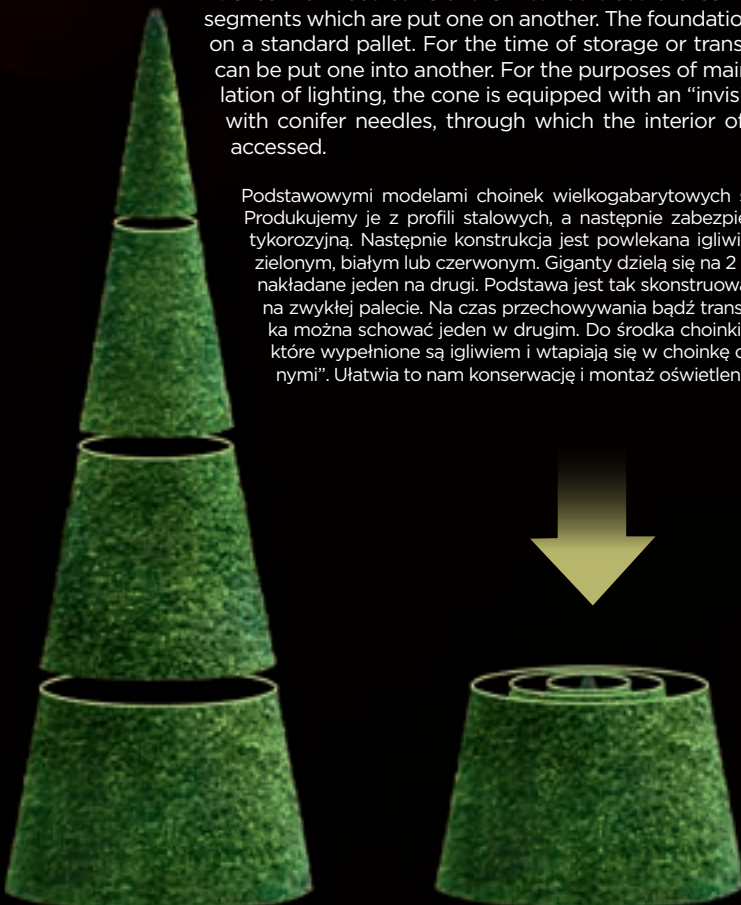

CHRISTMAS TREES / CHOINKI

MIG/MAG WELDING TECHNOLOGY / SPAWANIE, CYNKOWANIE, RODZAJE IGLIWIWA

MIG/MAG welding technology

The structures of Christmas trees and fountains are welded with the use of MIG/MAG technology (Metal Inert Gas / Metal Active Gas) - welding with a fusible electrode in an inert gas atmosphere (MIG, method 131) or in an active gas atmosphere (MAG, method 145). Inert gases such as argon and helium are used in the majority of cases, whereas as for active gases - carbon dioxide or its mixture with argon.

In the case of MIG/MAG method, an electric arc glows between the welded material and the electrode (wire). The arc and liquid metal are protected by a stream of an inert or an active gas. This method is perfect for welding the majority of materials - the thing is to select an adequate electrode wires for different metals.

Spawanie MIG/MAG

Konstrukcje choinek i fontann spawane są metodą MIG/MAG (ang. Metal Inert Gas / Metal Active Gas) - spawanie elektrodą topliwą w osłonie gazów obojętnych (MIG, metoda 131) lub aktywnych (MAG, metoda 135). Jako gazy osłonowe obojętne najczęściej stosuje się argon lub hel. Natomiast jako gazy osłonowe aktywne - dwutlenek węgla lub jego mieszaninę z argonem.

W metodzie MIG/MAG łuk elektryczny jarzy się między spawanym materiałem a elektrodą w postaci drutu. Łuk i jeziorko ciekłego metalu są chronione strumieniem gazu obojętnego lub aktywnego. Metoda nadaje się do spawania większości materiałów, dobierając druty elektrodowe odpowiednie dla różnych metali.



Galvanisation

The aim of galvanisation is to coat the surface of steel objects with a thin layer of zinc so as to protect it against corrosion caused by air and water. We use hot-dip galvanisation - dipping an object in a zinc bath.

The zinc layer is a few times more resistant to corrosion than steel which was not galvanised. It is because the standard electrode potential of zinc is more electronegative than the potential of iron. Zinc will corrode in the first place and the products of its corrosion will slow down further corrosion. As a result, our structures for cones and decorations can be exposed to negative atmospheric conditions for a few years.

Cynkowanie

Cynkowanie ma na celu pokrycie powierzchni przedmiotów stalowych cienką powłoką cynku w celu ochrony przed korozją powodowaną działaniem powietrza i wody. Stosujemy głównie cynkowanie zanurzeniowe (ogniowe) - zanurzenie przedmiotu w ciekłej kąpeli cynkowej.

Powłoka cynkowa wykazuje w warunkach miejskiego środowiska korozyjnego od kilku do kilkunastu razy większą odporność korozyjną od stali nie cynkowanej. Dzieje się tak dlatego, że potencjał standardowy cynku jest znacznie bardziej elektroujemny niż potencjał żelaza. W pierwszej kolejności będzie korodował cynk, a produkty jego korozji będą spowalniać dalszą korozję. Dzięki temu nasze konstrukcje do stożków i dekoracji mogą być wystawione na niekorzystne warunki atmosferyczne przez kilka lat.

Complement elements / Elementy uzupełniające

In our offer we have foundations for Christmas trees, platforms, and railings. On customer's request we can put a logo or a name of company, city, sponsor, etc.

W swojej ofercie posiadamy gotowe fundamenty do choinek, podesty oraz plotki. Na życzenie klienta możemy dowolnie nanieść logo lub nazwę firmy, miasta, sponsora itp.



Colour and type of conifer needles / Kolor i rodzaj igliwiwa

The basic colour is green and the basic type of conifer needles is spruce. On customer's request, i.e., white, silver, and black colours are available. The conifer needles can also resemble pine, fir, and larch.

Podstawowym kolorem jest zieleń, a rodzajem igliwiwa świerk. Na życzenie klienta dostępne są również kolory m.in.: biały, srebrny, czarny. Igliwie również może przypominać sosnę, jodłę, modrzew.



CHRISTMAS TREES / CHOINKI

CONSTRUCTION OF THE CONE / BUDOWA STOŻKA

An exemplary scheme of a giant 14-metre Christmas tree
 Przykładowy schemat choinki wielkogabarytowej 14 m.

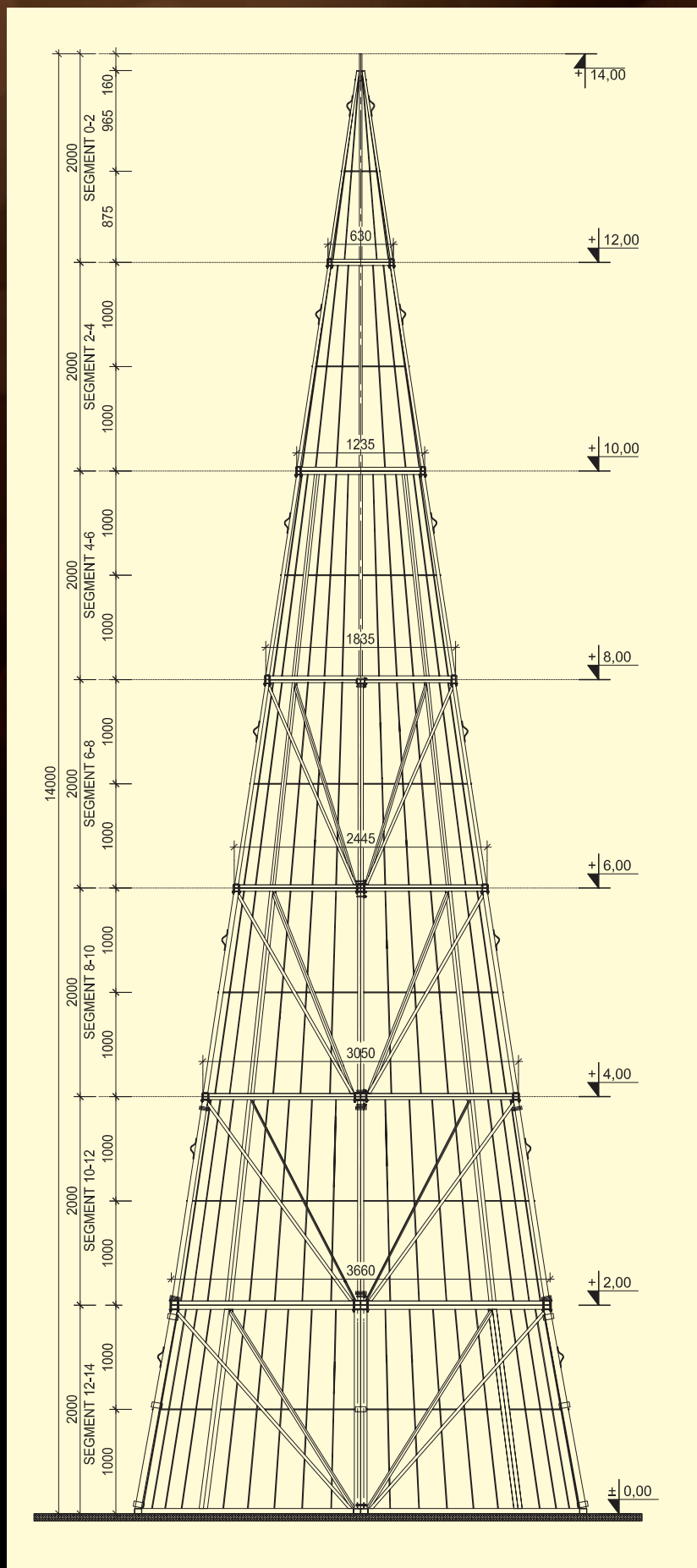

Static and durability calculations.

The scheme shows the structure of a 14-metre steel Christmas tree. It was treated as a spatial steel structure and all welded bonds were treated as stiff. The calculations were made with Robot Structural Analysis 2010 software. Spatial model of the structure is depicted in the pictures below. Dead weight of structural elements was calculated automatically. The same wind load (in accordance with PN-77/B-02011 Az1) as in the case of a cylindrical structure because of a tight coating with conifer needles.

Obliczenia statyczne i wytrzymałościowe

Do projektu budowlanego typowej konstrukcji choinki stalowej, wysokości 14 m. Choinkę obliczono jako przestrzenną konstrukcję stalową. Wszystkie połączenia spawane przyjęto sztywne. Obliczenia przeprowadzono w programie Robot Structural Analysis 2010. Model przestrzenny konstrukcji przedstawiono na poniższych rysunkach. Ciężar własny elementów konstrukcyjnych przyjęty automatycznie. Obciążenie wiatrem (wg PN-77/B-02011 Az1) jak dla konstrukcji walcowej, z uwagi na szczelne pokrycie igliwem.

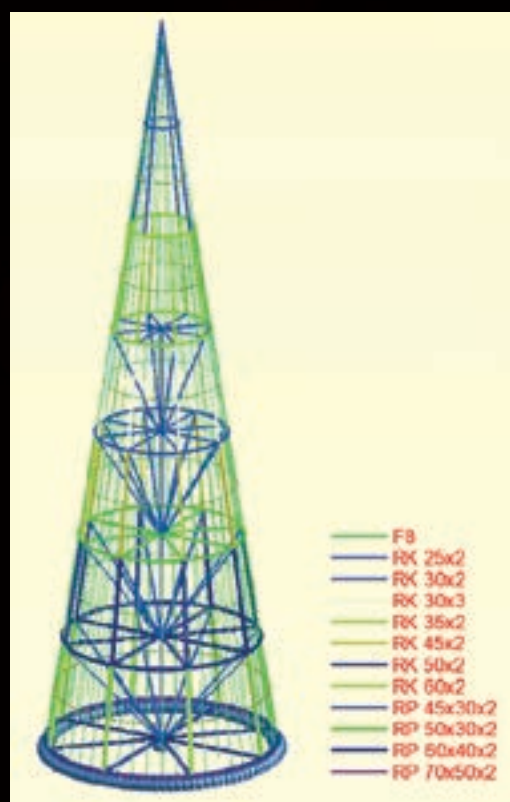

Ballast installation scheme Schemat montażu balastu

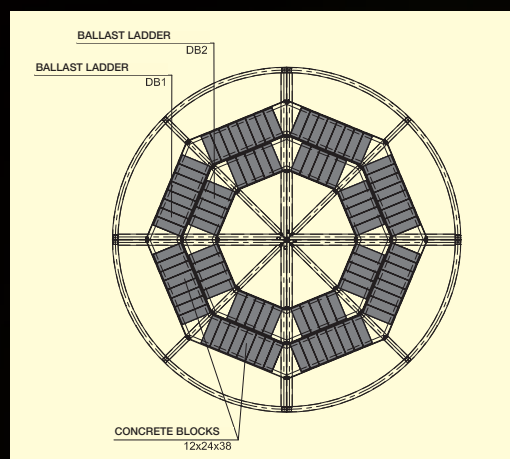

Exemplary elements of a 14-metre cone with section of the lowest part.
Przykładowe segmenty stożka 14m wraz z dolnym przekrojem.

Cone's segment 0-2 / segment stożka 0-2

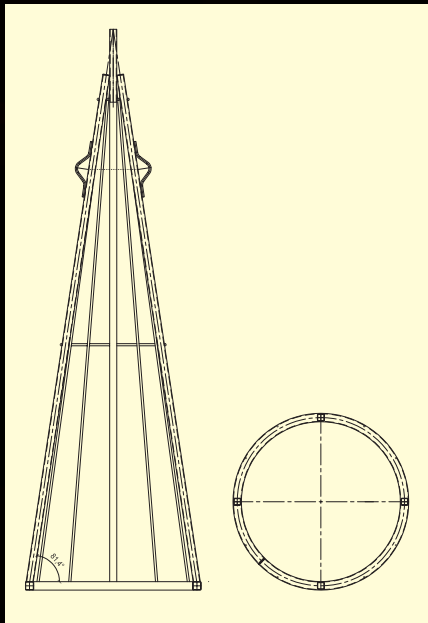

Cone's segment 8-10 / segment stożka 8-10

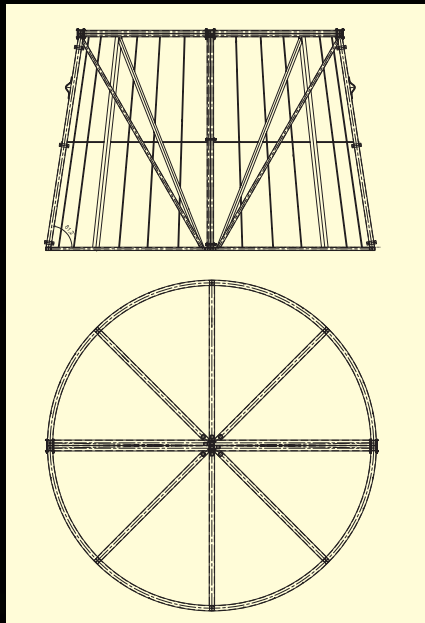

Cone's segment 12-14 / segment stożka 12-14

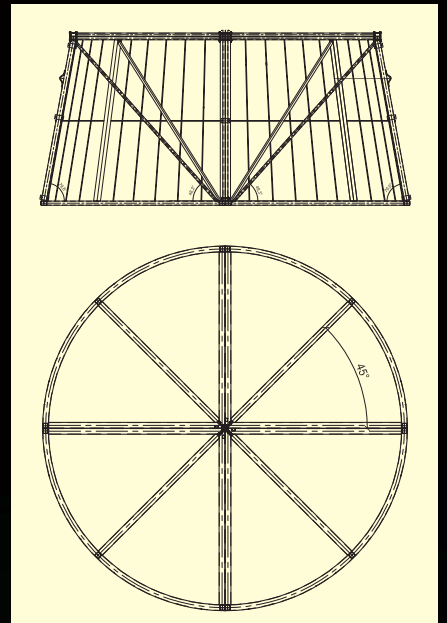

Detailed description of elements of a selected segment (12-14) / Szczegółowy opis elementów wybranego segmentu (12-14)

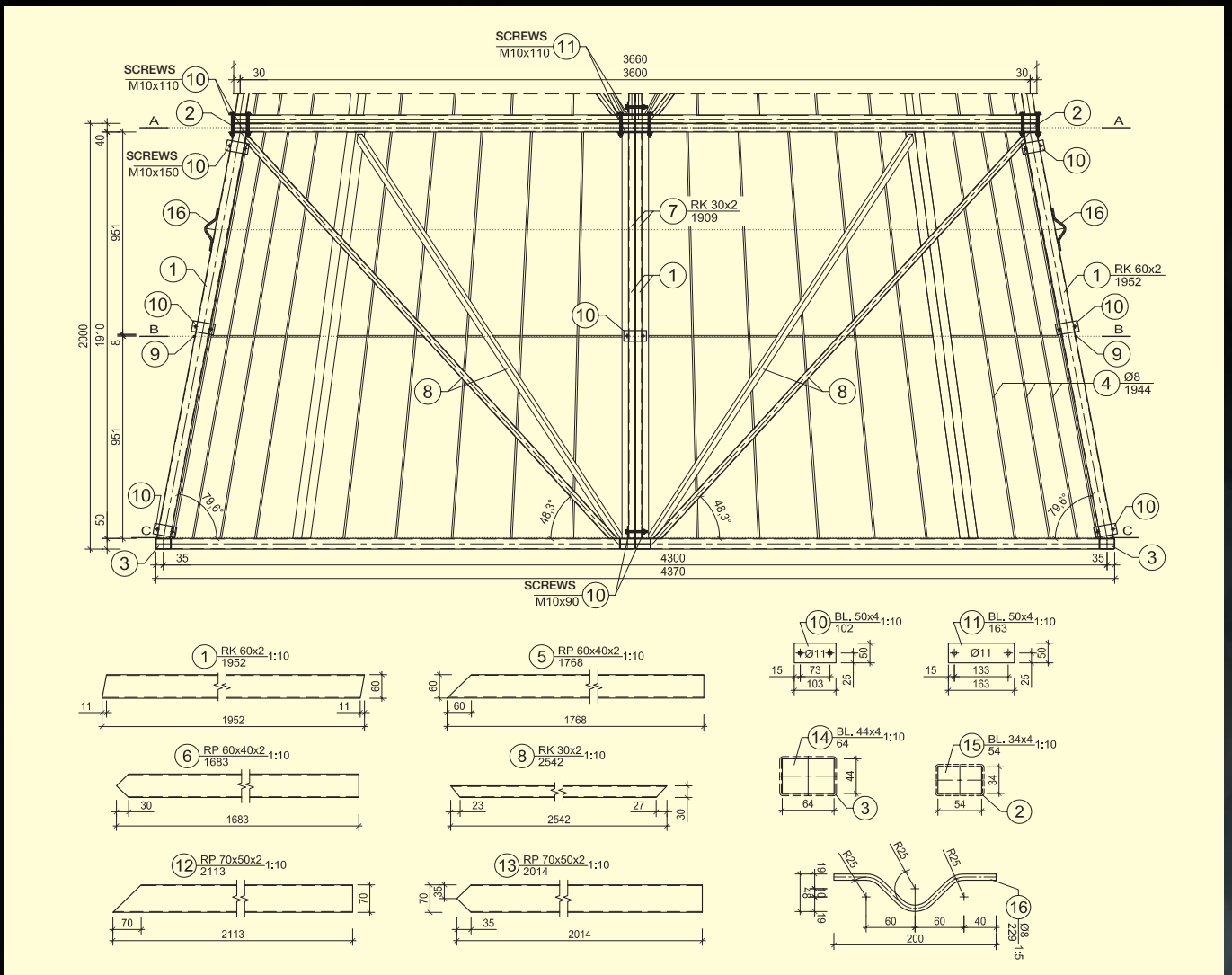

CHRISTMAS TREES / CHOINKI

LIGHT AND PVC DECORATIONS / DEKORACJE ŚWIETLNE I Z PCV

We also offer complete and decorated Christmas trees in different size - small ones to set in an office or in a house, as well as giant ones to set outside. We use a variety of ornaments from our offer to decorate Christmas trees. These ornaments are predominately LED lights, LED rope lights, meteor shower rain lights, as well as PVC ornaments like baubles in different size, stars, figures, etc. Below we present an exemplary Christmas tree and a description of the elements it is composed of.

Nasza oferta to także gotowe ozdobione choinki. Zarówno te mniejsze do biur i domów jak i choinki giganty do stosowania na zewnątrz. Do zdobienia choinek używamy szeregu ozdób znajdujących się także w naszej ofercie. Są to głównie dekoracje świetlne jak lampki LED, węże świetlne LED, meteorki, a także ozdoby z PCV jak bombki o różnych rozmiarach, gwiazdki, figurki itp. Poniżej prezentujemy przykładową choinkę i opis elementów z których jest zbudowana.



LED rope lights

An important element of light decoration. Thanks to the fact that LED lights are put inside a special rope we get the effect of solid lines of light. The rope light is perfect for forming different shapes.

Węże świetlne LED

Ważny element dekoracji świetlnej. Dzięki umieszczeniu lampek LED w specjalnym wężu otrzymujemy efekt ciągłego światła w postaci linii świetlnych. Doskonale nadaje się do pokazywania kształtów.



Controller

Controllers are perfect for making the decoration seem more vivid by controlling the flow of light in lights, meteor shower rain lights, and rope lights. Controllers provide a great variety of effects.

Sterownik

Sterowniki idealnie nadają się do ożywienia dekoracji poprzez sterowanie przepływem światła w lampkach, meteorkach i wężach. Zapewniają dużą różnorodność uzyskiwanych efektów.



PVC ornaments

Baubles in various sizes, colours and with different layers are basic decorative elements.

Dekoracje z PCV

Podstawowym elementem dekoracyjnym są bombki o różnych rozmiarach, kolorach i powłokach.



Colourful mats

Colourful mats intensify the brightness of a decoration and bring out its colour by reflecting the light.

Kolorowe maty

Kolorowe maty odbijają światło potęgują jasność dekoracji i mocniej podkreślają kolor.



MUSIC

What is new in our offer is the possibility to add popular Christmas melodies to be played by the Christmas tree.

Muzyka

Nowością w naszej ofercie jest możliwość dodania do choinki muzyki w postaci popularnych świątecznych melodii.



LED modules / Moduły LED



Strobe light / Lampa stroboskopowa



Tip of a Christmas tree

It is predominately a light decoration in the form of a star or a spatial snowflake.

Czubek choinki. Jest to przeważnie dekoracja świetlna w formie gwiazdy lub śnieżynki przestrzennej.

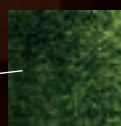

Christmas tree-cone, garland - spruce.

It is a basic element of a Christmas tree, which is attached directly to the metal structure in the shape of a cone. Cones with additional branches that make the Christmas tree seem more natural are new in our offer.

Choinka-stożek z zielonej girlandy typu świerk. Jest to podstawowy element choinki umieszczany bezpośrednio na metalowej konstrukcji w kształcie stożka. Nowością są stożki z dodatkowymi gałązkami, które sprawiają, że choinka wygląda na bardziej naturalną.



LED string lights

A basic element of light decoration. The lights can be used in low temperatures and when humidity is high. Thanks to the use of LEDs the lights are characterised by scant emission of heat. The strings have a patented connecting piece at the end, which

allows the connection of up to 10 sets powered by one cord.

Lampki LED

Podstawowa forma dekoracji świetlnej. Lampki można stosować w niskich temperaturach i przy dużej wilgotności powietrza. Poprzez zastosowanie technologii LED dają one znikomą emisję ciepła. Sznurki zakończone są opatentowaną złączką co pozwala na łatwe i szybkie połączenia do 10 zestawów na jednym kablu zasilającym.



Flash LEDs

LEDs with FLASH effect complement standard lights and thanks to the flashing effect they attract attention.

Lampki LED FLASH

Lampki LED z efektem FLASH stanowią uzupełnienie standardowych lampek i dzięki efektowi migania zwracają uwagę na całą dekorację.



RGB LED string lights

have plastic encasement. They come in RGB colour - it is a LED which is capable of glowing with three primary colours (red, green, blue), thus capable of glowing with any colour thanks to the possibility to combine these colours. A controller and a remote control included.

Lampki LED RGB

Występują w kolorze RGB LED - jest to dioda mająca struktury do generowania trzech podstawowych barw (czerwony, zielony, niebieski), a co za tym idzie, przez możliwość ich mieszania, praktycznie dowolnej barwy. W zestawie programator i pilot do sterowania efektami świetlnymi.



Meteor shower rain lights

In the case of meteor shower rain lights we can observe the falling light effect, which is a stunning view.

Meteorki

W przypadku meteorków możemy zaobserwować tzw. „efekt spadającego światła”.

We can also use coloured LED light bulbs or strobe lights as decorative elements of a Christmas tree.

Dodatkowo jako elementy dekoracyjne choinki możemy użyć żarówek stroboskopowych lub żarówek kolorowych LED.

Phases of decoration of a Christmas tree / Fazy dekorowania choinki



1

Welding of the cone's structure and coating with anticorrosive. Attachment of spruce conifer needles to the cone's structure.

Zespawanie konstrukcji stożka i zabezpieczenie jej przed korozją. Przytwierdzenie sztucznego igliwia świerkowego do konstrukcji stożka.



2

Attachment of LED, flash LED, RGB or ball lights. Optimal number of lights in proportion to the height of a Christmas tree is shown in the table on page 56.

Nalożenie lampek świetlnych w postaci lampek LED, LASH, RGB lub lampek kulek. Optymalne użycie lampek w stosunku do wielkości choinki pokazane jest w tabeli (str. 56).



3

Attachment of illuminations in the form of white (or in other colour) snowflakes composed of LED rope light or its standard variant.

Nalożenie dekoracji świetlnych w formie białych lub w innym kolorze śnieżynek z węża led lub węża żarówkowego.



4

Attachment of PVC ornaments, baubles, tip in the form of a spatial star composed of LED rope light.

Nalożenie dekoracji z PCV w postaci bombek. Zaczipienie czubka choinki z węża LED w postaci przestrzennej gwiazdy.

Rope light decorations / Dekoracje świetlne z węża

These are predominately stars and snowflakes. See pages 174-175. Arranged appropriately, they can also be used to decorate the tip of a Christmas tree. We usually use POL-0001 or POL-0002 ornaments for this purpose. The tip can also be decorated with other ornaments.

Najczęściej są to gwiazdki i śnieżyńki. Patrz str. 174-175. Odpowiednio ułożone mogą zdobić również czubek choinki. Standardowo wykorzystujemy do tego ozdoby POL-0001 lub POL-0002. Istnieje możliwość instalacji czubka z innych ozdób.

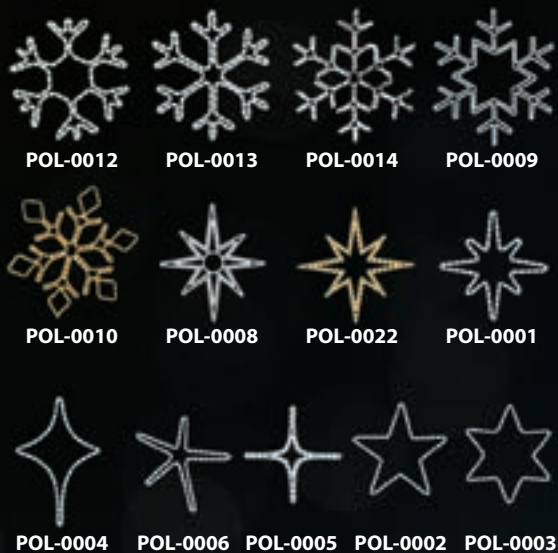

POL-0617

POL-0629

POL-0630



tip on cross plan, composed of 2 ornaments
czubek na planie krzyża z 2 ozdób



tip on six-pointed star plan, composed of 3 ornaments
czubek na planie gwiazdy sześcioramiennej z 3 ozdób



tip on eight-pointed star plan, composed of 4 ornaments
czubek na planie gwiazdy ośmioramiennej z 4 ozdób



CHRISTMAS TREES / CHOINKI

TYPES AND THE NUMBER OF LIGHTS / ILOŚĆ OŚWIETLENIA I RODZAJE LAMPEK

The number of lights / Ilość oświetlenia

What will come in handy is our table which provides approximate minimum and maximum number of sources of light. Tu pomocna okaże się nam nasza ściągawka, która w przybliżeniu określa minima i maksima punktów świetlnych.

Name Nazwa	The number of parts or chests Ilość skrzyń lub części	Approximate lateral area m ² Szacowane pole powierzchni bocznej m ²	STANDARD		EXCLUSIVE	
			LED lighting – minimal number of sources of light Oświetlenie LED ilość punkt. świetl. min.	Number of cords Ilość sznurów	LED lighting – optimal number of sources of light Oświetlenie LED ilość punkt. świetlnych	Number of cords Ilość sznurów
SPRUCE CONES / STOŻKI ŚWIERKOWE						
ST100S	1	0,81	100	1	200	2
ST150S	2	1,57	200	2	300	3
ST200S	2	2,56	300	3	400	4
ST250S	3	4,00	400	4	600	6
ST300S	3	5,51	600	6	900	9
ST400S	2	9,58	1 000	10	1 600	16
ST500S	3	14,36	1 500	15	2 400	24
ST600S	3	21,07	2 200	22	3 600	36
ST700S	4	26,76	2 600	26	4 500	45
ST800S	5	30,48	3 200	32	5 200	52
ST900S	5	41,51	4 200	42	7 200	72
ST1000S	7	50,88	4 200	42	8 800	88
ST1200S	10	86,26	8 800	88	14 400	144
ST1400S	13	124,29	13 000	130	21 000	210
SPRUCE PYRAMIDS / PIRAMIDY ŚWIERKOWE						
P100	1	0,90	100	1	200	2
P150	2	1,80	200	2	300	3
P200	2	3,00	400	4	500	5
P250	3	4,50	600	6	800	8
P300	3	6,30	800	8	1 100	11
P400	2	10,40	1 200	12	1 800	18
P500	3	15,50	1 800	18	2 700	27
P600	3	21,60	2 800	28	3 600	36
P700	4	29,40	3 400	34	5 000	50
P800	5	38,40	4 600	46	6 600	66
P1000	5	56,00	6 600	66	9 600	96
P1200	7	81,60	9 600	96	14 000	140
P1400	10	96,20	11 500	115	16 400	164

Colours of lighting

Kolory oświetlenia

cold white
biały zimny

neutral white
biały neutralny

warm white
biały ciepły

classic white
biały klasyczny

yellow
żółty

pink
różowy

purple
fioletowy

red
czerwony

orange
pomarańczowy

blue
niebieski

water blue
niebieski morski

green
zielony

multi colour
multikolor

Types of lights / Rodzaje lampek

There are 11 basic colours of lights, which are often LED lights. We offer standard LED lights, ball lights, and RGB lights in the case of which each LED can glow with any RGB colour.

Lampki występują w 11 podstawowych kolorach. Najczęściej jest to źródło światła LED. W naszej ofercie posiadamy standardowe lampki LED jak też lampki kulki czy lampki RGB, gdzie każda dioda może świecić dowolnym kolorem z palety RGB.



CHRISTMAS TREES / CHOINKI
TYPES OF PVC ORNAMENTS / RODZAJE OZDÓB Z PCV

BAUBLES ON A STRING / BOMBKI NA SZNURZE

10 m string, baubles - 8 cm, golden, silver, red
 10 m sznur, bombki - 8 cm złote, srebrne, czerwone



SINGLE BAUBLES / BOMBKI POJEDYNCZE

Single baubles: white, silver, golden, red, blue - from 100 to 300 mm
 bombki pojedyncze: białe, srebrne, złote, czerwone, niebieskie o średnicy od 100 do 300 mm



STARS / GWIAZDY

14 x 15 cm; 19 x 20 cm,
 silver, golden, red
 srebrne, złote, czerwone

PVC BOWS / KOKARDY Z PCV

Custom colours, shape, and dimensions
 kolory, kształt i wymiary na zamówienie



POLYSTYRENE FOAM SNOWFLAKES 110 cm

STYROPIANOWE ŚNIEŻYNKI 110 cm



METALLISED MATS / MATY MEATLIZOWANE

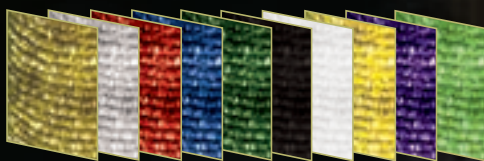

POL-FOLSTAR1M PET optical film
FOLIA OPTYCZNA POL-FOLSTAR1M
 Stars effect, the film is available in the form
 of a reel (20 m x 1 m) or single A4 sheets.
 Efekt gwiazdek, dostępna w rolce 20m x 1m
 jak w pojedynczych arkuszach A4

A basic type of PVC ornaments in our offer is bauble. We offer silver, golden, red, white, and blue baubles in different size - from 100 to 300 mm. The baubles, just like other PVC ornaments, are weather-proof and can withstand mechanical damage. 8 cm golden, silver, and red baubles on a 10 m string are new in our offer.

Podstawowym rodzajem ozdoby PCV w naszej ofercie jest bombka. Posiadamy bombki w wersji srebrnej, złotej, czerwonej, białej i niebieskiej w rozmiarach od 100 mm do 300 mm. Bombki podobnie jak pozostałe ozdoby z tworzywa sztucznego odporne są na warunki atmosferyczne i działania mechaniczne. Nowością w naszej ofercie są 10 metrowe sznury z bombek 8 cm w kolorze złotym, srebrnym i czerwonym.



CHRISTMAS TREES / CHOINKI

ASSEMBLY OF THE CONE / SPOSÓB MONTAŻU STOŻKA

All cones, regardless of their size, are composed of one or a few segments. It facilitates the assembly, the disassembly, and the transport. We put effort to make sure that the ornaments are arranged in a natural way and that the whole resembles one element after assembly.

Wszystkie stożki niezależnie od rozmiaru składają się z jednego lub kilku segmentów. Ułatwia to montaż, demontaż i transport. Jednocześnie dbamy o to by rozmieszczenie elementów dekoracyjnych było naturalne a całość po zmontowaniu wyglądała jak jeden element.



The majority of our cones is fully-assembled in a factory. We put complete decorations on each segment (lights, baubles, rope lights) so as to save time and make the final installation faster. During the transport the cone is again disassembled into segments. As a result, all the disassembled segments require the same space as the biggest one.

Większość naszych stożków montowana jest w całości jeszcze w fabryce. Na każdy segment stożka nałożona zostaje kompletna dekoracja (lampki, bombki, węża) tak by skrócić czas instalacji na miejscu. Na czas transportu stożek ponownie jest dzielony na segmenty i zajmuje tyle miejsca ile największy dolny segment.

After the segments are assembled in the right order and the lighting cords are connected, the cone is ready.

Na miejscu wystarczy tylko ułożyć w odpowiedniej kolejności poszczególne segmenty, połączyć przewody oświetlenia i stożek jest gotowy do użycia.

Before the cone is shipped, each segment's functionality is checked - the lighting and the way segments fit together.

Zanim stożek wyruszy w drogę sprawdzana jest funkcjonalność każdego segmentu - oświetlenie i dopasowanie połączeń między segmentami.



In the evening and during the night the cone's beautiful illumination can be admired. All its elements are weather-proof.

Wieczorem i w nocy możemy podziwiać przepiękną iluminację stożka. Wszystkie jego elementy odporne są na warunki pogodowe takie jak deszcz i śnieg.



The time required to assemble or disassemble the whole cone is reduced thanks to the segmental structure and the installation of lighting and PVC ornaments in the case of each segment. The cone can be transported in a light commercial vehicle.

Dzięki segmentowej budowie i montażu oświetlenia i ozdób PCV na poszczególnych częściach stożka skraca się czas instalacji i demontażu całości. Dodatkowo transport stożka może odbywać się za pomocą średniej wielkości samochodów dostawczych.

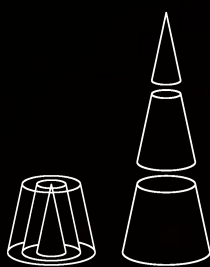

Stages of the cone's preparation in the factory and its installation in the target place.
Kolejne fazy przygotowania stożka w fabryce i montowania w miejscu docelowym.



CHRISTMAS TREES / CHOINKI
EXAMPLE CONE DURING NIGHTTIME
PRZYKŁADOWY STOŻEK NOCA



CHRISTMAS TREES / CHOINKI

WITH REMOTE CONTROL FOR LIGHTS, CURTAINS, AND METEOR LIGHTS
Z PILOTEM DO LAMPEK, KURTYN I METEORKÓW



Music
Muzyka

Flashing
Błyskanie

Twinkling
Miganie

Fading
Przygasanie

Pulsating
Pulsowanie

In waves
Falowanie

RGB changing colour
Zmiana koloru
RGB

Controllers are an ideal option for people who expect something more than just static light decorations. They are perfect to make the whole decoration seem more vivid thanks to the possibility of controlling the flow of light in the case of lights, curtains, meteor shower rain lights, etc. They provide a great variety of effects and the possibility to create own modes in a system with one or more controllers. We also offer controllers both for single decorations and the whole systems of lighting which can be controlled with a remote control.

We offer devices with built-in radio control modules using Zig-Bee protocol to control illuminations in the case of streets, squares, parks, and buildings.

Sterowniki zwane też programatorami to doskonała propozycja dla osób oczekujących czegoś więcej niż statyczne dekoracje świetlne. Idealnie nadają się do ożywienia dekoracji poprzez sterowanie przepływem światła w lampkach, kurtynach, meteorkach itp. Zapewniają dużą różnorodność uzyskiwanych efektów oraz możliwość tworzenia całych scenariuszy sterowania w układach jedno- i wielo-sterownikowych. W ofercie posiadamy sterowniki zarówno do pojedynczych dekoracji jak i dla całych systemów oświetlenia ze zdalnym sterowaniem.

Do sterowania iluminacjami na rozległym obszarze oferujemy urządzenia z wbudowanymi modułami komunikacji radiowej wg protokołu Zig- Bee. Umożliwiają one budowę spójnie zarządzanych systemów iluminacji na obszarach ulic, placów, parków, budowli.

Table of example modes with a scheme of jumpers setting in the controller.
Tabela przykładowych programów wraz ze schematem ustawienia zworek w sterowniku.

S1 DIP_SW	Mode number Nr progr. z konfig.	AS-OU2 producer's mode program producenta
5 6 7 8		
OFF OFF OFF OFF	1	All off / wyłącz wszystko
OFF OFF OFF ON	2	twinkling-change/ migotanie-przełącz
OFF OFF ON OFF	3	twinkling on/off / migotanie wł./wyl.
OFF OFF ON ON	4	light up/fade out 1,2 / rozpal/wygaś 1,2
OFF ON OFF OFF	5	light up 1,2 – fade out 1,2 / rozpal 1,2 - wygaś 1,2
OFF ON OFF ON	6	light up/fade out channel 1, channel 2 flashing / kanał 1 rozpal/wygaś, kanał 2 rozbłyski
OFF ON ON OFF	7	light up/fade out variable rate / rozpal/wygaś zmienne tempo
OFF ON ON ON	8	switch twinkling variable rate / migotanie przełącz zmienne tempo
ON OFF OFF OFF	9	twinkling on/off variable rate / migotanie wł./wyl. zmienne tempo
ON OFF OFF ON	10	twinkling variable brightness / migotanie zmienny poziom jasności
ON OFF ON OFF	11	light up/fade out 1,2 ½ cycle change / rozpal/wygaś 1,2 przesunięcie 1/2 cyklu
ON OFF ON ON	12	light up/fade out 1,2 ¼ cycle change / rozpal/wygaś 1,2 przesunięcie 1/4 cyklu
ON ON OFF OFF	13	reserve (fade out everything) / rezerwa (wygaś wszystko)

Convenient control with a remote control even in the case of a large city area.

Wygodne sterowanie pilotem nawet na dużym obszarze miejskim.

Producer's modes or easily-created own modes.

Do wyboru scenariusze sterowania producenta lub prosta możliwość przygotowania własnej aranżacji!

GARLANDS AND SMALL XMAS TREES

GIRLANDY I MAŁE CHOINKI

GARLANDS W/O ORNAMENTS / RODZAJE GIRLAND BEZ DEKORACJI



SPRUCE GARLAND THICK
GIRLANDA ŚWIERKOWA GĘSTA
TG3111-9 22 x 270 cm
UV resistant / odporna na UV



SPRUCE GARLAND THICK
GIRLANDA ŚWIERKOWA GĘSTA
TG3111-2 22 x 270 cm



SPRUCE GARLAND THICK
GIRLANDA ŚWIERKOWA GĘSTA
TG3111-12 35 x 270 cm
odporna na UV / odporna na UV



WHITE SPRUCE GARLAND THICK
GIRLANDA ŚWIERKOWA GĘSTA BIAŁA
TG3111-8 22 x 270 cm
UV resistant / odporna na UV

SPRUCE GARLAND CANDY STYLE
GIRLANDA ŚWIERKOWA TYPU CUKIEREK
X2716T050 90 x 20 cm



SPRUCE WREATH
WIANEK ŚWIERKOWY
X2716T041 45 cm

CHRISTMAS TREE PREMIUM
W/ METAL STAND
CHOINKA PREMIUM
z metalowym stojakiem
CT3111-6 Ø120 x 220 cm

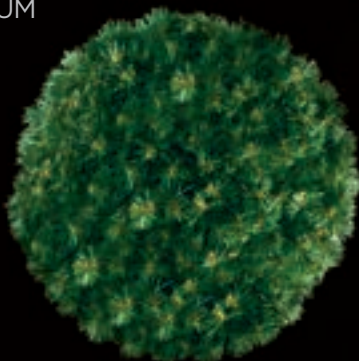

SPRUCE SPHERE
KULE ŚWIERKOWE

KU 30	green zielona	ø 30 cm
KU 40	green zielona	ø 40 cm
KU 50	green zielona	ø 50 cm
KU 60	green zielona	ø 60 cm
KU 70	green zielona	ø 70 cm
KU 80	green zielona	ø 80 cm
KU 90	green zielona	ø 90 cm
KU 110	green zielona	ø 110 cm

Not unlike our trees, these garlands are made of artificial, weather-proof needles. Available needle styles are spruce and pine. Available in classic green, white or red colour. Suggestions listed on this page are merely our standard models. Custom garlands available on request.

Podobnie jak choinki girlandy zbudowane są ze sztucznego igliwia odpornego na warunki atmosferyczne. Podstawowym rodzajem igliwia jest świerk w kolorze zielonym. Dostępne są również girlandy sosnowe. Inne dostępne kolory to biel i czerwień. Proponowane obok kształty to podstawowe wzory. Na specjalne zamówienie realizujemy inne rozwiązania.

ORNAMENTS: PVC, STYROFOAM AND WOOD
OZDOBY Z PCV, STYROPIANU I DREWNA
FOR SMALL XMAS TREES, GARLANDS / DO MAŁYCH CHOINEK I GIRLAND

BAUBLES ON WIRE / BOMBKI NA SZNURZE

10m wire, baubles - 8cm gold, silver, red
 10 m sznur, bombki - 8 cm złote, srebrne, czerwone



SD-WY002 80 G

SD-WY002 80 S

SD-WY002 80 R

STYROFOAM SNOWFLAKE
 w/ gleam
STYROPIANOWA ŚNIEŻYNKA
 z połyskiem
SD-WYS024 110 cm



SINGLE BAUBLES / BOMBKI POJEDYNCZE

white, silver, gold, red, blue/ białe, srebrne, złote, czerwone, niebieskie **POL-AY-B**



POL AY-B108-W	white / biała	Ø60mm
POL AY-B108-S	silver / srebrna	Ø60mm
POL AY-B108-G	golden / złota	Ø60mm
POL AY-B108-R	red / czerwona	Ø60mm
POL AY-B108-B	blue / niebieska	Ø60mm
POL AY-B109-W	white / biała	Ø80mm
POL AY-B109-S	silver / srebrna	Ø80mm
POL AY-B109-G	golden / złota	Ø80mm
POL AY-B109-R	red / czerwona	Ø80mm
POL AY-B109-B	blue / niebieska	Ø80mm
POL AY-B110-W	white / biała	Ø100mm
POL AY-B110-S	silver / srebrna	Ø100mm
POL AY-B110-G	golden / złota	Ø100mm
POL AY-B110-R	red / czerwona	Ø100mm
POL AY-B110-B	blue / niebieska	Ø100mm
POL AY-B111-W	white / biała	Ø120mm
POL AY-B111-S	silver / srebrna	Ø120mm
POL AY-B111-G	golden / złota	Ø120mm
POL AY-B111-R	red / czerwona	Ø120mm
POL AY-B111-B	blue / niebieska	Ø120mm
POL AY-B112-W	white / biała	Ø150mm
POL AY-B112-S	silver / srebrna	Ø150mm
POL AY-B112-G	golden / złota	Ø150mm
POL AY-B112-R	red / czerwona	Ø150mm
POL AY-B112-B	blue / niebieska	Ø150mm
POL AY-B113-W	white / biała	Ø200mm
POL AY-B113-S	silver / srebrna	Ø200mm
POL AY-B113-G	golden / złota	Ø200mm
POL AY-B113-R	red / czerwona	Ø200mm
POL AY-B113-B	blue / niebieska	Ø200mm
POL AY-B114-W	white / biała	Ø250mm
POL AY-B114-S	silver / srebrna	Ø250mm
POL AY-B114-G	golden / złota	Ø250mm
POL AY-B114-R	red / czerwona	Ø250mm
POL AY-B114-B	blue / niebieska	Ø250mm
POL AY-B115-W	white / biała	Ø300mm
POL AY-B115-S	silver / srebrna	Ø300mm
POL AY-B115-G	golden / złota	Ø300mm
POL AY-B115-R	red / czerwona	Ø300mm
POL AY-B115-B	blue / niebieska	Ø300mm

NOTE: additional colours and sizes available on request
 UWAGA: inne kolory i wymiary na zamówienie

STARS / GWIAZDY

SD-WHY040 14 x15 cm; 19 x 20 cm
 silver, golden, red/ srebrna, złta, czerwona



PVC BOWS
KOKARDY Z PCV
 colours and sizes on request



WOOD ORNAMENTS
DREWNIANE ORNAMENTY
POL-DROR
 7 styles, 250 pieces set

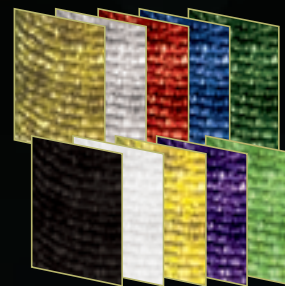

METALIZED MATS
MATY METALIZOWANE

AY-01-W - white / biała
AY-01-R - red / czerwona
AY-01-B - blue / niebieska
AY-01-GR - green (not metallic) **zielona (matowa)**
AY-01-GR-2 - green / zielona
AY-01-G - golden złota
AY-01-S - silver / srebrna
AY-01-BL - black / czarna
AY-01-Y - yellow / żółta
AY-01-PU - purple / fioletowa
 roll 1x20 m



OPTICAL FOIL / FOLIA OPTYCZNA
POL-FOLSTAR 1M

Star effect, available in 20m x 1m rolls or single A4 sheets the foil, used together with LED lights, diffuses the LED light throughout the entire surface of the sheet.

Efekt gwiazdek, dostępna w rolce 20m x 1m jak w pojedynczych arkuszach A4 Folia przy wykorzystaniu odbłasku światła LED rozprasza je na całą swoją powierzchnię.

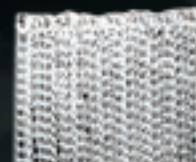

PVC NET TRANSPARENT 1x1m
SIATKA PVC TRANSPARENTNA 1x1m
POL-NETPVC-T

SMALL XMAS TREES, DECORATED
CHOINKI MAŁE Z DEKORACJĄ

CHRISTMAS TREES, WREATHS, GARLANDS W/ DECORATION

CHOINKI, WIANKI, GIRLANDY Z DEKORACJĄ



XMAS TREE **X2687-050**
225 cm, 180 baubles / bombek



XMAS TREE **X2687-051**
225 cm, 180 baubles / bombek



XMAS TREE **X2687-047**
225 cm, 180 baubles / bombek



XMAS TREE **X2687-048**
225 cm, 180 baubles / bombek



Wreath **X2687-050-1**
60 cm, 58 baubles / bombek



Wreath **X2687-051-1**
60 cm, 58 baubles / bombek



Wreath **X2687-047-1**
60 cm, 58 baubles / bombek



Wreath **X2687-048-1**
60 cm, 58 baubles / bombek

**SMALL XMAS TREES, DECORATED
CHOINKI MAŁE Z DEKORACJĄ**

**XMAS TREE GOLDEN DREAMS
CHOINKA GOLDEN DREAMS**

X2716 E065
225 cm
200 assorted
ornaments



**GARLAND
GIRLANDA**

X2716 E069
270 x 25 cm



**MOON
KSIĘŻYC**
X2716 E071
75 x 30 cm



**WREATH
WIANEK**
X2716 E072
60 cm



**XMAS TREE FAMILY TIES
CHOINKA FAMILY TIES**

X2716 G044
225 cm
200 different
decorations



**GARLAND
GIRLANDA**

X2716 G048
270 x 25 cm



**MOON
KSIĘŻYC**
X2716 G050
75 x 30 cm



**Wreath
WIANEK**
X2716 G051
60 cm



NOTE: Xmas Trees, wreaths and garlands do not include LED lights, which are sold separately.

UWAGA: choinki, wianki i girlandy są dostarczane bez oświetlenia LED, które jest dostępne osobno.

GARLANDS, DECORATED / GIRLANDY Z DEKORACJĄ
CHANDELIER W/ GARLAND, STARS, OVER-THE-STREET DECOR
ŻYRANDOL, PRZEWIESZKA, MEDALIONY, GWIAZDY

POL-0950G
 200x125 cm
 LED15W



Our garland enhanced decorations look great both day and night. They are a perfect complement to Christmas trees and over-the-street and facade decorations.

Dodanie girlandy do naszych ozdób sprawiło że dekoracje nabierają gęstości i wyglądają dobrze zarówno w nocy jak i w dzień. Są doskonałym uzupełnieniem choinek, ozdób wiszących nad ulicami i na elewacjach.

POL-0960G
 60 cm
 LED30W / LED50W



POL-0965G
 50x300 cm
 LED20W



POL-0966G
 120x540 cm
 LED100W

POL-1996G
 100 cm
 LED5W



POL-0961G
 100 cm
 LED5W



POL-0962G
 100 cm
 LED5W



POL-0963G
 100 cm
 LED5W



POL-0964G
 110 cm
 LED5W



POL-1997G
 100 cm
 LED5W





POL-1970G
150X150 cm
LED25W



POL-1971G
150X150 cm
LED25W



POL-1972G
150X150 cm
LED25W



POL-1991G
150X150 cm
LED75W



POL-1992G
150X150 cm
LED71W



POL-1993G
150X150 cm
LED53W



POL-1994G
150X150 cm
LED25W

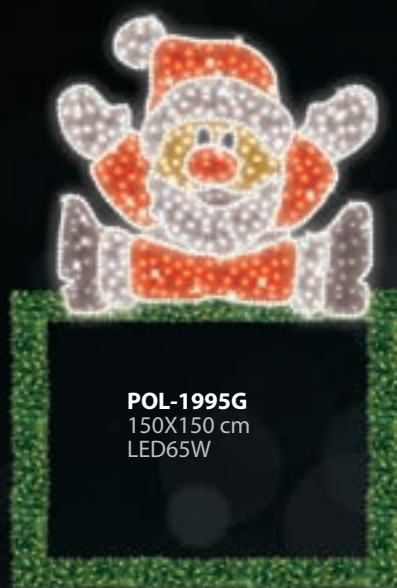

POL-1995G
150X150 cm
LED65W

FIGURES, 3D ANIMATED / FIGURY ANIMOWANE 3D SETS / ZESTAWY

Animated life-size figures are a perfect complement to light decorations and Christmas trees. Both individual figures and figure sets are available.

Animowane figury naturalnej wielkości to doskonałe uzupełnienie dekoracji świetlnych i choinek. Dostępne są zarówno pojedyncze egzemplarze jak i całe zestawy.



set **POLPU-001** figure height 80-180 cm



set **POLPU-002** figure height 100-175 cm



set **POLPU-003** figure height 80-185 cm



set **POLPU-004** figure height 100-150 cm



set **POLPU-005** nativity scene dimensions 250 x 350 cm set **POLPU-006** figure height 70 cm



set **POLPU-007** figure height 70-220 cm



set **POLPU-008** figure height 80-120 cm

Example of a finished
market booth

Przykładowy gotowy
domek jarmarkowy



XMAS MARKETS ORGANIZATION Organizacja jarmarków świątecznych

No time of the year is more suited for a street market with selection of locally made products than Christmas.

Weihnachtsmarkt (from German Weihnacht – Christmas), a traditional Christmas street market held in many towns in Germany, Austria and Switzerland, is becoming more popular outside those countries as well. Weihnachtsmarkt is traditionally held on the streets or squares in town's historic district. Shopping malls now often join in the custom by organizing similar events too. An attractively decorated and illuminated market attracts customers who are looking for unique items and wholesome food of high quality – products which are especially sought-after in Christmas time.

Święta to doskonały czas na organizację jarmarków z ofertą produktów regionalnych. Weihnachtsmarkt (od niem. Weihnacht Boże Narodzenie) – tradycyjny jarmark bożonarodzeniowy, odbywający się w plenerze w wielu miastach Niemiec, Austrii, Szwajcarii zdobywa coraz większą popularność w Polsce. Typowy jarmark odbywa się na ulicach lub placach starszych części miast. Coraz częściej galerie handlowe decydują się na urozmaicenie oferty świątecznej takim właśnie jarmarkiem. Efektownie zdobiona i oświetlona impreza przyciąga klientów, którzy świadomie poszukują oryginalnych przedmiotów oraz zdrowej, wysokiej jakości żywności. Są to produkty pożądane zwłaszcza w okresie około świątecznym.



DECORATIONS - COLLECTIONS
 DEKORACJE - KOLEKCJE
 COLLECTION 31

The collections presented below are sets of well-chosen universal, lamp post, street, and building decorations. These examples may be helpful to create own collections.

Prezentowane poniżej kolekcje to zestawy odpowiednio dobranych dekoracji uniwersalnych, latarniowych, ulicznych i elewacyjnych. Przykłady te mogą być pomocne w tworzeniu własnych kolekcji.



POL-1905M



POL-0941M



POL-0750



POL-0751



POL-0752



POL-1240



POL-1241



POL-0206



POL-0207



POL-1207

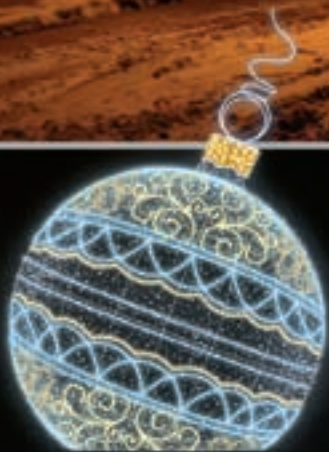

POL-2907



POL-1260



POL-0362



POL-0755



POL-1709



POL-0759



POL-0770



POL-0043B

DECORATIONS - COLLECTIONS
 DEKORACJE - KOLEKCJE
 COLLECTION 29

The collections presented below are sets of well-chosen universal, lamp post, street, and building decorations. These examples may be helpful to create own collections.

Prezentowane poniżej kolekcje to zestawy odpowiednio dobranych dekoracji uniwersalnych, latarniowych, ulicznych i elewacyjnych. Przykłady te mogą być pomocne w tworzeniu własnych kolekcji.



POL-2909

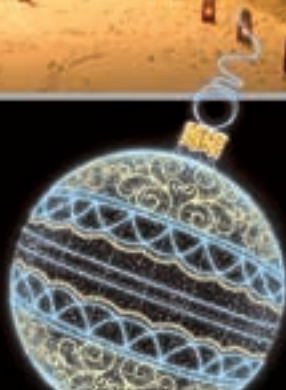

POL-2907



POL-0350



POL-0240



POL-0241



POL-0262M



POL-1270



POL-1255



POL-0760



POL-0920



POL-1937



POL-0967



POL-0366



POL-0820



POL-0816



POL-0822



POL-0728



POL-0725



POL-0767

DECORATIONS - COLLECTIONS
 DEKORACJE - KOLEKCJE
 COLLECTION 25

The collections presented below are sets of well-chosen universal, lamp post, street, and building decorations. These examples may be helpful to create own collections.

Prezentowane poniżej kolekcje to zestawy odpowiednio dobranych dekoracji uniwersalnych, latarniowych, ulicznych i elewacyjnych. Przykłady te mogą być pomocne w tworzeniu własnych kolekcji.



POL-1328



POL-0806



POL-0807



POL-0527



POL-0522



POL-0704



POL-0528



POL-1751



POL-1709M



POL-1711



POL-17038



POL-0631



POL-1990

DECORATIONS - COLLECTIONS
DEKORACJE - KOLEKCJE
COLLECTION 27

The collections presented below are sets of well-chosen universal, lamp post, street, and building decorations. These examples may be helpful to create own collections.

Prezentowane poniżej kolekcje to zestawy odpowiednio dobranych dekoracji uniwersalnych, latarniowych, ulicznych i elewacyjnych. Przykłady te mogą być pomocne w tworzeniu własnych kolekcji.



POL-1106



POL-1105



POL-1108



POL-1109



POL-0928M



POL-0980M/G



POL-0926M



POL-0927M



POL-0266



POL-0983M/G



POL-0981M/G



POL-0978M/G



POL-1920M



POL-1110



POL-0944



POL-1107



POL-1108



POL-1109



POL-0928M



POL-0267



POL-0268



POL-0975M/G

DECORATIONS - COLLECTIONS
 DEKORACJE - KOLEKCJE
 COLLECTION 17

The collections presented below are sets of well-chosen universal, lamp post, street, and building decorations. These examples may be helpful to create own collections.

Prezentowane poniżej kolekcje to zestawy odpowiednio dobranych dekoracji uniwersalnych, latarniowych, ulicznych i elewacyjnych. Przykłady te mogą być pomocne w tworzeniu własnych kolekcji.



POL-1300

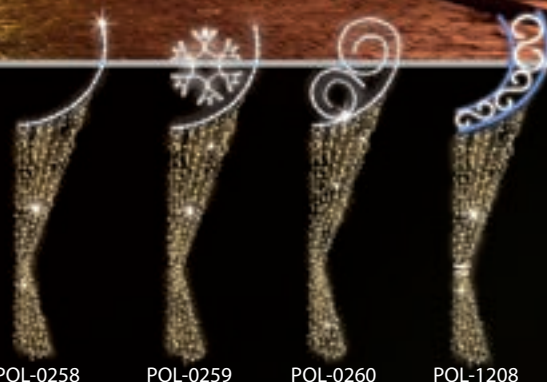

POL-0258 POL-0259 POL-0260 POL-1208



POL-1209 POL-1705 POL-1740M POL-1741 POL-1745 POL-1737 POL-0726



POL-1700

POL-1701

POL-1702



POL-1303



POL-0215



POL-0742



POL-1723



POL-1703



POL-1704



POL-1705



POL-1706



POL-1707



POL-1313

Wesołych Świąt



POL-0009M

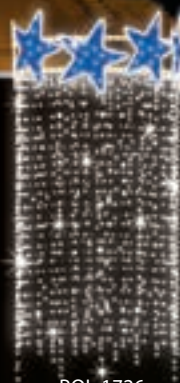

POL-1726



POL-1722



POL-0023M



POL-0220



POL-0220M



POL-0237



POL-0237M



POL-0222



POL-1218



POL-1206

POL-1309



POL-1229



POL-1722



POL-0026B



POL-0098B



POL-0092B-1



POL-1241



POL-0232M

DECORATIONS - COLLECTIONS
 DEKORACJE - KOLEKCJE
 COLLECTION 21

The collections presented below are sets of well-chosen universal, lamp post, street, and building decorations. These examples may be helpful to create own collections.

Prezentowane poniżej kolekcje to zestawy odpowiednio dobranych dekoracji uniwersalnych, latarniowych, ulicznych i elewacyjnych. Przykłady te mogą być pomocne w tworzeniu własnych kolekcji.



POL-1302



POL-0260



POL-1210



POL-0025



POL-0026



POL-0121



POL-1201



POL-0240



POL-0241



POL-0262M



POL-0260

POL-1208

POL-1209



POL-1351



POL-0701



POL-0703



POL-0706

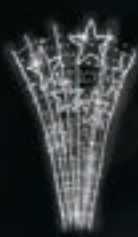

POL-0725



POL-0726



POL-0749

DECORATIONS - COLLECTIONS
 DEKORACJE - KOLEKCJE
 COLLECTION 23

The collections presented below are sets of well-chosen universal, lamp post, street, and building decorations. These examples may be helpful to create own collections.

Prezentowane poniżej kolekcje to zestawy odpowiednio dobranych dekoracji uniwersalnych, latarniowych, ulicznych i elewacyjnych. Przykłady te mogą być pomocne w tworzeniu własnych kolekcji.



POL-1307



POL-0244

POL-1200



POL-1751



POL-0749

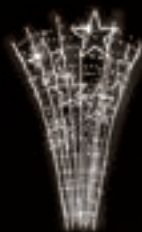

POL-0725



POL-0726



POL-0701



POL-0090



POL-1937



POL-1350



POL-0091



POL-0089



POL-0088



POL-0911



POL-0913

DECORATIONS - COLLECTIONS
 DEKORACJE - KOLEKCJE
 COLLECTION 03

The collections presented below are sets of well-chosen universal, lamp post, street, and building decorations. These examples may be helpful to create own collections.

Prezentowane poniżej kolekcje to zestawy odpowiednio dobranych dekoracji uniwersalnych, latarniowych, ulicznych i elewacyjnych. Przykłady te mogą być pomocne w tworzeniu własnych kolekcji.



POL-0350



POL-0240

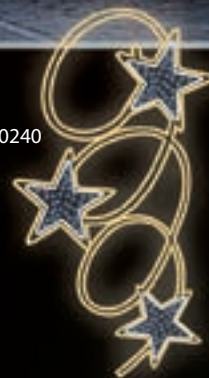

POL-0255



POL-0251



POL-0722



POL-0020



POL-0021



POL-0223



POL-0311



POL-0002



POL-0125



POL-0220



POL-0186



POL-0106



POL-0107



POL-0221

DECORATIONS - COLLECTIONS
 DEKORACJE - KOLEKCJE
 COLLECTION 09

The collections presented below are sets of well-chosen universal, lamp post, street, and building decorations. These examples may be helpful to create own collections.

Prezentowane poniżej kolekcje to zestawy odpowiednio dobranych dekoracji uniwersalnych, latarniowych, ulicznych i elewacyjnych. Przykłady te mogą być pomocne w tworzeniu własnych kolekcji.



POL-0360



POL-0009M



POL-0248

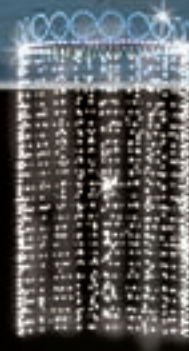

POL-0705



POL-0215



POL-0193

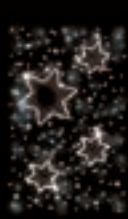

POL-0232



POL-0727



POL-0220



POL-0221



POL-0218



POL-0217



POL-0704



POL-0237



POL-0256



POL-0399



POL-0220



POL-0221



POL-0218



POL-0202



POL-0234



POL-0236



POL-0203



POL-0204

DECORATIONS - COLLECTIONS
 DEKORACJE - KOLEKCJE
 COLLECTION 11

The collections presented below are sets of well-chosen universal, lamp post, street, and building decorations. These examples may be helpful to create own collections.

Prezentowane poniżej kolekcje to zestawy odpowiednio dobranych dekoracji uniwersalnych, latarniowych, ulicznych i elewacyjnych. Przykłady te mogą być pomocne w tworzeniu własnych kolekcji.



POL-0340

POL-0107M



POL-0167M



POL-0183



POL-0220



POL-0221



POL-0234



POL-0256



POL-0233



POL-0202



POL-0203



POL-0183



POL-0342



POL-0151



POL-0149



POL-0236



POL-0256



POL-0233



POL-0202



POL-0204

DECORATIONS - COLLECTIONS
 DEKORACJE - KOLEKCJE
 COLLECTION 13

The collections presented below are sets of well-chosen universal, lamp post, street, and building decorations. These examples may be helpful to create own collections.

Prezentowane poniżej kolekcje to zestawy odpowiednio dobranych dekoracji uniwersalnych, latarniowych, ulicznych i elewacyjnych. Przykłady te mogą być pomocne w tworzeniu własnych kolekcji.



POL-0393

POL-0025



POL-0211



POL-0253



POL-0010



POL-0024



POL-0026



POL-0205



POL-0251



POL-0703



POL-0713



POL-0252

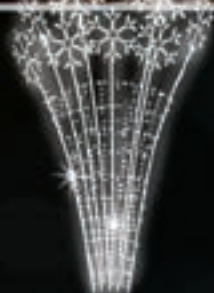

POL-0725



POL-0023



POL-0397

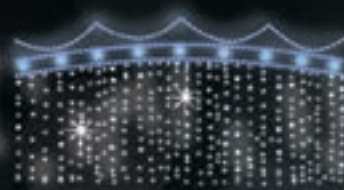

POL-0717



POL-0707



POL-0232



POL-0525



POL-0009



POL-0027



POL-0014

DECORATIONS - COLLECTIONS
 DEKORACJE - KOLEKCJE
 COLLECTION 15

The collections presented below are sets of well-chosen universal, lamp post, street, and building decorations. These examples may be helpful to create own collections.

Prezentowane poniżej kolekcje to zestawy odpowiednio dobranych dekoracji uniwersalnych, latarniowych, ulicznych i elewacyjnych. Przykłady te mogą być pomocne w tworzeniu własnych kolekcji.



POL-0354M



POL-0265M



POL-0002M

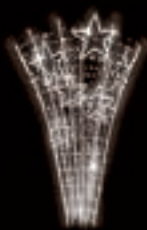

POL-0724



POL-0240



POL-0263M



POL-0262M



POL-0002M



POL-0330M



POL-0220



POL-0232



POL-0232M



POL-0030

CHRISTMAS ILLUMINATIONS

OŚWIETLENIE ŚWIĄTECZNE

We have several hundred products in our offer of Christmas illuminations. Every product is based on LED technology.

LEDs are a source of visible light, which use infra red waves. It has a lot of advantages such as small size, long life, reliability and energy saving.

Our offer is divided into 4 groups. Brown series: only for indoor use. LEDs are damage resistant. Suitable for Christmas trees, homes, flats, offices and other indoor decorations. Silver series: Suitable for indoor and outdoor decorations. LEDs are moisture resistant. Plug can be used in earthed sockets. Gold series: Suitable for outdoor use. Cable is isolated with rubber (unlike other series which are isolated with PVC). It has hermetic connections and special system that prevents cable from breaking. Green series: It has the same specification as gold and silver series, but it operates on 24V. This voltage prevents from electric shock and any other damages to people.

W grupie oświetlenia świątecznego produkowanego przez POLAMP znajduje się kilkaset produktów. Wszystkie wykorzystują diody LED.

Diody LED to źródła światła widzialnego wykorzystujące niewidzialne fale podczerwieni. Mają wiele zalet, wśród nich małe rozmiary, tysiące godzin żywotności świetlnej, niezawodność, czy energooszczędność wydają się najważniejsze.

Ofertę podzieliliśmy na 4 grupy produktów. Seria brązowa do użytku tylko we wnętrzach. Dioda LED zabezpieczona jest przed uszkodzeniami mechanicznymi. Przeznaczona jest do pomieszczeń, domowych choinek i innych bardziej indywidualnych dekoracji w mieszkaniach, czy biurach. Seria srebrna do dekorowania pomieszczeń, jak i obszarów poza budynkiem. Dioda LED zabezpieczona przed wilgocią. Wtyczka przystosowana do gniazdka z uziemieniem. Seria złota przeznaczona na zewnątrz. Przewód ochrania osłonka gumowa, a nie PVC jak w pozostałych liniach wyrobów. Poza inteligentnym (hermetycznym) połączeniem kabli, jak w przypadku serii brązowej i srebrnej, posiada system zabezpieczający przed zerwaniem okablowania, np. z powodu rozrastania się drzewa. Seria zielona to grupa produktów o specyfikacji technicznej, kolorystyce i wymiarach, jak w linii złotej i srebrnej. Wyróżnia je działanie na obniżone napięcie 24V. Jest to wartość, która nie powoduje żadnego uszczerbku na zdrowiu człowieka.



Our LED Christmas illuminations are produced in different colours. There are several colours available in our offer. For a special order, we can offer other colour. Standard colours in our offer are white, multicolour and RGB dependently to a certain product. The main purpose of Christmas illuminations is decorating our personal space at night. LEDs can help you save energy during couple of hours every day or night.

In our stock we have LED Christmas lights, small and standard LED curtains, rope lights. Some of the special decorations are plywood light decorations such as Christmas tree, stars and crib. Apart from that, we have meteors, projectors, accessories, etc.

We work hard before each season to expand our offer. If you visit one of our wholesalers or our online shop, you will have wide range of decorations with different size, shape and technical specification.

Oświetlenie świąteczne LED produkujemy w dowolnych kolorach, w ofercie katalogowej jest ich kilkanaście. Na indywidualne zamówienie jesteśmy w stanie zaproponować inną barwę. Obowiązkowa w ofercie jest biel, multikolor i RGB, w zależności od wybranego produktu. Zadanie iluminacji świątecznych to przede wszystkim zdobienie przestrzeni po zmroku. Zastosowanie diod LED pozwala oszczędzać energię podczas tych paru, czy kilkunastu godzin codziennego świecenia.

W asortymencie posiadamy lampki choinkowe LED, kurtynki i kurtyny LED, czy węże świetlne. Wyjątkową grupą są ozdoby ze sklejki rozświetlane od wewnątrz, jak szopka, choinka i gwiazdy. Oprócz nich również meteorki, projektory, akcesoria itp.

Przed każdym kolejnym sezonem pracujemy nad rozszerzeniem oferty o nowe propozycje. Odwiedzając nasze hurtownie lub sklep internetowy, masz ogromny wybór ozdób o rozmaitych kształtach i innych parametrach technicznych.



LED string lights
Lampki LED



24V LED string lights
Lampki LED 24V



SOLAR LED string lights
Lampki LED Solar



CRACKER LED string
Lampki LED Gęste



BALL LED lights
Lampki LED Kulki



BIG balls LED lights
Lampki LED Bomby



Ornament led string lights
Lampki LED Ornamenty



Candle led string lights
Lampki LED Świeczki



Tears styled LED lights
Lampki LED Łezki



Snowflake LED lights
Snieżynka LED



Wooden LED decorations
Drewniane ozdoby LED



Cotton and rattan LED lights
Lampki kulki baweł. i ratanowe



Icicle LED curtains
Kurtynki LED



LONG icicle LED curtains
Kurtynki długie LED



Icicle star LED curtains
Kurtynki gwiazdki LED



LED curtains
Kurtyny LED



LED nets
Siatki LED



WATERFALL curtains
Kurtyny Waterfall



LED rope lights
Węże LED



BULB rope lights
Węże żarówkowe



NEON LED rope lights
Węże LED NEON



NEON LED rope lights 12V
Węże LED NEON 12V



LED meteors
Meteorki LED



LED stalactites
Stalaktyty LED

WE OFFER 4 PRODUCT LINES OF CHRISTMAS ILLUMINATION OFERUJEMY CZTERY LINIE OŚWIETLENIA ŚWIĄTECZNEGO



gold series / seria złota

- perfect for outdoor use
- 3mm thick rubber cable which is perfect in difficult weather conditions
- special system that prevents cable from breaking while the tree is growing
- 8mm LED CUP which are damage and splash proof (rubber shrink tie)
- super connect technology
- round EU plug which is also a power supply
- FLASH LED option
- IP65/IP67

DECORATIVE use:

- streets, poles, buildings
- trees, shrubs, christmas trees
- balconies, ells, terraces
- yearlong decorations

• polecana szczególnie w dekoracjach zewnętrznych

- gumowy gruby przewód 3 mm zapewniający bezpieczeństwo w trudnych warunkach atmosferycznych
- system zabezpieczający przed zerwaniem kabla w miarę przyrostu drzewa
- dioda LED w obudowie 8mm zabezpieczona przed wilgocią i uszkodzeniami mechanicznymi (gumowa koszulka)
- system super-połączenie
- nie wymaga użycia zasilacza
- wtyczka duża (okrągła)
- opcja diod FLASH
- IP65/IP67

Zastosowanie w dekoracji:

- ulic, słupów, budynków
- choinek, drzew, krzewów
- domowych balkonów, elewacji, tarasów
- całorocznych dekoracji



silver series / seria srebrna

- for both indoor and outdoor use
- 2mm PVC cable which is slightly thinner than rubber cable, but still waterproof
- 5mm LEDs which are damage and splash proof (rubber shrink tie)
- super connect technology
- round EU plug which is also a power supply
- 8 function controlling mode option
- FLASH LED option
- IP44

DECORATIVE use:

- streets, poles, buildings
- trees, shrubs, christmas trees
- indoor christmas trees, garlands
- balconies, ells, terraces
- shop windows
- yearlong decorations

• możliwość stosowania w dekoracjach zewnętrznych i wew.

- przewód PVC 2 mm stosunkowo cieńszy od przewodu gumowego, choć nadal daje gwar. wodoodporności
- średnia dioda LED 5mm zabezpieczona przed wilgocią i uszkodzeniami mechanicznymi (gumowa koszulka)
- system super-połączenie
- nie wymaga użycia zasilacza
- wtyczka duża (okrągła)
- opcja 8 funkcyjnego sterownika
- opcja diod FLASH
- IP44

Zastosowanie w dekoracji:

- ulic, słupów, budynków
- choinek, drzew, krzewów
- domowych choinek, girland
- domowych balkonów, elewacji, tarasów
- dekoracji witryn sklepowych
- całorocznych dekoracji

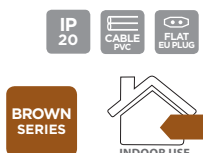

brown series / seria brązowa

- only for indoor use
- 2mm PVC cable which is slightly thinner than rubber cable
- 3 and 5 mm LEDs which are damage proof
- flat EU plug which is also a power supply
- 8 function controlling mode option
- FLASH LED option
- IP20

DECORATIVE use:

- indoor christmas trees and garlands
- balconies, ells and terraces
- shop windows
- yearlong decorations

• stosowanie tylko w dekoracjach wewnętrznych

- przewód PVC 2 mm stosunkowo cieńszy od przewodu gumowego
- średnia dioda LED (3 mm i 5 mm) zabezpieczona przed uszkodzeniami mechanicznymi
- wtyczka mała (płaska)
- nie wymaga użycia zasilacza
- opcja 8 funkcyjnego sterownika
- opcja diod FLASH
- IP20

Zastosowanie w dekoracji:

- domowych choinek, girland
- domowych balkonów, elewacji, tarasów
- dekoracji witryn sklepowych
- całorocznych dekoracji



green series / seria zielona

- for both indoor and outdoor use
- PVC/rubber cable
- 5mm/8mm (cup) LEDs which are damage and splash proof (rubber shrink tie)
- super connect technology
- 24V power supply required
- 8 function controlling mode option
- FLASH LED option
- IP65/IP67/IP44

DECORATIVE use:

- streets, poles, buildings
- trees, shrubs, christmas trees
- indoor christmas trees, garlands
- balconies, ells, terraces
- shop windows
- yearlong decorations

• możliwość stosowania w dekoracjach zewnętrznych i wew.

- przewód PVC/rubber
- dioda LED 5mm/8mm (obudowa) zabezpieczona przed uszkodzeniami mechanicznymi i wilgocią (gumowa koszulka)
- system super-połączenie
- wymaga użycia zasilacza 24V
- opcja 8 funkcyjnego sterownika
- opcja diod FLASH
- IP65/IP67/IP44

Zastosowanie w dekoracji:

- ulic, słupów, budynków
- choinek, drzew, krzewów
- domowych choinek, girland
- domowych balkonów, elewacji, tarasów
- dekoracji witryn sklepowych
- całorocznych dekoracji

LED CHRISTMAS ILLUMINATIONS ARE AVAILABLE IN THE FOLLOWING COLOURS
 OŚWIETLENIE ŚWIĄTECZNE LED JEST DOSTĘPNE W NASTĘPUJĄCYCH KOLORACH



cw cold white biały zimny **nw** neutral white biały neutralny **ww** warm white biały ciepły **clw** classic white biały klasyczny **y** yellow żółty **o** orange pomarańczowy **p** pink różowy **pu** purple fioletowy **r** red czerwony **blu** blue niebieski **sblu** water blue niebieski morski **g** green zielony **m** multicolor multikolor **rgb** RGB

PRODUCT NAMES INDEX / OBJAŚNIENIE NAZW PRODUKTÓW

- **POL** - POLAMP
 - **LIL, LSL, LCL**, etc. - product
 - **P** - professional series
 - **IN** - indoor use
 - **F** - FLASH effect
 - **c** - control unit
 - **10M** - product length without power supply cable
 - **2.5x3.0** - dimension
 - **CW** - cold white, **WW** - warm white, **CLW** - classic white, **Y** - yellow, **O** - orange, **P** - pink, **PU** - purple, **R** - red, **BLU** - blue, **SBLU** - water blue, **G** - green, **M** - multicolour, **RGB** - RGB
 - second: **W** after dash - white cable, **B** - black, **G** - green, etc.
- **POL** - POLAMP
 - **LIL, LSL, LCL** itp. - oznacza produkt,
 - **P** - przed oznaczeniem produktu oznacza serię profesjonalną,
 - **IN** - po oznaczeniu produktu oznacza stosowanie do wewnątrz
 - **F** - efekt flash,
 - **c** - programator,
 - **10M** - długość źródła bez kabla zasilającego,
 - **2,5x3,0** - wymiar,
 - pierwszy po myślniku skrót: **CW** - biały zimny, **WW** - biały ciepły, **CLW** - biały klasyczny, **Y** - żółty, **O** - pomarańcz, **P** - różowy, **PU** - fioletowy, **R** - czerwony, **BLU** - niebieski, **SBLU** - niebieski morski, **G** - zielony, **M** - multikolor, **RGB** - dioda wielokolorowa RGB,
 - kolejne po myślniku: **W** - przewód biały, **B** - czarny, **G** - zielony, itp.

EXAMPLES / PRZYKŁADY

NAME NOMENCLATURE
 OZNACZENIE PRODUKTU W NAZWIE



POL-LSLIN6M-G-G
 indoor use green (G) LED string lights (LSL), 6 meter green cable (G)
 lampki LED (LSL) do wewnątrz (IN), długość przewodu 6m (6M), kolor
 lampek zielony (G), przewód zielony (G)

POL-LSL6M-G

LSL - silver series lights / lampki seria srebrna
LSLIN - brown series lights / lampki seria brązowa
PLSL - gold series lights / lampki seria złota



POL-PLSLF10M-BLU-BLU
 outdoor use professional (P) flash effect blue LED string lights
 (BLU), 10 meter blue cable (BLU).
 profesjonalne (P) lampki LED (PLSL) na zewnątrz z efektem flash (f) długość
 przewodu 10 m (10M), kolor lampek niebieski (BLU), przewód niebieski (BLU)

LIL - silver series icicle curtains
 kurtynki seria srebrna
PLIL - gold series icicle curtains
 kurtynki seria złota



POL-PLSLbrm10M-RGB-G
 outdoor use professional (P) RGB LED string lights, balls with
 remote control (rm) and 10m green (G) cable.
 profesjonalne (P) lampki LED (PLSL) na zewnątrz, kulki (b) z pilotem (rc),
 długość przewodu 10 m (10M), kolor lampek RGB (RGB), przewód zielony (G)

LCL - silver series curtains / kurtyny seria srebrna
PLCL - gold series curtains / kurtyny seria złota



POL-OLSLsn10M-CW-G
 indoor use ornament (OLSL) cold white LED string lights (CW),
 snowflakes on a 10 meter green cable (G)
 lampki ornamenty LED (OLSL) do wewnątrz, kształt ornamentu - śnieżynki
 (sn), długość przewodu 10 m (10M), kolor lampek biały zimny (CW), przewód
 zielony (G)

LCLwf - waterfall effect curtains
 kurtyny z efektem wodospadu

LNL - LED net / siatka

MET - meteors / meteorki

LSTL - stalactites / stalaktyty

LRL - LED rope light / wąż LED
RRL - bulb rope light / wąż żarówkowy
LNF - NEON rope light / wąż NEON



POL-PLLILF5M-WW-W
 outdoor use professional (P) flash (f) effect warm white LED
 (WW) curtains on a 5 meter white (W) cable
 profesjonalne (P), długie (L) kurtynki LED (LIL) na zewnątrz z efektem flash
 (f) na przewodzie o długości 5 m (5M), kolor lampek biały (WW), przewód
 biały (W)



POL-LCL5X0,5-CW-T
 outdoor use cold white (CW) LED curtains (LCL) on transparent
 (T) cable with 5x0.5m dimensions
 kurtyny LED (LCL) na zewnątrz o wymiarach 5x0,5m (5X0,5), kolor lampek
 biały zimny (CW), przewód transparentny (T)

CHRISTMAS ILLUMINATIONS

LED STRING LIGHTS

OŚWIETLENIE ŚWIĄTECZNE **LAMPKI LED**

The base of our Christmas offer are LED lights. It is the most common decoration at home and in the office. Christmas trees are also often decorated with lights.

We sell lights in more than 100 variants. All of them are catalogued into our 4 product lines appropriate to its intended use, indoor - brown (230V) and green (24V) outdoor/indoor - silver, outdoor only - gold

We provided plenty of colour combinations of both light sources and cables. Light angle of all the lights is 360 degrees. The longest cable is 10 meters and is available in all the product lines. In most cases, there is a possibility of connecting together up to 10 cables to one power supply. Quick and easy connection is provided by a special plug. LEDs are placed each 10 centimeters, and have a lifespan of 100000 hours.

Standard LED lights are cables of 6 to 10 meters in length in brown collection. They have from 60 to 1000 LEDs in different colours. There is a choice between one and multicolour. Our LEDs work with no problem in sets up to 10 connected to one power supply. In the silver series we highly recommend 6 meter cable suitable for outdoor use. You can choose a colour from a wide range in our catalogue, or propose your own. We also have RGB lights. In the gold series we offer professional LED lights suitable for outdoor use, in different both cable and LED colours. In the middle there is a special socket that allows you to connect additional 5 meters of cable.

We have a wide variety of products in the LED flash section. In the silver series you can choose 100 LEDs on a 10 meter cable. LEDs flash automatically, you can connect together up to 10 sets of lights. The same specifications you can find in gold series which is typical for outdoor use. The only difference is a special socket that allows you to connect additional 5 meters of cable.

Podstawą oferty świątecznej POLAMP są lampki LED, spotykamy je w większości domów i w prawie każdym biurze, bardzo często wiszą na choinkach przed budynkami.

Sprzedajemy ponad 100 wariantów lampek. Wszystkie uporządkowaliśmy w 4 liniach, zgodnie z przeznaczeniem, do wnętrz - brązowa (230V) i zielona (24V), do pomieszczeń i na zewnątrz - srebrna, tylko do użytku zewnętrzne-go, odporna na zmienne warunki atmosferyczne - złota.

Przygotowaliśmy najróżniejsze rozwiązania kolorystyczne, zarówno źródeł światła, jak i okablowania. Kąt świecenia wszystkich lampek to 360°. Najdłuższy sznur mierzy 10 metrów i jest dostępny w każdej z linii produktów. W wielu przypadkach istnieje możliwość połączenia ze sobą maksymalnie 10 sznurów na jednym kablu zasilającym. Szybkie i łatwe łączenie zapewnia opatentowana złączka. Diody LED rozmieszczone są co 10 centymetrów. Mają żywotność 100000 godzin świecenia.

Standardowe lampki LED to sznury o długości 6 lub 10 metrów w kolekcji brązowej. Mające odpowiednio 60 i 100 diod zróżnicowanych kolorystycznie. Do wyboru są lampki jednobarwne, jak i biały oraz multikolor. Działają bez zarzutu w zestawie do 10 kompletów na 1 kablu zasilającym. W serii srebrnej proponujemy sznur 6-metrowy na zewnątrz. Kolor do wyboru z katalogu lub tworzony na życzenie Klienta, mamy też lampki RGB. W ramach linii złotej oferujemy profesjonalne lampki LED do użytku zewnętrznego o różnych kolorach zarówno kabla, jak i diod. Po środku mają opatentowaną złączkę, pozwalającą łączyć sznur 5 + 5 m.

Niezwykle rozbudowaną ofertę mamy w grupie lampek LED FLASH. W ramach kolekcji srebrnej zewnętrzne lampki 100 diod na 10-metrowym sznurze. Błysk działa automatycznie. Granica kompatybilności to 10 kompletów. Tą samą kolorystykę i ilości diod przygotowaliśmy dla serii złotej typowo zewnętrznej. Wyróżniają się złączką umożliwiającą spięcie kabla na kombinacje 5 + 5 m.



Next to the standard frame, the lamps can be in the form balls with a diameter of 1.5 to 2.2 cm, in a width system, snowflakes, flowers. The lamps in the form also look original rattan or cotton balls, classic candles or large glass balls with a diameter of 10 cm.

Obok standardowych opravek lampki mogą być w formie kulek o średnicy od 1,5 do 2,2 cm, w kształcie gwiazdek, śnieżynek, kwiatków. Oryginalnie wyglądają też lampki w formie ratanowych lub bawełnianych kulek, klasycznych świeczek czy dużych bombek o średnicy 10 cm.



Some of our lights are battery powered, which we add in the set together with container.

Niektóre nasze lampki zasilane są bateriami, które dodajemy w zestawie razem z pojemnikiem.



We also offer solar lamps equipped in the solar panel.

W ofercie posiadamy też lampki solarne wyposażone w panel słoneczny.



Ornaments constitute a separate group of decorations wooden LED illuminated.

Osobną grupę dekoracji stanowią ozdoby drewniane podświetlane diodami led.



The SUPERCONNECT connector is weather resistant and easy to use. It is found in products from the gold, silver and green series.

Złączka SUPERCONNECT jest odporna na warunki atmosferyczne i łatwa w użyciu. Występuje w produktach z serii złotej, srebrnej i zielonej.

Diagram of lights. Description of elements and dimensions.
Schemat lampek. Opisy elementów i wymiarowań.

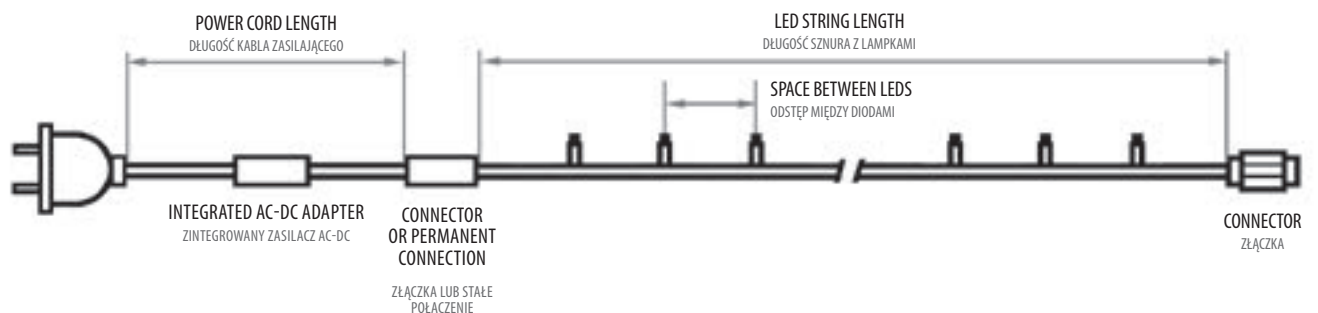

LED STRING LIGHTS 6 m LAMPKI LED 6 m



Power / Moc	3,5 W
Voltage / Zasilanie	230 V
Quantity of LEDs / Ilość diod w komplecie	60
Cable length / Długość sznura	6 m
Beam angle / Kąt świecenia	360°
Max connecting / Kompatybilność	up to 10 sets
Waterproof / Bryzgoszczelne	no (IP20)
Type of cable / Rodzaj kabla	PVC 2mm
Type of plug / Rodzaj wtyczki	flat EU
Index:	POL-LSLIN6M-CW-G POL-LSLIN6M-Y-G POL-LSLIN6M-BLU-G POL-LSLIN6M-WW-G POL-LSLIN6M-P-G POL-LSLIN6M-G-G POL-LSLIN6M-CLW-G POL-LSLIN6M-R-G POL-LSLIN6M-M-G



BROWN SERIES

available LED colours
dostępne kolory LED



available cable colours
dostępne kolory przewodu

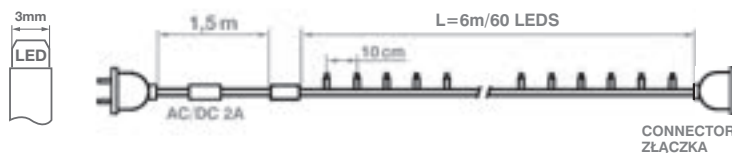

LED STRING LIGHTS 10 m LAMPKI LED 10 m



Power / Moc	6,9 W
Voltage / Zasilanie	230 V
Quantity of LEDs / Ilość diod w komplecie	100
Cable length / Długość sznura	10 m
Beam angle / Kąt świecenia	360°
Max connecting / Kompatybilność	up to 10 sets
Waterproof / Bryzgoszczelne	no (IP20)
Type of cable / Rodzaj kabla	PVC 2mm
Type of plug / Rodzaj wtyczki	flat EU
Index:	POL-LSLIN10M-CW-G POL-LSLIN10M-Y-G POL-LSLIN10M-BLU-G POL-LSLIN10M-WW-G POL-LSLIN10M-P-G POL-LSLIN10M-G-G POL-LSLIN10M-CLW-G POL-LSLIN10M-R-G POL-LSLIN10M-M-G



BROWN SERIES

available LED colours
dostępne kolory LED



available cable colours
dostępne kolory przewodu

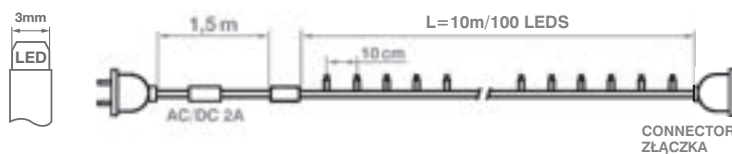

LED STRING LIGHTS 10 m LAMPKI LED 10 m



Power / Moc	6,9 W
Voltage / Zasilanie	230 V
Quantity of LEDs / Ilość diod w komplecie	100
Cable length / Długość sznura	10 m
Beam angle / Kąt świecenia	360°
Max connecting / Kompatybilność	up to 10 sets
Waterproof / Bryzgoszczelne	yes (IP44)
Type of cable / Rodzaj kabla	PVC 2mm
Type of plug / Rodzaj wtyczki	round EU
Index:	POL-LSL10M-CW-W POL-LSL10M-Y-G POL-LSL10M-G-G POL-LSL10M-CW-G POL-LSL10M-P-G POL-LSL10M-M-G POL-LSL10M-WW-W POL-LSL10M-R-G POL-LSL10M-RGB-G POL-LSL10M-WW-G POL-LSL10M-PU-G POL-LSL10M-CLW-G POL-LSL10M-BLU-G



SILVER SERIES

available LED colours
dostępne kolory LED



available cable colours
dostępne kolory przewodu

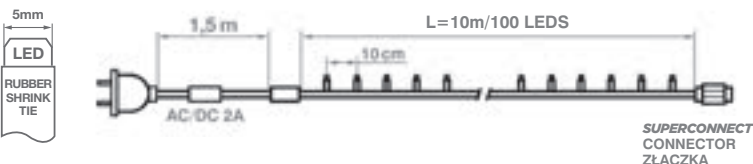

The diodes in the strings (silver and gold series) have a rubber shirt and 8mm cup in gold series.

Diody w lampkach z serii srebrnej i złotej posiadają gumową koszulkę, a w serii złotej dodatkowo obudowę 8 mm.

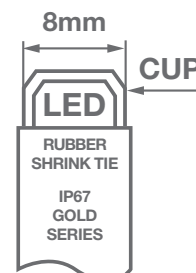

LED STRING LIGHTS PRO 10 m (5+5)
LAMPKI LED PRO 10 m (5+5)



Power / Moc	9,2 W
Voltage / Zasilanie	230 V
Quantity of LEDs / Ilość diod w komplecie	100
Cable length / Długość sznura	10 m (5+5)
Beam angle / Kąt świecenia	360°
Max connecting / Kompatybilność	up to 10 sets
Waterproof / Bryzgoszczelne	yes (IP65)
Type of cable / Rodzaj kabla	rubber 3,2mm
Type of plug / Rodzaj wtyczki	round EU

Index:	POL-PLSL10M-CW-W POL-PLSL10M-CW-G POL-PLSL10M-CW-BL POL-PLSL10M-NW-W POL-PLSL10M-NW-G POL-PLSL10M-WW-W POL-PLSL10M-WW-G POL-PLSL10M-WW-BL POL-PLSL10M-CLW-W POL-PLSL10M-CLW-G POL-PLSL10M-Y-Y	POL-PLSL10M-Y-BL POL-PLSL10M-R-R POL-PLSL10M-R-G POL-PLSL10M-R-BL POL-PLSL10M-PU-PU POL-PLSL10M-SBLU-W POL-PLSL10M-SBLU-BL POL-PLSL10M-SBLU-G POL-PLSL10M-SBLU-BL POL-PLSL10M-BLU-W	POL-PLSL10M-BLU-BL POL-PLSL10M-BLU-G POL-PLSL10M-BLU-BL POL-PLSL10M-G-G POL-PLSL10M-G-BL POL-PLSL10M-M-W POL-PLSL10M-M-G POL-PLSL10M-M-BL POL-PLSL10M-RGB-G POL-PLSL10M-RGB-BL
--------	---	--	---



available LED colours
dostępne kolory LED

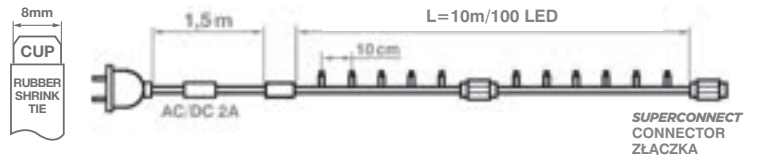

LED STRING LIGHTS FLASH 10 m
LAMPKI LED FLASH 10 m



Power / Moc	6,9 W
Voltage / Zasilanie	230 V
Quantity of LEDs / Ilość diod w komplecie	100
Cable length / Długość sznura	10 m
Beam angle / Kąt świecenia	360°
Max connecting / Kompatybilność	up to 10 sets
Waterproof / Bryzgoszczelne	yes (IP44)
Type of cable / Rodzaj kabla	PVC 2mm
Type of plug / Rodzaj wtyczki	round EU

Index:	POL-LSL10M-CW-W POL-LSL10M-CW-G	POL-LSL10M-WW-W POL-LSL10M-WW-G	POL-LSL10M-BLU-W POL-LSL10M-BLU-G
--------	------------------------------------	------------------------------------	--------------------------------------



80 LEDs + 20 LEDs FLASH cold white
80 LED + 20 LED FLASH białych zimnych

LED STRING LIGHTS PRO 10 m FLASH
LAMPKI LED PRO 10 m FLASH



Power / Moc	9,2 W
Voltage / Zasilanie	230 V
Quantity of LEDs / Ilość diod w komplecie	100
Cable length / Długość sznura	10 m (5+5)
Beam angle / Kąt świecenia	360°
Max connecting / Kompatybilność	up to 10 sets
Waterproof / Bryzgoszczelne	yes (IP65)
Type of cable / Rodzaj kabla	rubber 3,2mm
Type of plug / Rodzaj wtyczki	round EU

Index:	POL-PLSL10M-CW-W POL-PLSL10M-CW-G POL-PLSL10M-CW-BL POL-PLSL10M-WW-W POL-PLSL10M-WW-G POL-PLSL10M-WW-BL	POL-PLSL10M-Y-Y POL-PLSL10M-Y-BL POL-PLSL10M-R-R POL-PLSL10M-R-G POL-PLSL10M-R-BL POL-PLSL10M-PU-PU	POL-PLSL10M-PU-BL POL-PLSL10M-BLU-W POL-PLSL10M-BLU-BL POL-PLSL10M-BLU-G POL-PLSL10M-BLU-BL POL-PLSL10M-G-BL
--------	--	--	---



available LED colours
dostępne kolory LED



available cable colours
dostępne kolory przewodu

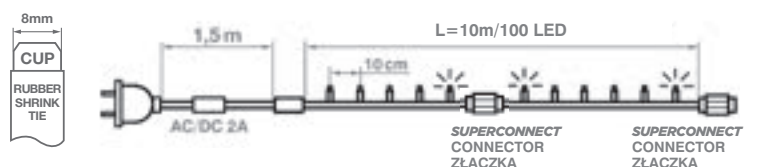

80 LEDs + 20 LEDs FLASH cold white
80 LED + 20 LED FLASH białych zimnych

LED STRING LIGHTS PRO ALL FLASH LAMPKI LED PRO 10 m wszystkie FLASH



Power / Moc	9,2 W
Voltage / Zasilanie	230 V
Quantity of LEDs / Ilość diod w komplecie	100
Cable length / Długość sznura	10 m (5+5)
Beam angle / Kąt świecenia	360°
Max connecting / Kompatybilność	up to 10 sets
Waterproof / Bryzgoszczelne	yes (IP65)
Type of cable / Rodzaj kabla	rubber 3,2mm
Type of plug / Rodzaj wtyczki	round EU

Index: POL-PLSL100f10M-CW-W POL-PLSL100f10M-CW-BL

100 LEDs FLASH cold white
100 LED FLASH białych zimnych



GOLD SERIES

available LED colours
dostępne kolory LED



available cable colours
dostępne kolory przewodu

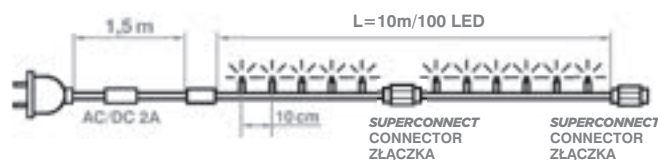

LED STRING LIGHTS 10 m LAMPKI LED 10 m



Power / Moc	6,9 W
Voltage / Zasilanie	230 V
Quantity of LEDs / Ilość diod w komplecie	100
Cable length / Długość sznura	10 m
Beam angle / Kąt świecenia	360°
Max connecting / Kompatybilność	up to 10 sets
Waterproof / Bryzgoszczelne	yes (IP44)
Type of cable / Rodzaj kabla	PVC 2mm
Type of plug / Rodzaj wtyczki	round EU

Index: POL-LSLc10M-CW-W POL-LSLc10M-Y-G POL-LSLc10M-G-G
POL-LSLc10M-CW-W POL-LSLc10M-R-G POL-LSLc10M-M-G
POL-LSLc10M-WW-W POL-LSLc10M-PU-G
POL-LSLc10M-WW-G POL-LSLc10M-BLU-G



SILVER SERIES

available LED colours
dostępne kolory LED



available cable colours
dostępne kolory przewodu

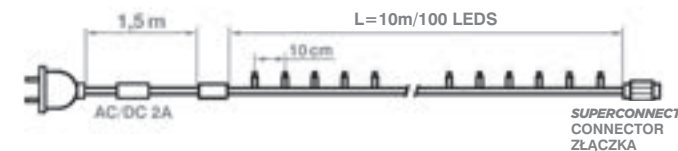

Lampki LED z programatorem to zewnętrzne lampki z opcjami animacji i w kolorach do wyboru lub na zamówienie oraz w multicolorze. Funkcje sterownika: stały, błyskający, przygasający, migający, pulsacyjny, sekwencyjny, płynący, kombinacja.

Lampki LED z programatorem to zewnętrzne lampki z opcjami animacji i w kolorach do wyboru lub na zamówienie oraz w multicolorze. Funkcje sterownika: stały, błyskający, przygasający, migający, pulsacyjny, sekwencyjny, płynący, kombinacja.

24V

GREEN SERIES

LED STRING LIGHTS 24V PRO LAMPKI LED 24V PRO 10 m (5+5)



Power / Moc	6,7 W
Voltage / Zasilanie	24 V
Quantity of LEDs / Ilość diod w komplecie	100
Cable length / Długość sznura	10 m (5+5)
Beam angle / Kąt świecenia	360°
Waterproof / Bryzgoszczelne	yes (IP65)
Type of cable / Rodzaj kabla	rubber 3,2mm

Index: POL-PLSL10M24V-CW-W POL-PLSL10M24V-WW-BL POL-PLSL10M24V-BLU-BL
 POL-PLSL10M24V-CW-BL POL-PLSL10M24V-Y-BL
 POL-PLSL10M24V-WW-W POL-PLSL10M24V-R-BL

Green series outdoor 24V LED lights also have 100 LEDs on a 10 meter cable. We offer one and multicolour combination. You can connect together up to 10 sets of lights to one power supply.

Lampki LED 24V zewnętrzne w ramach linii zielonej. Na 10 metrach sznura znajduje się 100 diod. Oferujemy kolory jednolite, jak i multikolor. Działają bez zarzutu w zestawie do 10 kompletów na jednym kablu zasilającym.



available LED colours
dostępne kolory LED

available cable colours
dostępne kolory przewodu



GREEN SERIES

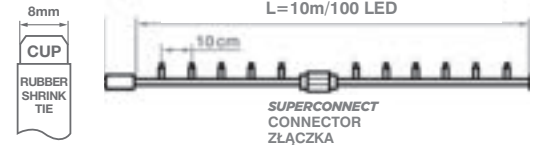

LED STRING LIGHTS 24V PRO FLASH LAMPKI LED 24V PRO 10 m (5+5) FLASH



Power / Moc	6,7 W
Voltage / Zasilanie	24 V
Quantity of LEDs / Ilość diod w komplecie	100
Cable length / Długość sznura	10 m (5+5)
Beam angle / Kąt świecenia	360°
Waterproof / Bryzgoszczelne	yes (IP65)
Type of cable / Rodzaj kabla	rubber 3,2mm

Index: POL-PLSLF10M24V-CW-W POL-PLSLF10M24V-WW-W POL-PLSLF10M24V-WW-BL
 POL-PLSLF10M24V-CW-BL POL-PLSLF10M24V-WW-G

80 LEDs + 20 LEDs FLASH cold white
 80 LED + 20 LED FLASH białych zimnych



available LED colours
dostępne kolory LED

available cable colours
dostępne kolory przewodu



GREEN SERIES

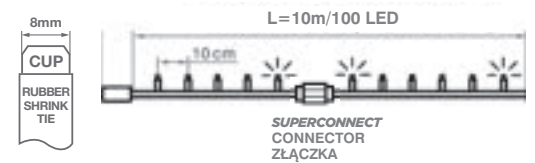

LED STRING LIGHTS 24V LAMPKI LED 24V



Power / Moc	6,7 W
Voltage / Zasilanie	24 V
Quantity of LEDs / Ilość diod w komplecie	100
Cable length / Długość sznura	10 m (5+5)
Beam angle / Kąt świecenia	360°
Waterproof / Bryzgoszczelne	yes (IP44)
Type of cable / Rodzaj kabla	PVC 2mm

Index: POL-LSL10M24V-CW-G POL-LSL10M24V-BLU-G
 POL-LSL10M24V-WW-G POL-LSL10M24V-M-G



available LED colours
dostępne kolory LED

available cable colours
dostępne kolory przewodu



GREEN SERIES

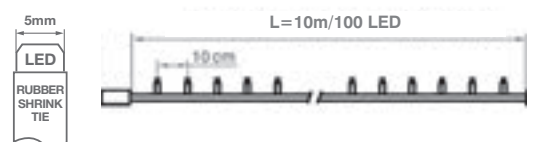



Super dense LED lights - as the name suggests, there are up to 300 white light sources on a 5 meter cable. You can connect up to 5 cables to one power supply.

Super Gęste Lampki LED wyróżnia ilość diod - aż 300 źródeł białego światła na 5-metrowym sznurze. Są kompatybilne w zestawie 5 sznurów na 1 kablu zasilającym.

LED STRING LIGHTS - SUPER DENSE LAMPKI LED SUPER GĘSTE PRO 5 m



Power / Moc	18 W
Voltage / Zasilanie	230 V
Quantity of LEDs / Ilość diod w komplecie	300
Cable length / Długość sznura	5 m (2,5+2,5)
Beam angle / Kąt świecenia	360°
Max connecting / Kompatybilność	up to 5 sets
Waterproof / Bryzgoszczelne	yes (IP65)
Type of cable / Rodzaj kabla	rubber 3,2mm
Type of plug / Rodzaj wtyczki	round EU

Index: POL-PCLSL5M-CW-W POL-PCLSL5M-WW-W
 POL-PCLSL5M-CW-BL POL-PCLSL5M-WW-BL



available LED colours
dostępne kolory LED



available cable colours
dostępne kolory przewodu

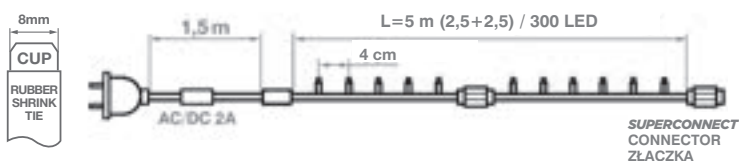

SOLAR LED STRING LIGHTS 10 m
LAMPKI Z PANELEM SŁONECZNYM LED 10 m



Power / Moc	5,5 W
Voltage / Zasilanie	SOLAR 3,6 V
Quantity of LEDs / Ilość diod w komplecie	100
Cable length / Długość sznura	10 m
Beam angle / Kąt świecenia	360°
Waterproof / Bryzgoszczelne	yes (IP44)
Type of cable / Rodzaj kabla	PVC 1,6mm

Index: POL-SLSL10M-CW-G POL-SLSL10M-WW-G POL-SLSL10M-M-G



available LED colours
dostępne kolory LED



available cable colours
dostępne kolory przewodu

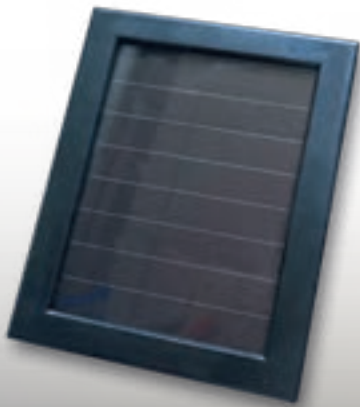
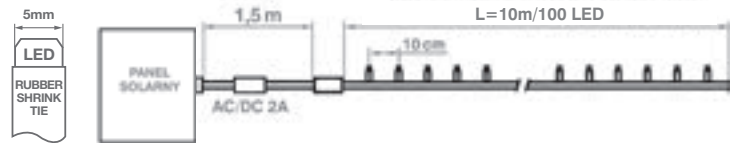

LED solar panel lights which can illuminate for 10 hours after dark. It charges during the day. There are standard catalogue colours, RGB and custom colours available.

Lampki LED z panelem słonecznym mogąym zasilać lampki przez 10 godz. po zmroku. Ładuje się podczas dnia. Dostępne są kolory katalogowe lub na zamówienie oraz wariant RGB.



LED BALL STRING LIGHTS LAMPKI LED KULKI



Power / Moc	6,9 W
Voltage / Zasilanie	230 V
Quantity of LEDs / Ilość diod w komplecie	100
Cable length / Długość sznura	10 m
Beam angle / Kąt świecenia	360°
Max connecting / Kompatybilność	up to 10 sets
Waterproof / Bryzgoszczelne	yes (IP44)
Type of cable / Rodzaj kabla	PVC 2mm
Type of plug / Rodzaj wtyczki	round EU

Index:	POL-LSLB10M-CW-G	POL-LSLB10M-R-G	POL-LSLB10M-BLU-G
	POL-LSLB10M-WW-G	POL-LSLB10M-PU-G	POL-LSLB10M-G-G
	POL-LSLB10M-Y-G	POL-LSLB10M-M-G	
	POL-LSLB10M-P-G	POL-LSLB10M-RGB-G	



SILVER SERIES

available LED colours
dostępne kolory LED



available cable colours
dostępne kolory przewodu

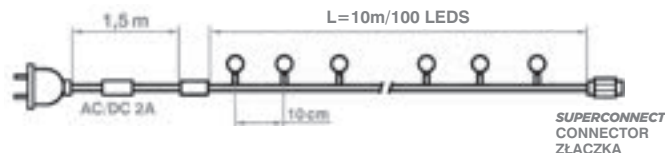

LED BALL STRING LIGHTS RC LAMPKI LED KULKI Z PILOTEM



Power / Moc	6,9 W
Voltage / Zasilanie	230 V
Quantity of LEDs / Ilość diod w komplecie	60
Cable length / Długość sznura	10 m
Beam angle / Kąt świecenia	360°
Max connecting / Kompatybilność	up to 10 sets
Remote controller / Pilot	yes
Waterproof / Bryzgoszczelne	yes (IP44)
Type of cable / Rodzaj kabla	PVC 2mm
Type of plug / Rodzaj wtyczki	round EU

* Długość sznura może nieznacznie odbiegać od podanej w tabeli i na rysunku. Średnica kulek w nowszej wersji oświetlenia wynosi 3 cm.

Index: POL-LSLbrm10M-RGB-G



SILVER SERIES

available LED colours
dostępne kolory LED



available cable colours
dostępne kolory przewodu

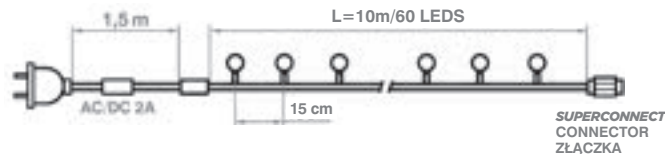

Ball LED lights - 60/100 LEDs on a 10 meter PVC cable. We offer one colour and RGB. Another product - professional outdoor lights with 2 cm in diameter with remote control and any colour combination (RGB).

Lampki Kulki LED w ilości 60/100 diod na 10-metrowym sznurze z PVC. Poza jednokolorowymi lampkami oferujemy wariant RGB. Inny rodzaj produktu - lampki zewnętrzne profesjonalne o średnicy 2 cm z pilotem i dowolną konfiguracją koloru (RGB).

LED BALL STRING LIGHTS RC PRO LAMPKI LED KULKI PRO Z PILOTEM



Power / Moc	10 W
Voltage / Zasilanie	230 V
Quantity of LEDs / Ilość diod w komplecie	60
Cable length / Długość sznura	10 m
Beam angle / Kąt świecenia	360°
Max connecting / Kompatybilność	up to 10 sets
Remote controller / Pilot	yes
Waterproof / Bryzgoszczelne	yes (IP65)
Type of cable / Rodzaj kabla	rubber 3,2mm
Type of plug / Rodzaj wtyczki	round EU

* Długość sznura może nieznacznie odbiegać od podanej w tabeli i na rysunku. Średnica kulek w nowszej wersji oświetlenia wynosi 3 cm.

Index: POL-PLSLbrm10M-RGB-G



available LED colours
dostępne kolory LED



available cable colours
dostępne kolory przewodu

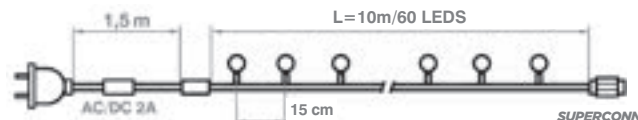

LED BIG BALLS STRING LIGHTS RC PRO LAMPKI LED KULE BOMBY PRO Z PILOTEM



Power / Moc	7,5 W
Voltage / Zasilanie	230 V
Quantity of LEDs / Ilość diod w komplecie	12
Cable length / Długość sznura	12 m
Beam angle / Kąt świecenia	360°
Max connecting / Kompatybilność	up to 10 sets
Remote controller / Pilot	yes (only with RGB)
Waterproof / Bryzgoszczelne	yes (IP65)
Type of cable / Rodzaj kabla	rubber 3,2mm
Type of plug / Rodzaj wtyczki	round EU

Index: POL-PLSLBIGb12M-CW-G POL-PLSLBIGb12M-WW-G POL-PLSLBIGb12M-RGB-G



available LED colours
dostępne kolory LED



available cable colours
dostępne kolory przewodu

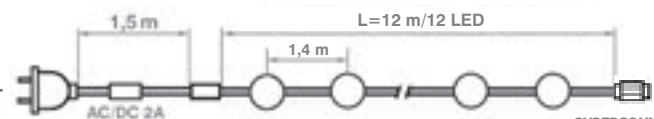

Remote controller only with RGB string lights
Pilot dostępny tylko w wersji lampek RGB

Big Christmas balls have 10 cm in diameter. We have 12 LEDs on a 10 meter cable in the gold series. Available both in white and RGB. You can connect up to 10 sets on one power supply.

Lampki LED BOMBY o średnicy 10 cm w ramach kolekcji złotej mamy 12-metrowe sznury z 12 diodami RGB lub białymi. Są kompatybilne do 10 kompletów na jednym kablu zasilającym, zatem do aż 120 metrów.



LED STRING LIGHTS - STARS LAMPKI LED Z ORNAMENTEM - GWIAZDKI



Power / Moc	6,9 W
Voltage / Zasilanie	230 V
Quantity of LEDs / Ilość diod w komplecie	100
Cable length / Długość sznura	10 m
Beam angle / Kąt świecenia	360°
Max connecting / Kompatybilność	up to 10 sets
Waterproof / Bryzgoszczelne	no (IP20)
Type of cable / Rodzaj kabla	PVC 2mm
Type of plug / Rodzaj wtyczki	flat EU

Index: POL-OLSLst10M-CW-G POL-OLSLst10M-P-G POL-OLSLst10M-G-G
 POL-OLSLst10M-WW-G POL-OLSLst10M-R-G POL-OLSLst10M-M-G
 POL-OLSLst10M-Y-G POL-OLSLst10M-BLU-G



available LED colours
dostępne kolory LED



available cable colours
dostępne kolory przewodu

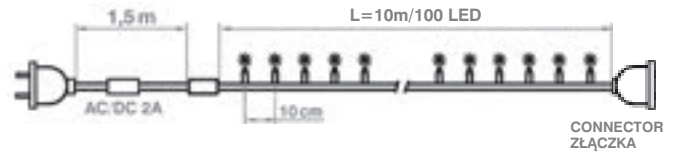

Ornament LED lights- 100 LEDs on a 10 meter cable which form flowers, stars or snowflakes. Suitable for indoor use, available in one or multicolor.

Lampki Ornamenty LED to 10-metrowe sznury po 100 lampek w kształcie kwiatka, śnieżynki lub gwiazdki. Do zastosowania wewnątrz pomieszczeń. Dostępne w jednolitych kolorach i multikolorze.



LED STRING LIGHTS - SNOWFLAKES
LAMPKI LED Z ORNAMENTEM - ŚNIEŻYNKI



Power / Moc	6,9 W
Voltage / Zasilanie	230 V
Quantity of LEDs / Ilość diod w komplecie	100
Cable length / Długość sznura	10 m
Beam angle / Kąt świecenia	360°
Max connecting / Kompatybilność	up to 10 sets
Waterproof / Bryzgoszczelne	no (IP20)
Type of cable / Rodzaj kabla	PVC 2mm
Type of plug / Rodzaj wtyczki	flat EU

Index: POL-OLSLsn10M-CW-G POL-OLSLsn10M-P-G POL-OLSLsn10M-G-G
 POL-OLSLsn10M-WW-G POL-OLSLsn10M-R-G POL-OLSLsn10M-M-G
 POL-OLSLsn10M-Y-G POL-OLSLsn10M-BLU-G



available LED colours
dostępne kolory LED



available cable colours
dostępne kolory przewodu

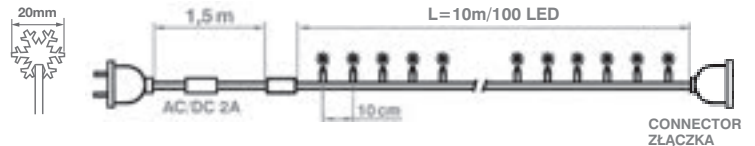

LED STRING LIGHTS - FLOWERS
LAMPKI LED Z ORNAMENTEM - KWIATKI



Power / Moc	6,9 W
Voltage / Zasilanie	230 V
Quantity of LEDs / Ilość diod w komplecie	100
Cable length / Długość sznura	10 m
Beam angle / Kąt świecenia	360°
Max connecting / Kompatybilność	up to 10 sets
Waterproof / Bryzgoszczelne	no (IP20)
Type of cable / Rodzaj kabla	PVC 2mm
Type of plug / Rodzaj wtyczki	flat EU

Index: POL-OLSLf10M-CW-G POL-OLSLf10M-P-G POL-OLSLf10M-G-G
 POL-OLSLf10M-WW-G POL-OLSLf10M-R-G POL-OLSLf10M-M-G
 POL-OLSLf10M-Y-G POL-OLSLf10M-BLU-G



available LED colours
dostępne kolory LED



available cable colours
dostępne kolory przewodu

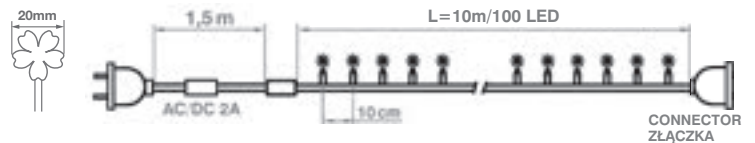

LED LIGHTS - CANDLE
LAMPKI LED ŚWIECZKI



Power / Moc	4,8 W
Voltage / Zasilanie	230 V
Quantity of LEDs / Ilość diod w komplecie	16
Cable length / Długość sznura	7,5 m
Beam angle / Kąt świecenia	360°
Waterproof / Bryzgoszczelne	no (IP20)
Type of cable / Rodzaj kabla	PVC 2mm
Type of plug / Rodzaj wtyczki	flat EU

Index: POL-16CLLUN6M-WW

available LED colours
dostępne kolory LED



available cable colours
dostępne kolory przewodu

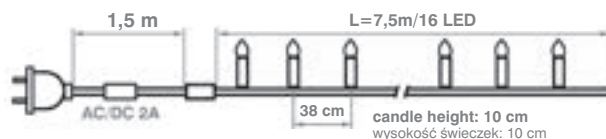

Candle LED lights, which imitate real candles. It is a perfect decoration for someone who enjoys traditional and yet more safe way of christmas decoration. There are 16 flame like LEDs on a 7,5m cable.



Lampki Świeczki LED imitujące swoim kształtem prawdziwe woskowe świeczki z odrobiną ciekącego wosku. Są efektowną dekoracją zwolenników tradycyjnego strojenia choinki a jednocześnie bardziej bezpieczną, niż otwarty ogień na drzewku. Na 7,5-metrowym sznurze umieszczono 16 diod w przezroczystych kloszach w kształcie płomienia.

TEARS STYLED LED LIGHTS RC 2m LAMPKI LED ŁEZKI Z PILOTEM 2m



Power / Moc	0,3 W
Voltage / Zasilanie	4,5 V(3xAA)
Quantity of LEDs / Ilość diod w komplecie	20
Cable length / Długość sznura	2 m
Beam angle / Kąt świecenia	360°
Remote controller / Pilot	yes (8 modes)
Waterproof / Bryzgoszczelne	no (IP20)

Index: POL-T20RC-CW POL-T20RC-BLU
POL-T20RC-WW POL-T20RC-M



BROWN SERIES

available LED colours
dostępne kolory LED



3xAA



TEARS STYLED LED LIGHTS RC 3m LAMPKI LED ŁEZKI Z PILOTEM 3m



Power / Moc	0,4 W
Voltage / Zasilanie	4,5 V(3xAA)
Quantity of LEDs / Ilość diod w komplecie	30
Cable length / Długość sznura	3 m
Beam angle / Kąt świecenia	360°
Remote controller / Pilot	yes (8 modes)
Waterproof / Bryzgoszczelne	no (IP20)

Index: POL-T30RC-CW POL-T30RC-BLU
POL-T30RC-WW POL-T30RC-M



BROWN SERIES

available LED colours
dostępne kolory LED



3xAA



Tear LED lights - we provide a couple of colour variants. There are 20 - 30 LEDs on a 2 or 3 meter cables.

Lampki łożki LED produkujemy w kilku wariantach kolorystycznych. Na sznurach o długości 2 lub 3 metrów jest odpowiednio po 20 lub 30 diod.



TEARS STYLED LED LIGHTS 2m
LAMPKI LED ŁEZKI 2m



Power / Moc	0,3 W
Voltage / Zasilanie	3 V (2xAA)
Quantity of LEDs / Ilość diod w komplecie	20
Cable length / Długość sznura	2 m
Beam angle / Kąt świecenia	360°
Waterproof / Bryzgoszczelne	no (IP20)

Index: POL-T20-CW POL-T20-BLU
POL-T20-WW POL-T20-M



**BROWN
SERIES**



TEARS STYLED LED LIGHTS 3m
LAMPKI LED ŁEZKI 3m



Power / Moc	0,4 W
Voltage / Zasilanie	3 V (2xAA)
Quantity of LEDs / Ilość diod w komplecie	30
Cable length / Długość sznura	3 m
Beam angle / Kąt świecenia	360°
Waterproof / Bryzgoszczelne	no (IP20)

Index: POL-T30-CW POL-T30-BLU
POL-T30-WW POL-T30-M



**BROWN
SERIES**

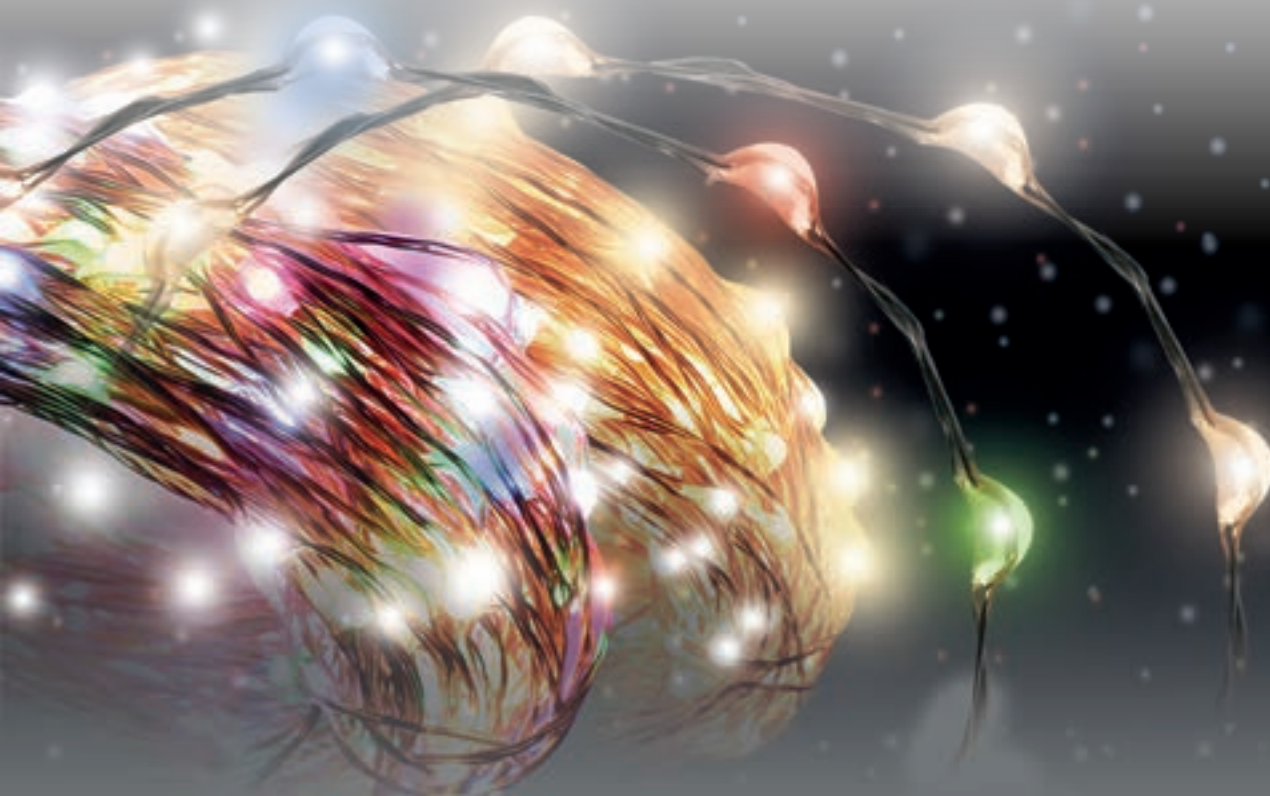



LED RATTAN BALLS 60 KULKI RATANOWE 60



Power / Moc	3,3 W
Voltage / Zasilanie	230 V
Quantity of LEDs / Ilość diod w komplecie	60
Cable length / Długość sznura	6 m
Beam angle / Kąt świecenia	360°
Waterproof / Bryzgoszczelne	no (IP20)
Type of cable / Rodzaj kabla	PVC 2mm
Type of plug / Rodzaj wtyczki	flat EU

Index: POL-RB

available LED colours
dostępne kolory LED



available cable colours
dostępne kolory przewodu



**BROWN
SERIES**

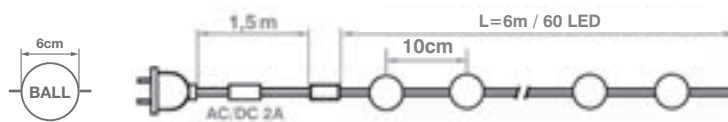

LED WOOL BALLS 10
KULKI BAWELNIANE LED 10



Power / Moc	0,6 W
Voltage / Zasilanie	2xAA
Quantity of LEDs / Ilość diod w komplecie	10
Ball diameter / Średnica kuli	6 cm
Cable length / Długość sznura	2 m
Beam angle / Kąt świecenia	360°
Waterproof / Bryzgoszczelne	no (IP20)
Type of cable / Rodzaj kabla	PVC 2mm

Index: POL-CB10-1 POL-CB10-2 POL-CB10-3



available LED colours
dostępne kolory LED



available cable colours
dostępne kolory przewodu

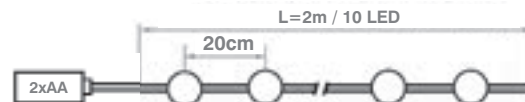

BROWN SERIES

LED WOOL BALLS 60
KULKI BAWELNIANE LED 60



Power / Moc	3,3W
Voltage / Zasilanie	230V
Quantity of LEDs / Ilość diod w komplecie	60
Ball diameter / Średnica kuli	6 cm
Cable length / Długość sznura	6 m
Beam angle / Kąt świecenia	360°
Waterproof / Bryzgoszczelne	no (IP20)
Type of cable / Rodzaj kabla	PVC 2mm
Type of plug / Rodzaj wtyczki	flat EU

Index: POL-CB



available LED colours
dostępne kolory LED



available cable colours
dostępne kolory przewodu

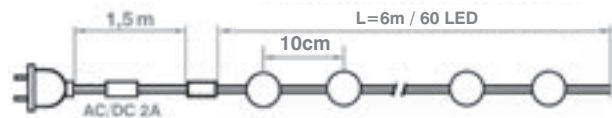

BROWN SERIES

Cotton or rattan ball lights - 10/60 multicolour LEDs on a 2/6 meter transparent PVC cable, suitable for indoor use.

Lampki kulki bawełniane lub z ratanu w ilości umieszczone są na sznurze o długości 2 lub 6 metrów i przeznaczone do zastosowań wewnątrz pomieszczeń. Kabel jest przezroczysty i wykonany w PVC.



LED WOODEN STAR WITH RC 40 cm
GWIAZDA DREWNIANA LED Z PILOTEM 40 cm



Power / Moc	0,6 W
Voltage / Zasilanie	3V (2xAA)
Quantity of LEDs / Ilość diod w komplecie	10
Star diameter / Średnica gwiazdy	40 cm
Remote controller / Pilot	yes
Waterproof / Bryzgoszczelne	no (IP20)

Index: POL-W540



INDOOR USE

BROWN SERIES

available LED colours
dostępne kolory LED



LED WOODEN STAR WITH RC 60 cm
GWIAZDA DREWNIANA LED Z PILOTEM 60 cm



Power / Moc	1,2 W
Voltage / Zasilanie	4,5V (3xAA)
Quantity of LEDs / Ilość diod w komplecie	20
Star diameter / Średnica gwiazdy	60 cm
Remote controller / Pilot	yes
Waterproof / Bryzgoszczelne	no (IP20)

Index: POL-W560



INDOOR USE

BROWN SERIES

available LED colours
dostępne kolory LED



LED WOODEN STAR WITH RC 50 cm
GWIAZDA DREWNIANA LED Z PILOTEM 50 cm



Power / Moc	0,6 W
Voltage / Zasilanie	3V (2xAA)
Quantity of LEDs / Ilość diod w komplecie	10
Star diameter / Średnica gwiazdy	50 cm
Remote controller / Pilot	yes
Waterproof / Bryzgoszczelne	no (IP20)

Index: POL-W550



INDOOR USE

BROWN SERIES

available LED colours
dostępne kolory LED



Illuminated from the inside wooden decorations. Perforated to imitate christmas ornaments. It can be used to decorating big christmas trees, windows and other indoor decorations. Set contains remote control and 2/3 AA type batteries.

Rozświetlone od wewnątrz diodami LED drewniane ozdoby z otworami w kształcie ornamentów świątecznych. Mogą mieć zastosowanie do zdobienia dużych choinek domowych, okien oraz do dowolnej aranżacji przestrzeni wewnątrz pomieszczeń. W zestawie pilot zdalnego sterowania oraz 2/3 baterie typu AA.

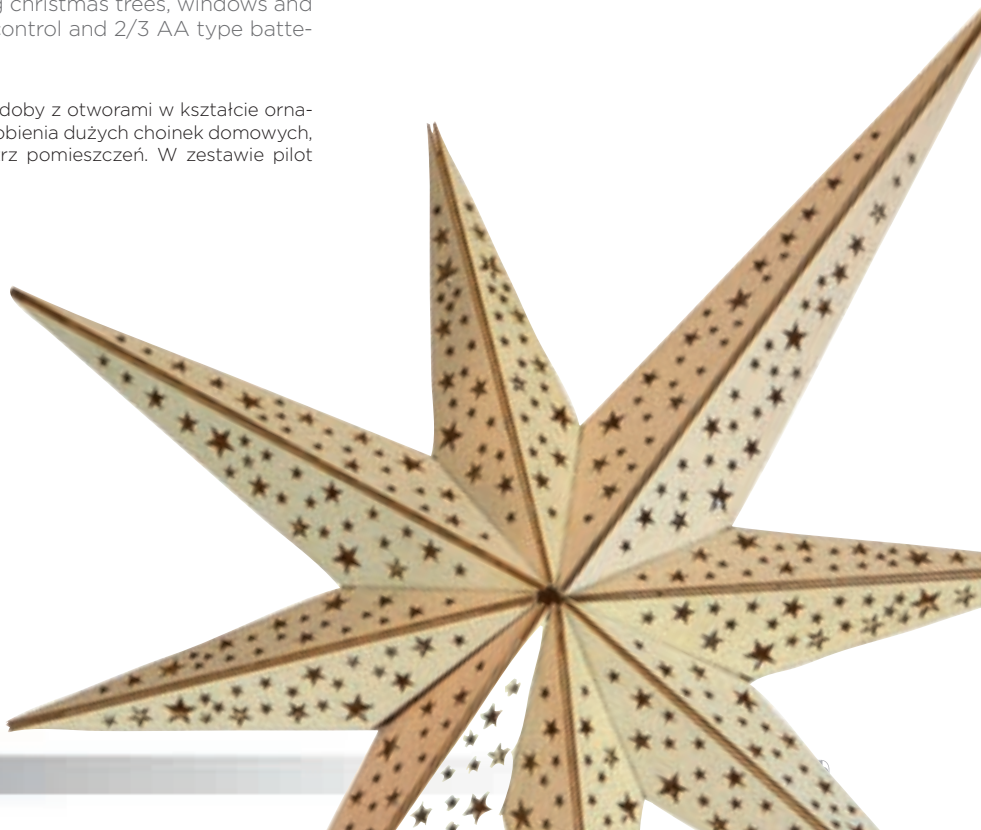



LED WOODEN STAR WITH RC 30 cm
GWIAZDA DREWNIANA LED Z PILOTEM 30 cm



Power / Moc	0,3 W
Voltage / Zasilanie	3V (2xAA)
Quantity of LEDs / Ilość diod w komplecie	10
Star diameter / Średnica gwiazdy	30 cm
Remote controller / Pilot	yes
Waterproof / Bryzgoszczelne	no (IP20)

Index: POL-WL STAR-RC-WW



available LED colours
dostępne kolory LED



LED WOODEN SLEIGH
WITH RC 45 cm
DREWNIANE SANIE LED Z PILOTEM 45 cm



Power / Moc	0,6 W
Voltage / Zasilanie	3V (2xAA)
Quantity of LEDs / Ilość diod w komplecie	10
Decoration width / Szerokość ozdoby	45 cm
Remote controller / Pilot	yes
Waterproof / Bryzgoszczelne	no (IP20)

Index: POL-WSRS



available LED colours
dostępne kolory LED



LED WOODEN CHRISTMAS TREE WITH
RC 40 cm
DREWNIANA CHOINKA Z PILOTEM 40 cm



Power / Moc	0,6 W
Voltage / Zasilanie	3V (2xAA)
Quantity of LEDs / Ilość diod w komplecie	10
Tree height / Wysokość choinki	40 cm
Remote controller / Pilot	yes
Waterproof / Bryzgoszczelne	no (IP20)

Index: POL-WCHT



available LED colours
dostępne kolory LED



LED WOODEN CRIB WITH RC 45 cm
DREWNIANA SZOPKA LED Z PILOTEM 45 cm



Power / Moc	0,6 W
Voltage / Zasilanie	3V (2xAA)
Quantity of LEDs / Ilość diod w komplecie	10
Decoration width / Szerokość ozdoby	45 cm
Remote controller / Pilot	yes
Waterproof / Bryzgoszczelne	no (IP20)

Index: POL-WC45



available LED colours
dostępne kolory LED



LED WOODEN LANTERNS WITH RC
DREWNIANE LAMPIONY LED Z PILOTEM



Power / Moc	0,6 W
Voltage / Zasilanie	3V (2xAA)
Quantity of LEDs / Ilość diod w komplecie	10
Cable length / Długość sznura	1,5 m
Remote controller / Pilot	yes
Waterproof / Bryzgoszczelne	no (IP20)

Index: POL-WLLSL



POL-WLLSL

available LED colours
dostępne kolory LED

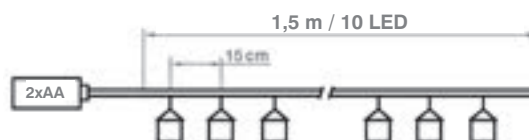

LED ROPE LIGHT REINDEER
RENIFER Z WĘŻA LED

21,6 W 230 V 160 LEDS 78 cm IP 65 A

Power / Moc	21,6 W
Voltage / Zasilanie	230V
Quantity of LEDs / Ilość diod w komplecie	160
Decoration dimensions / Wymiary dekoracji	70x78x16 cm
Waterproof / Bryzgoszczelne	yes (IP65)

Index: POL-DM

Decoration ready to use. Perfect for the garden. Solid, metal construction

Dekoracja gotowa do użycia. Idealny do ogrodu. Solidna, metalowa konstrukcja.



GOLD SERIES

available LED colours
dostępne kolory LED



LED SNOW FLAKE
WITH SNOWFALL EFFECT
ŚNIEŻYNKA LED - SPADAJĄCY ŚNIEG

6W 230 V 258 LEDS 60 cm IP 44 A

Power / Moc	6 W
Voltage / Zasilanie	230V
Quantity of LEDs / Ilość diod w komplecie	258 (90LEDS +168 smd)
Star diameter / Średnica gwiazdy	60 cm
Waterproof / Bryzgoszczelne	yes (IP44)
Power cord / Przewód zasilający	yes (30 cm white)

INDEX: POL-SNOWFLAKE60cm-CW-W



available LED colours
dostępne kolory LED



SILVER SERIES



CHRISTMAS ILLUMINATIONS

ICICLE LED CURTAINS

OŚWIETLENIE ŚWIĄTECZNE **KURTYNKI LED**

Each year, we can see more and more balconies and terraces decorated with curtains.

We produce several dozens of curtains with a wide range of color combinations. We highly recommend PVC cables. Light angle of all our LEDs is 360 degrees and lifespan of 100000 hours.

Icicle curtains available in silver outdoor series and professional gold series have the length of 2,5 + 2,5m. Overhangs from 5 meter cable have 70 cm of length. There are 120 LEDs which are placed 1 on each 10 cm. Icicle curtains are perfect for roof, ell and window decorations.

LED FLASH curtains have 120 LEDs in which 24 are FLASH LEDs. In silver series, a cable is 5 meters long with one connection in the middle which forms a set of 2,5 + 2,5m.

Professional long LED curtains - sequence of 3, 5, 5, 7, 10, 7, 5, 5, 3 with 100 cm overhang and 200 LEDs. Professional very long LED curtains: sequence of 2, 7, 13, 10, 7, 4 with 258 LEDs and 3 cable connections.

Sets can be lengthened by a special socket from 5 to 10 connected on one power supply. With this set, you can decorate your balcony or window frame. The same type of decoration can be used to decorate ceilings and roofs. The second variant can be used to decorate ells or other bigger spaces.

Our curtains have high damage endurance and is UV proof. Power supply 230V and 3.3W, in case of professional curtains - 13W. There are also 21.6W curtains available. Low power consumption gives you a big opportunity of designing your illumination without worrying about high electricity bill.

Z roku na rok coraz więcej balkonów i tarasów w przestrzeni miejskiej oraz osiedlowej, ozdabianych jest kurtynkami.

Produkujemy kilkadziesiąt modeli kurtynek z bogatą ofertą kolorystyczną, zarówno barw jednolitych, bieli, czy innych możliwości. Proponujemy kable PVC. Kąt świecenia diod 360°. Żywotność 100000 godzin świecenia.

Kurtyнки sople w serii srebrnej na zewnątrz i profesjonalne kurtyнки sople w ramach kolekcji złotej na kablu 2,5+2,5m. Zwisy z 5-metrowego sznura mają długość max 70 cm, co 10 cm rozmieszczono na nich łącznie 120 diod. Prezentują się bardzo dobrze na dachach, elewacjach, przy oknach.

Kurtyнки LED FLASH liczą 120 diod, w tym 24 diody FLASH. W kolekcji srebrnej sznur ma długość 5 metrów, profesjonalne kurtyнки są łączone na środku tworząc zestaw na 2,5+2,5 metrowym kablu.

Profesjonalne kurtyнки LED długie, bo o zwisie 100 cm mają 200 diod. Sekwencja 3, 5, 5, 7, 10, 7, 5, 5, 3. Kurtyнки bardzo długie mają 258 diod rozmieszczonych na kablu łączonym złączkami 3 razy po 1,2metra. Sekwencja 2, 7, 13, 10, 7, 4.

Zestawy można wydłużyć dołączając za pomocą opatentowanej złączki kolejne komplety, maksymalnie 5 lub 10 na jednym kablu zasilającym. W ten sposób osłanianą jest część powierzchni płyty balkonowej, czy jego oszklenia. Taką samą dekorację świetlną widuje się podwieszoną pod sufitem/dachem. Przy czym wariant długi, w odróżnieniu od standardowego, stosuje się także do zdobienia elewacji i aranżacji świetlnych w większej przestrzeni.

Jakość kurtynek i odporność na uszkodzenia oraz promieniowanie UV jest wysoka. Zasilanie 230V. Potrzebna moc to 3,3W a w przypadku profesjonalnych kurtynek długich - 13W. Dostępne są też kurtyнки o mocy 21,6W. Małe zużycie mocy pozwala projektować świąteczną (i nie tylko) iluminację świetlną, nie ryzykując wysokiego rachunku za prąd.



The SUPERCONNECT connector is weather resistant and easy to use.
Złącza SUPERCONNECT jest odporna na warunki atmosferyczne i łatwa w użyciu.



Round EU plug.
Wtyczka okrągła typu EU.



The combination of cord and sag in white version.
Połączenie sznura ze zawieszka w wersji białej.



Curtain wiring can be black or white.

Okablowanie kurtynek może być czarne lub białe.



The diodes in the curtains in gold and silver have a rubber shirt.

Diody w kurtynkach w wersji złotej i srebrnej posiadają gumową koszulkę.

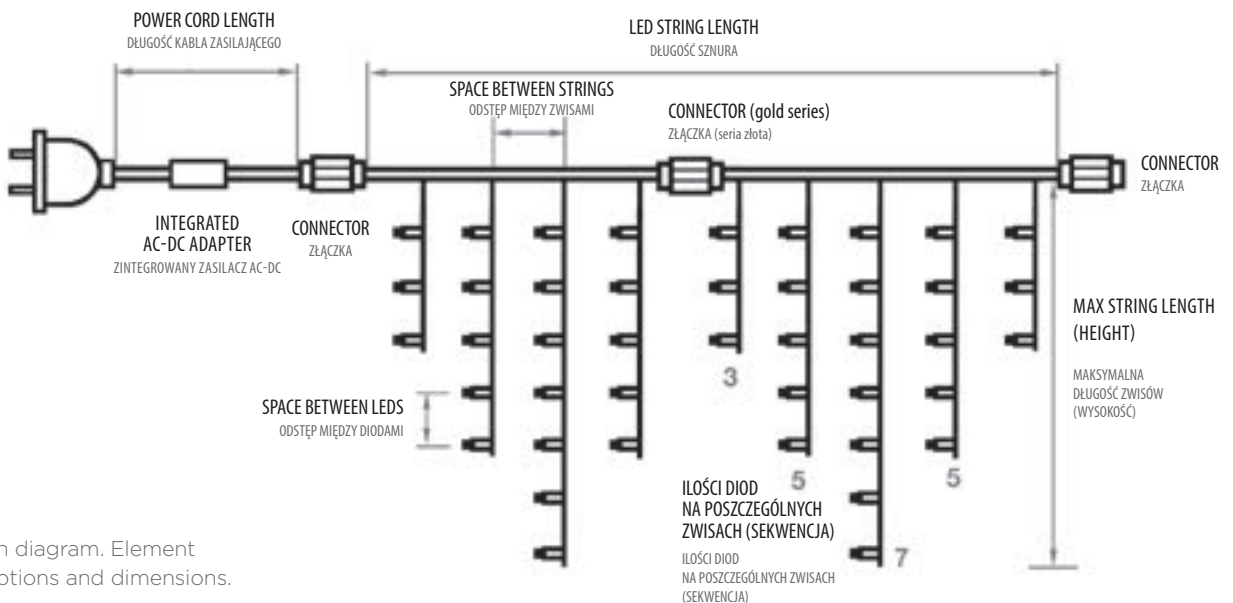

Curtain diagram. Element descriptions and dimensions.

Schemat kurtyнки. Opisy elementów i wymiarowań.



ICICLE LED CURTAINS KURTYNKI LED



Power / Moc	6,9 W
Voltage / Zasilanie	230 V
Quantity of LEDs / Ilość diod w komplecie	120
Length x Height / Długość x Wysokość	5x0,7 m
Quantity of the string / Ilość zwisów	24
Beam angle / Kąt świecenia	360°
Max connecting / Kompatybilność	up to 10 sets
Waterproof / Bryzgoszczelne	yes (IP44)
Type of cable / Rodzaj kabła	PVC 2mm
Type of plug / Rodzaj wtyczki	round EU

Index:	POL-LIL5M-CW-W	POL-LIL5M-R-BL	POL-LIL5M-G-BL
	POL-LIL5M-CW-BL	POL-LIL5M-BLUCW-W	POL-LIL5M-M-W
	POL-LIL5M-WW-W	POL-LIL5M-BLUCW-BL	POL-LIL5M-M-BL
	POL-LIL5M-WW-BL	POL-LIL5M-BLU-W	
	POL-LIL5M-Y-BL	POL-LIL5M-BLU-BL	

available LED colours
dostępne kolory LED



available cable colours
dostępne kolory przewodu



SILVER
SERIES

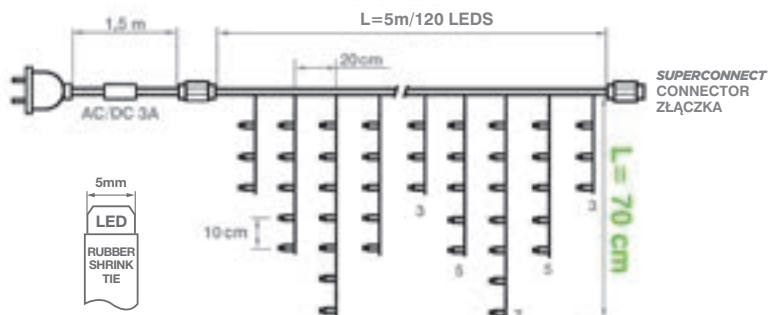

ICICLE LED CURTAINS FLASH KURTYNKI LED FLASH



Power / Moc	6,9 W
Voltage / Zasilanie	230 V
Quantity of LEDs / Ilość diod w komplecie	120
Length x Height / Długość x Wysokość	5x0,7 m
Quantity of the strings / Ilość zwisów	24
Beam angle / Kąt świecenia	360°
Max connecting / Kompatybilność	up to 10 sets
Waterproof / Bryzgoszczelne	yes (IP44)
Type of cable / Rodzaj kabła	PVC 2mm
Type of plug / Rodzaj wtyczki	round EU

Index:	POL-LILF5M-CW-W	POL-LILF5M-WW-W	POL-LILF5M-BLU-W
	POL-LILF5M-CW-BL	POL-LILF5M-WW-BL	POL-LILF5M-BLU-BL

available LED colours
dostępne kolory LED



available cable colours
dostępne kolory przewodu



96 LEDs + 24 LEDs FLASH cold white
96 LED + 24 LED FLASH białych zimnych



SILVER
SERIES

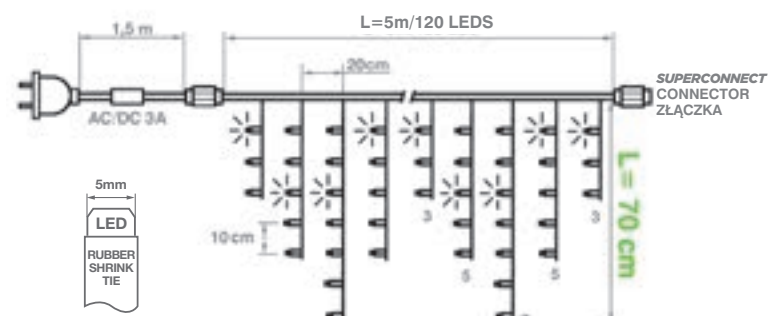

ICICLE LED CURTAINS PRO
KURTYNKI LED PRO



Power / Moc	9,2 W
Voltage / Zasilanie	230 V
Quantity of LEDs / Ilość diod w komplecie	120
Length x Height / Długość x Wysokość	5x0,7 m
Quantity of the strings / Ilość zwisów	24
Beam angle / Kąt świecenia	360°
Max connecting / Kompatybilność	up to 10 sets
Waterproof / Bryzgoszczelne	yes (IP65)
Type of cable / Rodzaj kabla	rubber 3,2mm
Type of plug / Rodzaj wtyczki	round EU

Index:	POL-PLIL5M-CW-W	POL-PLIL5M-R-BL	POL-PLIL5M-G-W
	POL-PLIL5M-CW-BL	POL-PLIL5M-CWBLU-W	POL-PLIL5M-G-BL
	POL-PLIL5M-WW-W	POL-PLIL5M-CWBLU-BL	POL-PLIL5M-M-W
	POL-PLIL5M-WW-BL	POL-PLIL5M-BLU-W	POL-PLIL5M-M-BL
	POL-PLIL5M-Y-BL	POL-PLIL5M-BLU-BL	

available LED colours
dostępne kolory LED



available cable colours
dostępne kolory przewodu



GOLD SERIES

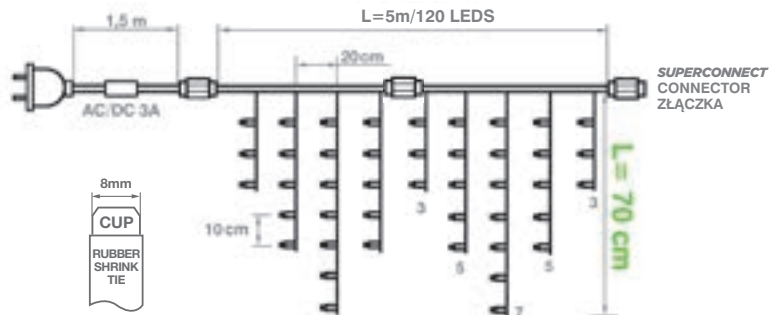

ICICLE LED CURTAINS PRO FLASH
KURTYNKI LED PRO FLASH



Power / Moc	9,2 W
Voltage / Zasilanie	230 V
Quantity of LEDs / Ilość diod w komplecie	120
Length x Height / Długość x Wysokość	5x0,7 m
Quantity of the strings / Ilość zwisów	24
Beam angle / Kąt świecenia	360°
Max connecting / Kompatybilność	up to 10 sets
Waterproof / Bryzgoszczelne	yes (IP65)
Type of cable / Rodzaj kabla	rubber 3,2mm
Type of plug / Rodzaj wtyczki	round EU

Index:	POL-PLIL5M-CW-W	POL-PLIL5M-WW-W	POL-PLIL5M-BLU-W
	POL-PLIL5M-CW-BL	POL-PLIL5M-WW-BL	POL-PLIL5M-BLU-BL

available LED colours
dostępne kolory LED



available cable colours
dostępne kolory przewodu



96 LEDs + 24 LEDs FLASH cold white
96 LED + 24 LED FLASH białych zimnych



GOLD SERIES

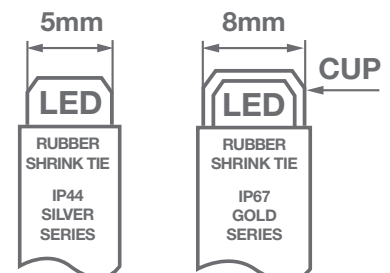
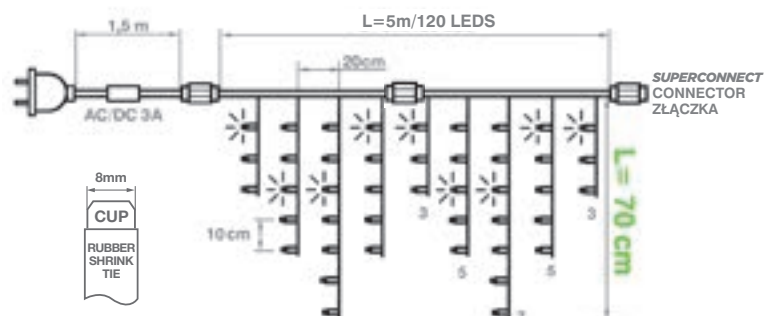

The diodes in the curtains (silver and gold series) have a rubber shirt and 8mm cup in gold series.

Diody w kurtynkach z serii srebrnej i złotej posiadają gumową koszulkę, a w serii złotej dodatkowo obudowę 8 mm.



ICICLE LONG LED CURTAINS PRO KURTYNKI DŁUGIE LED PRO



Power / Moc	18,4 W
Voltage / Zasilanie	230 V
Quantity of LEDs / Ilość diod w komplecie	200
Length x Height / Długość x Wysokość	5(2,5+2,5)x1 m
Quantity of the strings / Ilość zwisów	36
Beam angle / Kąt świecenia	360°
Max connecting / Kompatybilność	up to 5 sets
Waterproof / Bryzgoszczelne	yes (IP65)
Type of cable / Rodzaj kabla	rubber 3,2mm
Type of plug / Rodzaj wtyczki	round EU

Index: POL-PLLIL5M-CW-W POL-PLLIL5M-WW-W
POL-PLLIL5M-CW-BL POL-PLLIL5M-WW-BL

available LED colours
dostępne kolory LED



available cable colours
dostępne kolory przewodu



OUTDOOR USE

**GOLD
SERIES**

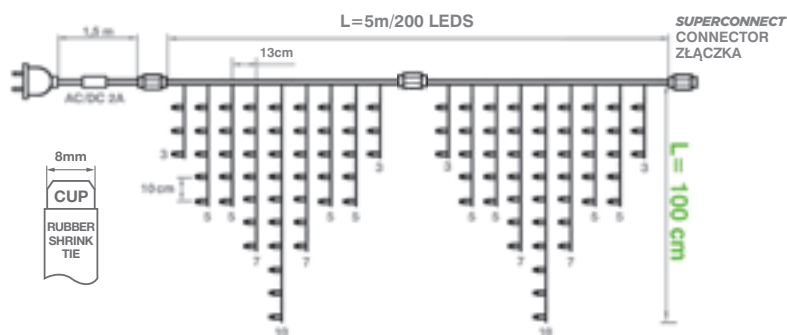

ICICLE LONG LED CURTAINS PRO FLASH KURTYNKI DŁUGIE LED PRO FLASH



Power / Moc	18,4 W
Voltage / Zasilanie	230 V
Quantity of LEDs / Ilość diod w komplecie	200
Length x Height / Długość x Wysokość	5(2,5+2,5)x1 m
Quantity of the strings / Ilość zwisów	36
Beam angle / Kąt świecenia	360°
Max connecting / Kompatybilność	up to 5 sets
Waterproof / Bryzgoszczelne	yes (IP65)
Type of cable / Rodzaj kabla	rubber 3,2mm
Type of plug / Rodzaj wtyczki	round EU

Index: POL-PLLIF5M-CW-W POL-PLLIF5M-WW-W
POL-PLLIF5M-CW-BL POL-PLLIF5M-WW-BL

available LED colours
dostępne kolory LED



available cable colours
dostępne kolory przewodu



OUTDOOR USE

**GOLD
SERIES**

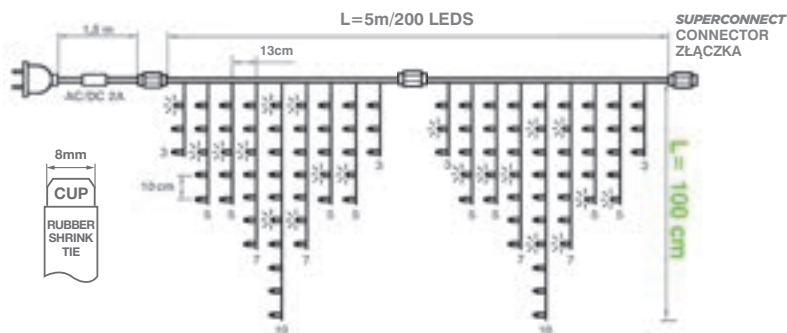

152 LEDs + 48 LEDs FLASH cold white
152 LED + 48 LED FLASH białych zimnych

ICICLE VERY LONG LED CURTAINS PRO FLASH
KURTYNKI BARDZO DŁUGIE LED PRO FLASH



Power / Moc	18,4 W
Voltage / Zasilanie	230 V
Quantity of LEDs / Ilość diod w komplecie	258
Length x Height / Długość x Wysokość	3,6(3x1,2)x1,3 m
Quantity of the strings / Ilość zwisów	36
Beam angle / Kąt świecenia	360°
Max connecting / Kompatybilność	up to 10 sets
Waterproof / Bryzgoszczelne	yes (IP65)
Type of cable / Rodzaj kabla	rubber 3,2mm
Type of plug / Rodzaj wtyczki	round EU

Index: POL-PLLILF3,6M-CW-W POL-PLLILF3,6M-WW-W
 POL-PLLILF3,6M-CW-BL POL-PLLILF3,6M-WW-BL



207 LEDs + 51 LEDs FLASH cold white
 207 LED + 51 LED FLASH białych zimnych

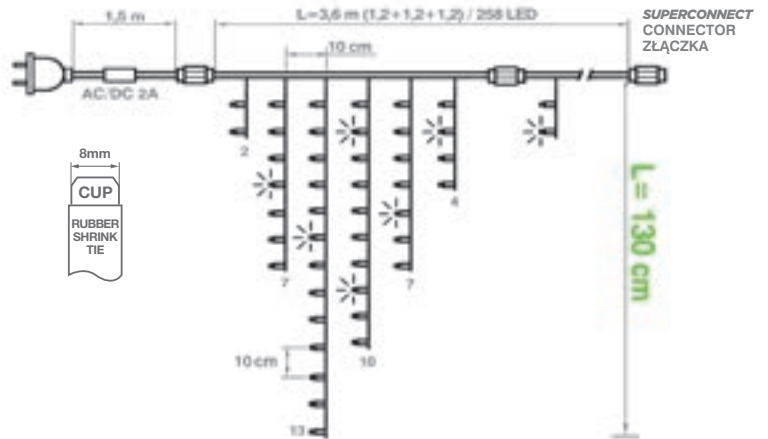

ICICLE STAR LED CURTAINS
KURTYNKI GWIAZDKI LED



Power / Moc	3,6 W
Voltage / Zasilanie	230 V
Quantity of LEDs / Ilość diod w komplecie	100
Length x Height / Długość x Wysokość	2x0,7 m
Quantity of the strings / Ilość zwisów	20
Beam angle / Kąt świecenia	360°
Waterproof / Bryzgoszczelne	no (IP20)
Type of cable / Rodzaj kabla	PVC 2mm
Type of plug / Rodzaj wtyczki	flat EU

Index: POL-LILINSTAR-WW-T POL-LILINSTAR-CW-T

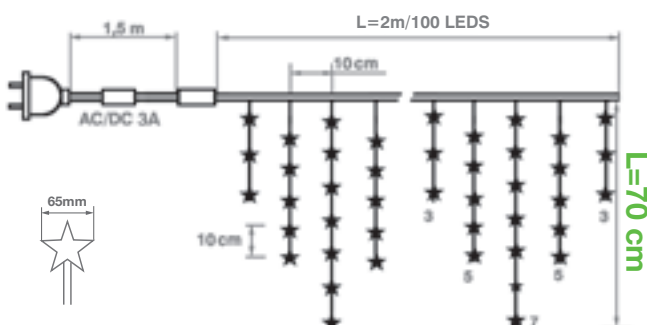

CHRISTMAS ILLUMINATIONS

LED CURTAINS

OŚWIETLENIE ŚWIĄTECZNE **KURTYNY LED**

Led curtains are one of the energy - saving illumination products made by POLAMP. Suitable for designing christmas illuminations. Unlike smaller curtains, these have equal length LED light cables.

We produce several dozen curtain models. There are several sizes in the silver series available : 5x0.5m with 240 LEDs on a PVC cable, 5x1m with 400 LEDs, 2.5x1m with 380 LEDs, 2.5x3m with 600 and 720 LEDs. The biggest set has 2.5x9m with 1000 LEDs.

A little bit different sizes have LED FLASH curtains which can be standard or professional in gold series. You can have 5x0.5m with 240 LEDs, 5x1m or 2.5x1.5m with 380 LEDs and 2.5x3m with 560 LEDs. Overhangs can have 6m long curtains with 720 LEDs or 9m long with 1000 LEDs.

We also have waterfall effect products in our gold and silver series. In both collections, length and LED amount are the same. For 2.5x3m length we provided 720 LEDs and for 2.5x6m - 1440 LEDs.

Power cables for all the curtains can be joint by a special socket, which can allow you to connect together up to 10 sets. Each LED used in our illuminations has a lifespan of 100000 hours. All the LEDs are also splash-proof.

We recommend to use our curtains to ell, tree, and christmas tree illumination. Waterfall effect LEDs can be also used to illuminate fountains during the winter. Our LEDs are snow, temperature and UV proof. Moreover our LEDs have low heat emission.

We want to wish you a nice illumination design. We also want to inform that we help in project visualization, installation and maintenance.

Kurtyny LED to jeden z energooszczędnych produktów oświetleniowych POLAMP, dedykowany przede wszystkim do komponowania świątecznych iluminacji. W odróżnieniu od kurtynek zwieszane z kabla zasilającego sznury z lampkami LED są równej długości.

Produkujemy kilkadziesiąt modeli kurtyń. Dostępne rozmiary produktów serii srebrnej to 5x0,5m z 240 diodami na kablu PVC. Poza tym 5x1m z 400 diodami, 2,5x1,5m z 380 diodami. 600 diod mają kurtyny o wymiarach 2,5x3m a 720 - 2,5x6m. Najwięcej źródeł światła, bo aż 1000 diod mają kurtyny 2,5x9m.

Nieco inne wymiary mają kurtyny LED FLASH oraz profesjonalne kurtyny LED standardowe oraz FLASH w serii złotej. Na sznurach 5x0,5m jest 240 diod. Po 380 diod mają kurtyny 5x1m albo 2,5x1,5m. 560 diod dla kurtyny o wymiarach 2,5x3m. Zwisy na 2,5 metra mają też kurtyny o długości 6m z 720 diodami oraz o długości 9m, gdzie jest 1000 diod LED.

Mamy też, w ramach serii złotej i srebrnej, linię produktów z widowiskowym efektem wodospadu. W obu kolekcjach rozmiary, jak i ilości diod są takie same. Dla wielkości 2,5x3m przewidzieliśmy 720 diod a dla 2,5x6m - 1440 źródeł światła.

Kable zasilające wszystkich kurtyń można ze sobą łączyć za pomocą opatentowanej złączki, wówczas wydłużysz zestaw maksymalnie do 10 kompletów. Żywotność diod LED wykorzystanych w każdej kurtyńce, szacujemy na 100000 godzin świecenia. Z pewnością ma na to wpływ ich tzw. bryzgoszczelność.

Proponujemy zastosowanie kurtyń do oświetlenia elewacji, drzew, a także choinek. Komplet z diodami Waterfall doskonale nadają się do ozdobienia, wyłączonych na sezon zimowy, fontann. Nasze lampki są odporne na niskie temperatury, promieniowanie UV, uszkodzenia i sprawnie działają nawet przy dużej wilgotności. Przy tym mają niską emisję ciepła.





Round EU plug.
Wtyczka okrągła typu EU.

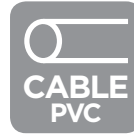

The SUPERCONNECT connector is weather resistant and easy to use.
Złączka SUPERCONNECT jest odporna na warunki atmosferyczne i łatwa w użyciu.



Connection of rope with string.
Połączenie sznura ze zwisem.



A splitter for connecting curtains.
Rozgałęźnik do łączenia kurtyn.



The diodes in the curtains have a rubber shirt and 8mm cup in gold series.

Diody w kurtynach posiadają gumową koszulkę, a w serii złotej dodatkowo obudowę 8 mm.

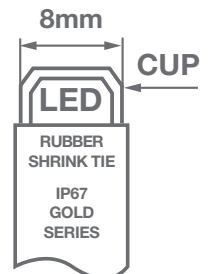

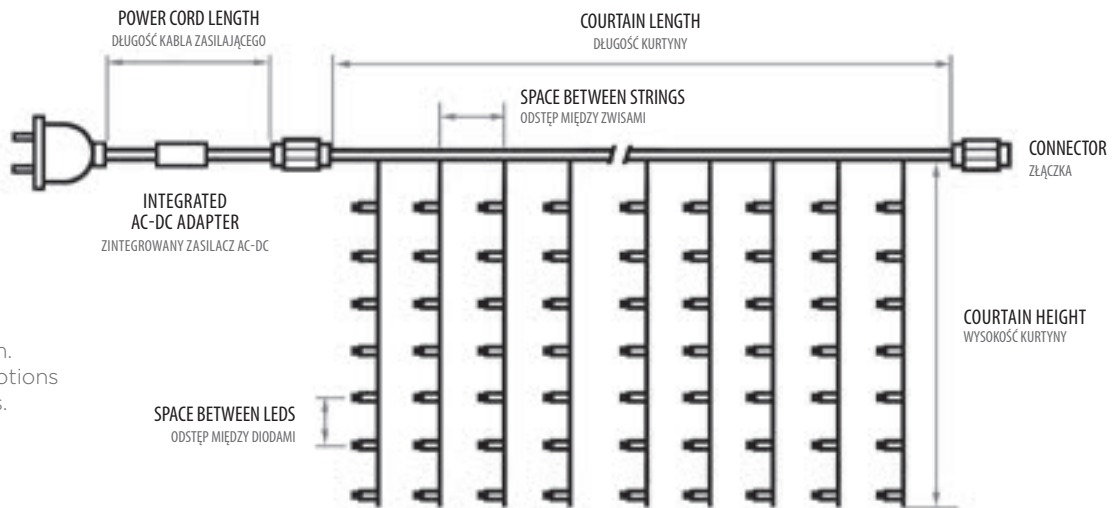

Curtain diagram.
Element descriptions
and dimensions.

Schemat kurtyny.
Opisy elementów
i wymiarowań.

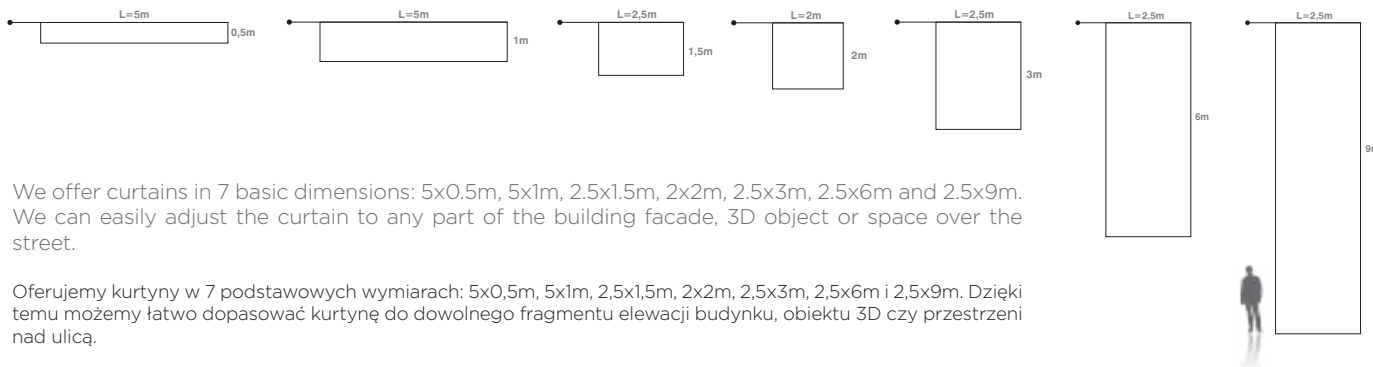

We offer curtains in 7 basic dimensions: 5x0.5m, 5x1m, 2.5x1.5m, 2x2m, 2.5x3m, 2.5x6m and 2.5x9m. We can easily adjust the curtain to any part of the building facade, 3D object or space over the street.

Oferujemy kurtyny w 7 podstawowych wymiarach: 5x0,5m, 5x1m, 2,5x1,5m, 2x2m, 2,5x3m, 2,5x6m i 2,5x9m. Dzięki temu możemy łatwo dopasować kurtyne do dowolnego fragmentu elewacji budynku, obiektu 3D czy przestrzeni nad ulicą.



Curtains are used not only for facades buildings but also when decorating large 3D decorations, e.g. as filling of sails in a sailing ship.

Kurtyny znajdują zastosowanie nie tylko przy elewacjach budynków ale także przy zdobieniu dużych dekoracji 3D, np. jako wypełnienie żagli w żaglowcu.



LED CURTAINS 5X0,5m KURTYNY LED 5x0,5m



Power / Moc	13,8 W
Voltage / Zasilanie	230 V
Quantity of LEDs / Ilość diod w komplecie	240
Length x Height / Długość x Wysokość	5x0,5 m
Quantity of the strings / Ilość zwisów	48
Beam angle / Kąt świecenia	360°
Max connecting / Kompatybilność	up to 5 sets
Waterproof / Bryzgoszczelne	yes (IP44)
Type of cable / Rodzaj kabla	PVC 2mm
Type of plug / Rodzaj wtyczki	round EU

Index: POL-LCL5X0,5-CW-T POL-LCL5X0,5-WW-T

available LED colours
dostępne kolory LED



available cable colours
dostępne kolory przewodu



SILVER SERIES

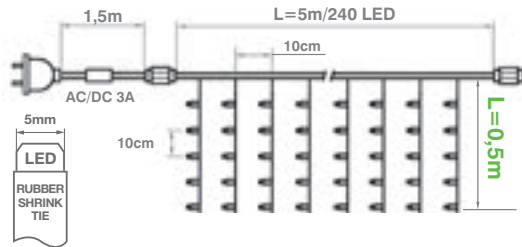

SUPERCONNECT CONNECTOR ZŁĄCZKA

LED CURTAINS 5X1m KURTYNY LED 5x1m



Power / Moc	27,6 W
Voltage / Zasilanie	230 V
Quantity of LEDs / Ilość diod w komplecie	400
Length x Height / Długość x Wysokość	5x1 m
Quantity of the strings / Ilość zwisów	40
Beam angle / Kąt świecenia	360°
Max connecting / Kompatybilność	up to 4 sets
Waterproof / Bryzgoszczelne	yes (IP44)
Type of cable / Rodzaj kabla	PVC 2mm
Type of plug / Rodzaj wtyczki	round EU

Index: POL-LCL5X1,0-CW-T POL-LCL5X1,0-WW-T

available LED colours
dostępne kolory LED



available cable colours
dostępne kolory przewodu



SILVER SERIES

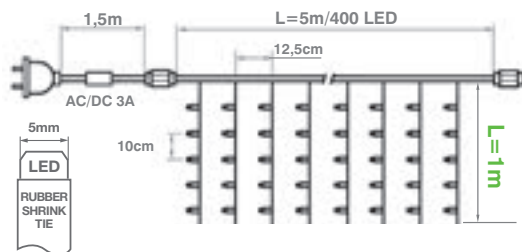

SUPERCONNECT CONNECTOR ZŁĄCZKA

LED CURTAINS 2,5X1,5m KURTYNY LED 2,5x1,5m



Power / Moc	69 W
Voltage / Zasilanie	230 V
Quantity of LEDs / Ilość diod w komplecie	380
Length x Height / Długość x Wysokość	2,5x1,5 m
Quantity of the strings / Ilość zwisów	20
Beam angle / Kąt świecenia	360°
Max connecting / Kompatybilność	up to 4 sets
Waterproof / Bryzgoszczelne	yes (IP44)
Type of cable / Rodzaj kabla	PVC 2mm
Type of plug / Rodzaj wtyczki	round EU

Index: POL-LCL2,5X1,5-CW-T POL-LCL2,5X1,5-WW-T

available LED colours
dostępne kolory LED



available cable colours
dostępne kolory przewodu



SILVER SERIES

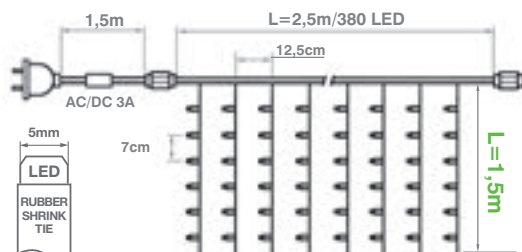

SUPERCONNECT CONNECTOR ZŁĄCZKA



LED CURTAINS 2,5X3m KURTINY LED 2,5x3m



Power / Moc	69 W
Voltage / Zasilanie	230 V
Quantity of LEDs / Ilość diod w komplecie	600
Length x Height / Długość x Wysokość	2,5x3 m
Quantity of the strings / Ilość zwisów	20
Beam angle / Kąt świecenia	360°
Max connecting / Kompatybilność	up to 4 sets
Waterproof / Bryzgoszczelne	yes (IP44)
Type of cable / Rodzaj kabla	PVC 2mm
Type of plug / Rodzaj wtyczki	round EU

Index: POL-LCL2,5X3,0-CW-T POL-LCL2,5X3,0-WW-T

available LED colours
dostępne kolory LED



available cable colours
dostępne kolory przewodu



SILVER
SERIES

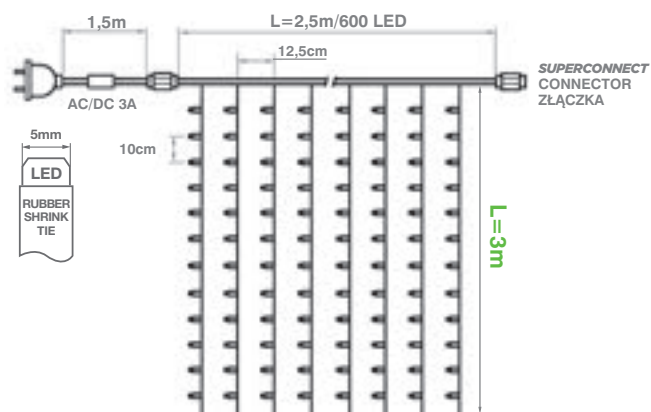

LED CURTAINS 2,5X6m KURTYNY LED 2,5x6m



Power / Moc	69 W
Voltage / Zasilanie	230 V
Quantity of LEDs / Ilość diod w komplecie	720
Length x Height / Długość x Wysokość	2,5x6 m
Quantity of the strings / Ilość zwisów	20
Beam angle / Kąt świecenia	360°
Max connecting / Kompatybilność	up to 4 sets
Waterproof / Bryzgoszczelne	yes (IP44)
Type of cable / Rodzaj kabla	PVC 2mm
Type of plug / Rodzaj wtyczki	round EU

Index: POL-LCL2,5X6,0-CW-T POL-LCL2,5X6,0-WW-T



available LED colours
dostępne kolory LED



available cable colours
dostępne kolory przewodu



SILVER
SERIES

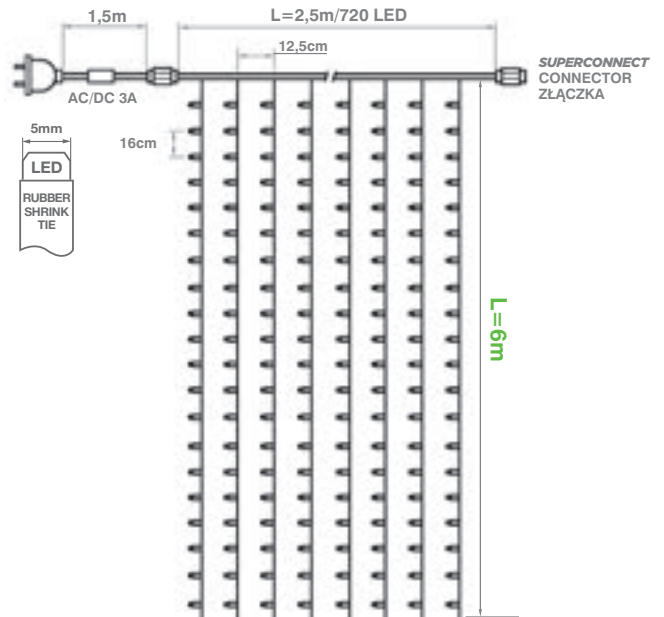

LED CURTAINS 2,5X9m KURTYNY LED 2,5x9m



Power / Moc	69 W
Voltage / Zasilanie	230 V
Quantity of LEDs / Ilość diod w komplecie	1000
Length x Height / Długość x Wysokość	2,5x9 m
Quantity of the strings / Ilość zwisów	20
Beam angle / Kąt świecenia	360°
Max connecting / Kompatybilność	up to 1 sets
Waterproof / Bryzgoszczelne	yes (IP44)
Type of cable / Rodzaj kabla	PVC 2mm
Type of plug / Rodzaj wtyczki	round EU

Index: POL-LCL2,5X9,0-CW-T POL-LCL2,5X9,0-WW-T



available LED colours
dostępne kolory LED



available cable colours
dostępne kolory przewodu



SILVER
SERIES

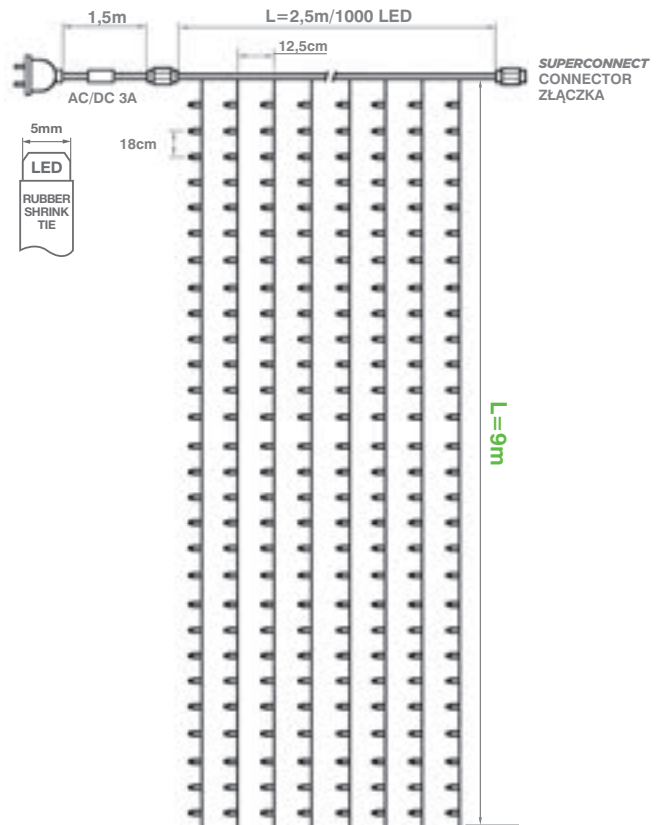

LED CURTAINS 5X0,5m FLASH
KURTYNY LED 5x0,5m FLASH



Power / Moc	13,8 W
Voltage / Zasilanie	230 V
Quantity of LEDs / Ilość diod w komplecie	240
Length x Height / Długość x Wysokość	5x0,5 m
Quantity of the strings / Ilość zwisów	48
Beam angle / Kąt świecenia	360°
Max connecting / Kompatybilność	up to 5 sets
Waterproof / Bryzgoszczelne	yes (IP44)
Type of cable / Rodzaj kabla	PVC 2mm
Type of plug / Rodzaj wtyczki	round EU

Index: POL-LCLF5X0,5-CW-T POL-LCLF5X0,5-WW-T

192 LEDs + 48 LEDs FLASH cold white
192 LED + 48 LED FLASH białych zimnych



available LED colours
dostępne kolory LED



available cable colours
dostępne kolory przewodu

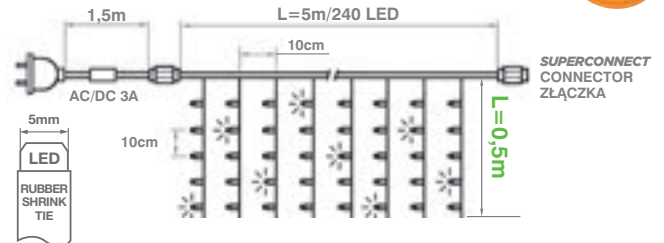

LED CURTAINS 5X1m FLASH
KURTYNY LED 5x1m FLASH



Power / Moc	27,6 W
Voltage / Zasilanie	230 V
Quantity of LEDs / Ilość diod w komplecie	400
Length x Height / Długość x Wysokość	5x1 m
Quantity of the strings / Ilość zwisów	40
Beam angle / Kąt świecenia	360°
Max connecting / Kompatybilność	up to 4 sets
Waterproof / Bryzgoszczelne	yes (IP44)
Type of cable / Rodzaj kabla	PVC 2mm
Type of plug / Rodzaj wtyczki	round EU

Index: POL-LCLF5X1,0-CW-T POL-LCLF5X1,0-WW-T

320 LEDs + 80 LEDs FLASH cold white
320 LED + 80 LED FLASH białych zimnych



available LED colours
dostępne kolory LED



available cable colours
dostępne kolory przewodu

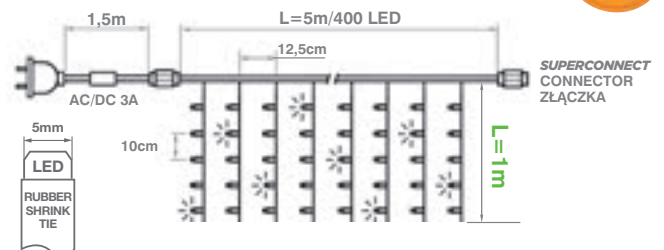

LED CURTAINS 2,5X1,5m FLASH
KURTYNY LED 2,5x1,5m FLASH



Power / Moc	69 W
Voltage / Zasilanie	230 V
Quantity of LEDs / Ilość diod w komplecie	380
Length x Height / Długość x Wysokość	2,5x1,5 m
Quantity of the strings / Ilość zwisów	20
Beam angle / Kąt świecenia	360°
Max connecting / Kompatybilność	up to 4 sets
Waterproof / Bryzgoszczelne	yes (IP44)
Type of cable / Rodzaj kabla	PVC 2mm
Type of plug / Rodzaj wtyczki	round EU

Index: POL-LCLF2,5X1,5-CW-T POL-LCLF2,5X1,5-WW-T

304 LEDs + 76 LEDs FLASH cold white
304 LED + 76 LED FLASH białych zimnych



available LED colours
dostępne kolory LED



available cable colours
dostępne kolory przewodu

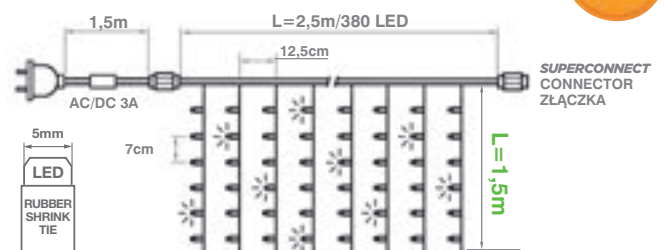

LED CURTAINS 2,5X3m FLASH KURTYNY LED 2,5x3m FLASH



Power / Moc	69 W
Voltage / Zasilanie	230 V
Quantity of LEDs / Ilość diod w komplecie	600
Length x Height / Długość x Wysokość	2,5x3 m
Quantity of the strings / Ilość zwisów	20
Beam angle / Kąt świecenia	360°
Max connecting / Kompatybilność	up to 4 sets
Waterproof / Bryzgoszczelne	yes (IP44)
Type of cable / Rodzaj kabla	PVC 2mm
Type of plug / Rodzaj wtyczki	round EU

Index: POL-LCLf2,5X3,0-CW-T POL-LCLf2,5X3,0-WW-T

available LED colours
dostępne kolory LED



available cable colours
dostępne kolory przewodu



480 LEDs + 120 LEDs FLASH cold white
480 LED +120 LED FLASH białych zimnych



SILVER SERIES

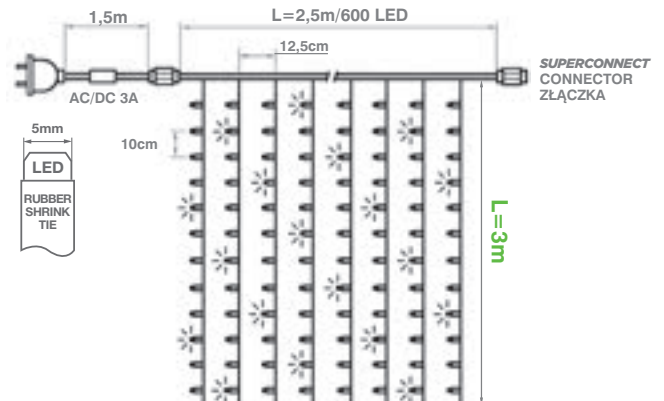

Connector for connecting the curtain cord with a string.
Złączka do łączenia sznura kurtyny ze zwisem.



LED CURTAINS 2,5X6m FLASH
KURTYNY LED 2,5x6m FLASH



Power / Moc	69 W
Voltage / Zasilanie	230 V
Quantity of LEDs / Ilość diod w komplecie	720
Length x Height / Długość x Wysokość	2,5x6 m
Quantity of the strings / Ilość zwisów	20
Beam angle / Kąt świecenia	360°
Max connecting / Kompatybilność	up to 4 sets
Waterproof / Bryzgoszczelne	yes (IP44)
Type of cable / Rodzaj kabla	PVC 2mm
Type of plug / Rodzaj wtyczki	round EU

Index: POL-LCLF2,5X6,0-CW-T POL-LCLF2,5X6,0-WW-T



available LED colours
dostępne kolory LED



available cable colours
dostępne kolory przewodu



SILVER SERIES



576 LEDs + 144 LEDs FLASH cold white
576 LED +144 LED FLASH białych zimnych

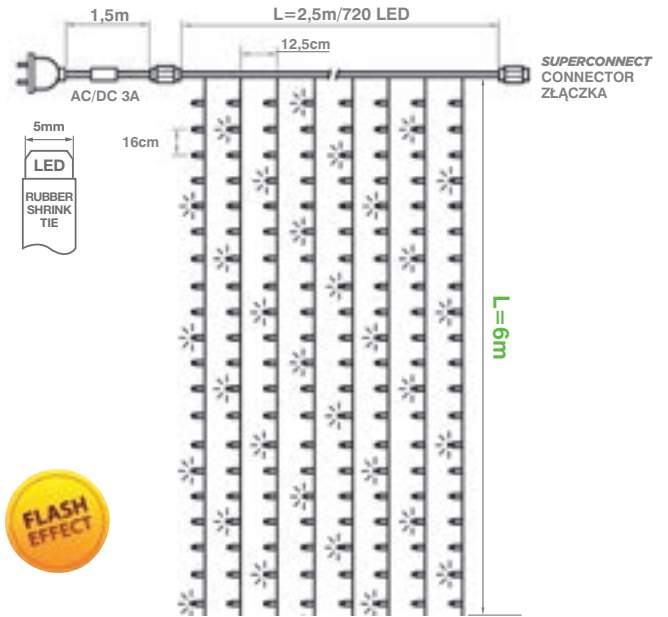

LED CURTAINS 2,5X9m FLASH
KURTYNY LED 2,5x9m FLASH



Power / Moc	69 W
Voltage / Zasilanie	230 V
Quantity of LEDs / Ilość diod w komplecie	1000
Length x Height / Długość x Wysokość	2,5x9 m
Quantity of the strings / Ilość zwisów	20
Beam angle / Kąt świecenia	360°
Max connecting / Kompatybilność	up to 1 sets
Waterproof / Bryzgoszczelne	yes (IP44)
Type of cable / Rodzaj kabla	PVC 2mm
Type of plug / Rodzaj wtyczki	round EU

Index: POL-LCLF2,5X9,0-CW-T POL-LCLF2,5X9,0-WW-T



available LED colours
dostępne kolory LED



available cable colours
dostępne kolory przewodu



SILVER SERIES



800 LEDs + 200 LEDs FLASH cold white
800 LED +200 LED FLASH białych zimnych

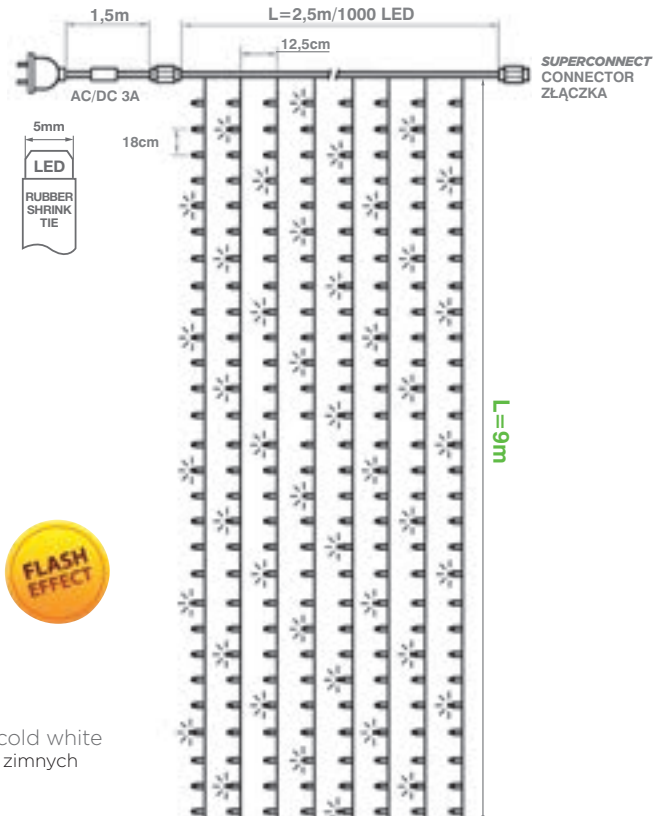

LED CURTAINS 5X0,5m PRO KURTYNY LED 5x0,5m PRO



Power / Moc	18,4 W
Voltage / Zasilanie	230 V
Quantity of LEDs / Ilość diod w komplecie	240
Length x Height / Długość x Wysokość	5x0,5 m
Quantity of the strings / Ilość zwisów	48
Beam angle / Kąt świecenia	360°
Max connecting / Kompatybilność	up to 5 sets
Waterproof / Bryzgoszczelne	yes (IP65)
Type of cable / Rodzaj kabla	rubber 3mm
Type of plug / Rodzaj wtyczki	round EU

Index: POL-PLCL5X0,5-CW-BL POL-PLCL5X0,5-WW-BL
POL-PLCL5X0,5-CW-W POL-PLCL5X0,5-WW-W



available LED colours
dostępne kolory LED



available cable colours
dostępne kolory przewodu

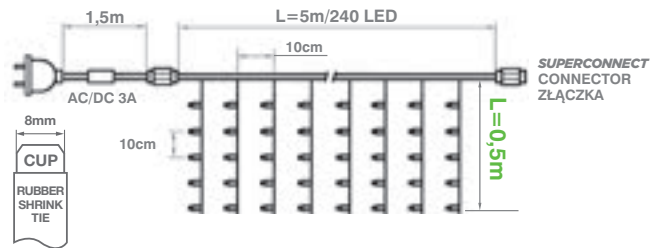

LED CURTAINS 5X1m PRO KURTYNY LED 5x1m PRO



Power / Moc	36,8 W
Voltage / Zasilanie	230 V
Quantity of LEDs / Ilość diod w komplecie	400
Length x Height / Długość x Wysokość	5x1 m
Quantity of the strings / Ilość zwisów	40
Beam angle / Kąt świecenia	360°
Max connecting / Kompatybilność	up to 4 sets
Waterproof / Bryzgoszczelne	yes (IP65)
Type of cable / Rodzaj kabla	rubber 3mm
Type of plug / Rodzaj wtyczki	round EU

Index: POL-PLCL5X1,0-CW-W POL-PLCL5X1,0-WW-W
POL-PLCL5X1,0-CW-BL POL-PLCL5X1,0-WW-BL



available LED colours
dostępne kolory LED



available cable colours
dostępne kolory przewodu

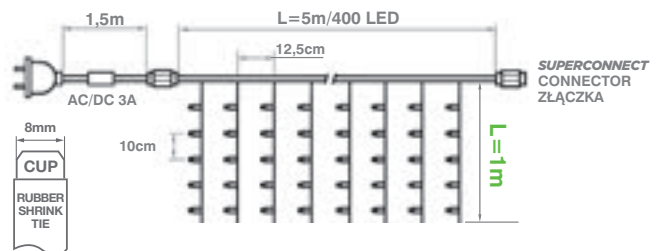

LED CURTAINS 2,5X1,5M PRO KURTYNY LED 2,5x1,5m PRO



Power / Moc	92 W
Voltage / Zasilanie	230 V
Quantity of LEDs / Ilość diod w komplecie	380
Length x Height / Długość x Wysokość	2,5x1,5 m
Quantity of the strings / Ilość zwisów	20
Beam angle / Kąt świecenia	360°
Max connecting / Kompatybilność	up to 4 sets
Waterproof / Bryzgoszczelne	yes (IP65)
Type of cable / Rodzaj kabla	rubber 3mm
Type of plug / Rodzaj wtyczki	round EU

Index: POL-PLCL2,5X1,5-CW-W POL-PLCL2,5X1,5-WW-W POL-PLCL2,5X1,5-BLU-W
POL-PLCL2,5X1,5-CW-BL POL-PLCL2,5X1,5-WW-BL POL-PLCL2,5X1,5-BLU-BL



available LED colours
dostępne kolory LED

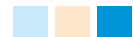

available cable colours
dostępne kolory przewodu

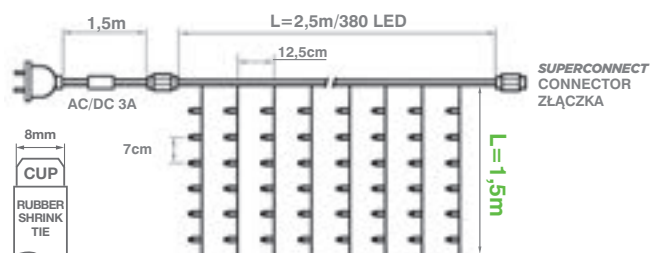

LED CURTAINS 2X2m PRO
KURTYNY LED 2x2m PRO



Power / Moc	92 W
Voltage / Zasilanie	230 V
Quantity of LEDs / Ilość diod w komplecie	400
Length x Height / Długość x Wysokość	2x2 m
Quantity of the strings / Ilość zwisów	20
Beam angle / Kąt świecenia	360°
Max connecting / Kompatybilność	up to 6 sets
Waterproof / Bryzgoszczelne	yes (IP65)
Type of cable / Rodzaj kabla	PVC 3mm
Type of plug / Rodzaj wtyczki	round EU

Index: POL-PLCL2x2-CW-G POL-PLCL2x2-WW-G

available LED colours
dostępne kolory LED



available cable colours
dostępne kolory przewodu

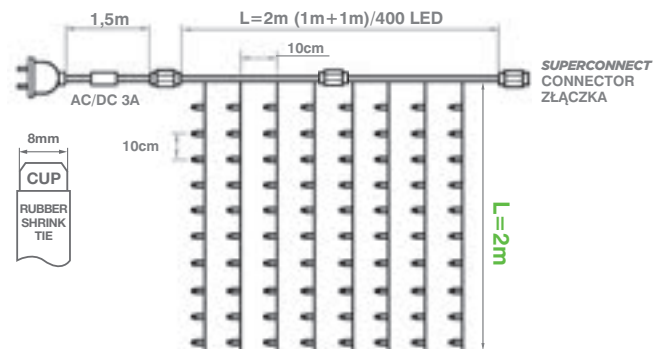

LED CURTAINS 2,5X3m PRO
KURTYNY LED 2,5x3m PRO



Power / Moc	92 W
Voltage / Zasilanie	230 V
Quantity of LEDs / Ilość diod w komplecie	600
Length x Height / Długość x Wysokość	2,5x3 m
Quantity of the strings / Ilość zwisów	20
Beam angle / Kąt świecenia	360°
Max connecting / Kompatybilność	up to 4 sets
Waterproof / Bryzgoszczelne	yes (IP65)
Type of cable / Rodzaj kabla	rubber 3mm
Type of plug / Rodzaj wtyczki	round EU

Index: POL-PLCL2,5X3,0-CW-W POL-PLCL2,5X3,0-WW-W POL-PLCL2,5X3,0-BLU-W
POL-PLCL2,5X3,0-CW-BL POL-PLCL2,5X3,0-WW-BL POL-PLCL2,5X3,0-BLU-BL

available LED colours
dostępne kolory LED



available cable colours
dostępne kolory przewodu

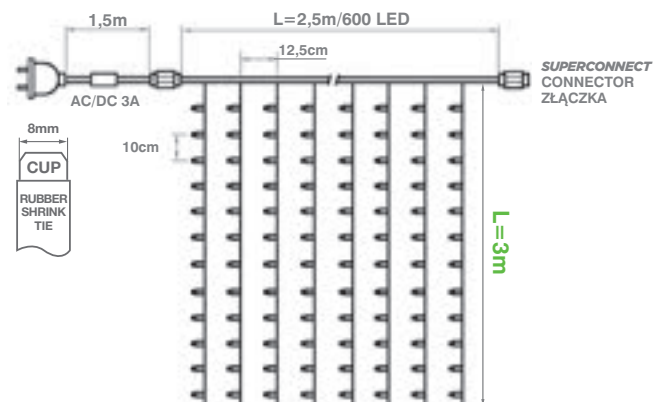

LED CURTAINS 2,5X6m PRO KURTYNY LED 2,5x6m PRO



Power / Moc	92 W
Voltage / Zasilanie	230 V
Quantity of LEDs / Ilość diod w komplecie	720
Length x Height / Długość x Wysokość	2,5x6 m
Quantity of the strings / Ilość zwisów	20
Beam angle / Kąt świecenia	360°
Max connecting / Kompatybilność	up to 2 sets
Waterproof / Bryzgoszczelne	yes (IP65)
Type of cable / Rodzaj kabla	rubber 3mm
Type of plug / Rodzaj wtyczki	round EU

Index: POL-PLCL2,5X6,0-CW-W POL-PLCL2,5X6,0-WW-W POL-PLCL2,5X6,0-BLU-W
POL-PLCL2,5X6,0-CW-BL POL-PLCL2,5X6,0-WW-BL POL-PLCL2,5X6,0-BLU-BL



available LED colours
dostępne kolory LED



available cable colours
dostępne kolory przewodu



GOLD SERIES

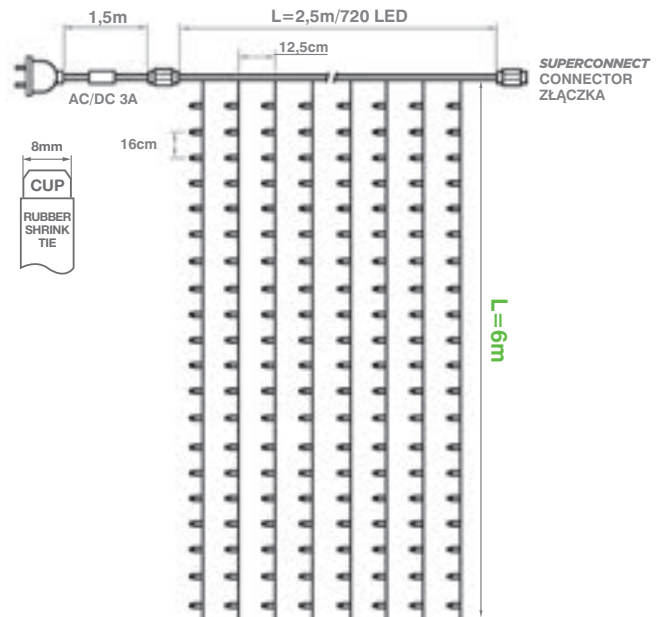

LED CURTAINS 2,5X9m PRO KURTYNY LED 2,5x9m PRO



Power / Moc	92 W
Voltage / Zasilanie	230 V
Quantity of LEDs / Ilość diod w komplecie	1000
Length x Height / Długość x Wysokość	2,5x9 m
Quantity of the strings / Ilość zwisów	20
Beam angle / Kąt świecenia	360°
Max connecting / Kompatybilność	up to 1 sets
Waterproof / Bryzgoszczelne	yes (IP65)
Type of cable / Rodzaj kabla	rubber 3mm
Type of plug / Rodzaj wtyczki	round EU

Index: POL-PLCL2,5X9,0-CW-W POL-PLCL2,5X9,0-WW-W POL-PLCL2,5X9,0-BLU-W
POL-PLCL2,5X9,0-CW-BL POL-PLCL2,5X9,0-WW-BL POL-PLCL2,5X9,0-BLU-BL



available LED colours
dostępne kolory LED



available cable colours
dostępne kolory przewodu



GOLD SERIES

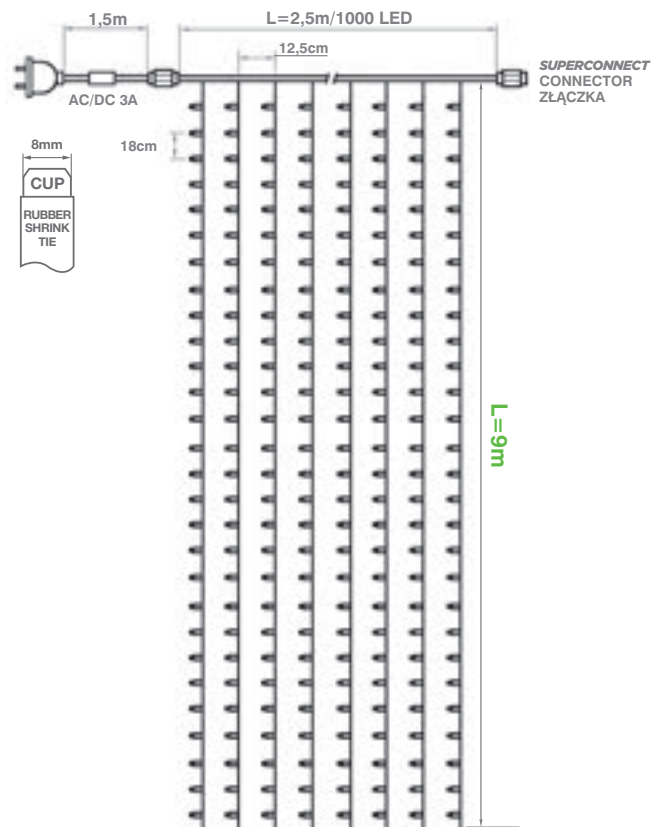



The curtains from the gold series are characterized by high resistance to adverse effects atmospheric conditions, such like rain, snow or frost. Thanks diodes, wires and especially that fittings rarely fail.

Kurtyny z serii złotej charakteryzują się wysoką odpornością na niekorzystne warunki atmosferyczne, takie jak deszcz, śnieg czy mróz. Dzięki temu diody, przewody a szczególnie łączki rzadko ulegają awariom.



LED CURTAINS 5X0,5m PRO FLASH KURTYNY LED 5x0,5m PRO FLASH



Power / Moc	18,4 W
Voltage / Zasilanie	230 V
Quantity of LEDs / Ilość diod w komplecie	240
Length x Height / Długość x Wysokość	5x0,5 m
Quantity of the strings / Ilość zwisów	48
Beam angle / Kąt świecenia	360°
Max connecting / Kompatybilność	up to 5 sets
Waterproof / Bryzgoszczelne	yes (IP65)
Type of cable / Rodzaj kabla	rubber 3mm
Type of plug / Rodzaj wtyczki	round EU

Index: POL-PLCLF5X0,5-CW-W POL-PLCLF5X0,5-WW-W
POL-PLCLF5X0,5-CW-BL POL-PLCLF5X0,5-WW-BL

192 LEDs + 48 LEDs FLASH cold white
192 LED + 48 LED FLASH białych zimnych



available LED colours
dostępne kolory LED



available cable colours
dostępne kolory przewodu

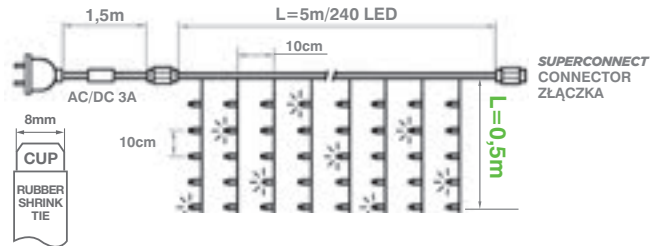

LED CURTAINS 5X1m PRO FLASH KURTYNY LED 5x1m PRO FLASH



Power / Moc	36,8 W
Voltage / Zasilanie	230 V
Quantity of LEDs / Ilość diod w komplecie	400
Length x Height / Długość x Wysokość	5x1 m
Quantity of the strings / Ilość zwisów	40
Beam angle / Kąt świecenia	360°
Max connecting / Kompatybilność	up to 4 sets
Waterproof / Bryzgoszczelne	yes (IP65)
Type of cable / Rodzaj kabla	rubber 3mm
Type of plug / Rodzaj wtyczki	round EU

Index: POL-PLCLF5X1,0-CW-W POL-PLCLF5X1,0-WW-W
POL-PLCLF5X1,0-CW-BL POL-PLCLF5X1,0-WW-BL

320 LEDs + 80 LEDs FLASH cold white
320 LED + 80 LED FLASH białych zimnych



available LED colours
dostępne kolory LED



available cable colours
dostępne kolory przewodu

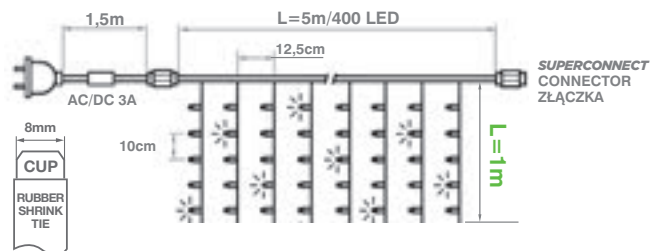

LED CURTAINS 2,5X1,5m PRO FLASH KURTYNY LED 2,5x1,5m PRO FLASH



Power / Moc	92 W
Voltage / Zasilanie	230 V
Quantity of LEDs / Ilość diod w komplecie	380
Length x Height / Długość x Wysokość	2,5x1,5 m
Quantity of the strings / Ilość zwisów	20
Beam angle / Kąt świecenia	360°
Max connecting / Kompatybilność	up to 4 sets
Waterproof / Bryzgoszczelne	yes (IP65)
Type of cable / Rodzaj kabla	rubber 3mm
Type of plug / Rodzaj wtyczki	round EU

Index: POL-PLCLF2,5X1,5-CW-W POL-PLCLF2,5X1,5-WW-W
POL-PLCLF2,5X1,5-CW-BL POL-PLCLF2,5X1,5-WW-BL

304 LEDs + 76 LEDs FLASH cold white
304 LED + 76 LED FLASH białych zimnych



available LED colours
dostępne kolory LED



available cable colours
dostępne kolory przewodu

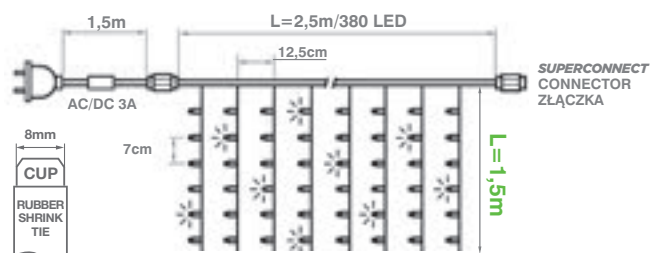

LED CURTAINS 2X2m PRO FLASH
KURTYNY LED 2x2m PRO FLASH



Power / Moc	92 W
Voltage / Zasilanie	230 V
Quantity of LEDs / Ilość diod w komplecie	400
Length x Height / Długość x Wysokość	2x2 m
Quantity of the strings / Ilość zwisów	20
Beam angle / Kąt świecenia	360°
Max connecting / Kompatybilność	up to 6 sets
Waterproof / Bryzgoszczelne	yes (IP65)
Type of cable / Rodzaj kabla	PVC 3mm
Type of plug / Rodzaj wtyczki	round EU

Index: POL-PLCLf2x2-CW-G POL-PLCLf2x2-WW-G

available LED colours
dostępne kolory LED



available cable colours
dostępne kolory przewodu



320 LEDs + 80 LEDs FLASH cold white
 320 LED + 80 LED FLASH białych zimnych

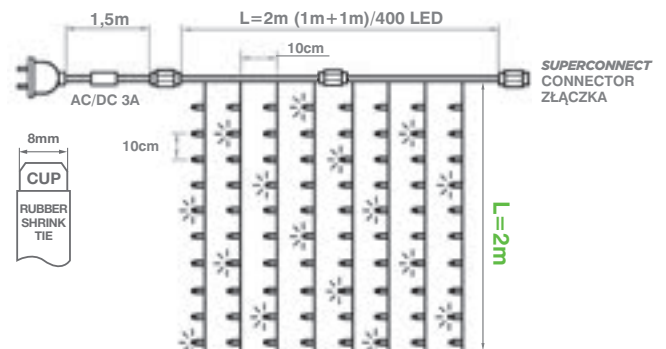

LED CURTAINS 2,5X3m PRO FLASH
KURTYNY LED 2,5x3m PRO FLASH



Power / Moc	92 W
Voltage / Zasilanie	230 V
Quantity of LEDs / Ilość diod w komplecie	600
Length x Height / Długość x Wysokość	2,5x3 m
Quantity of the strings / Ilość zwisów	20
Beam angle / Kąt świecenia	360°
Max connecting / Kompatybilność	up to 4 sets
Waterproof / Bryzgoszczelne	yes (IP65)
Type of cable / Rodzaj kabla	rubber 3mm
Type of plug / Rodzaj wtyczki	round EU

Index: POL-PLCLf2,5X3,0-CW-W POL-PLCLf2,5X3,0-WW-W
 POL-PLCLf2,5X3,0-CW-BL POL-PLCLf2,5X3,0-WW-BL

available LED colours
dostępne kolory LED



available cable colours
dostępne kolory przewodu



520 LEDs + 80 LEDs FLASH cold white
 520 LED + 80 LED FLASH białych zimnych

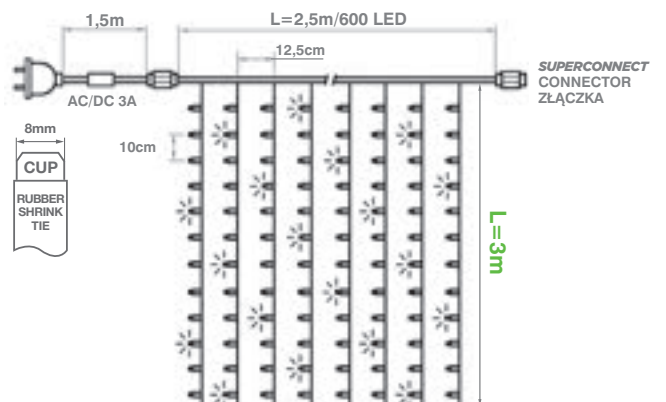

LED CURTAINS 2,5X6m PRO FLASH KURTYNY LED 2,5x6m PRO FLASH



Power / Moc	92 W
Voltage / Zasilanie	230 V
Quantity of LEDs / Ilość diod w komplecie	720
Length x Height / Długość x Wysokość	2,5x6 m
Quantity of the strings / Ilość zwisów	20
Beam angle / Kąt świecenia	360°
Max connecting / Kompatybilność	up to 2 sets
Waterproof / Bryzgoszczelne	yes (IP65)
Type of cable / Rodzaj kabla	rubber 3mm
Type of plug / Rodzaj wtyczki	round EU

Index: POL-PLCLF2,5X6,0-CW-W POL-PLCLF2,5X6,0-WW-W
POL-PLCLF2,5X6,0-CW-BL POL-PLCLF2,5X6,0-WW-BL



available LED colours
dostępne kolory LED



available cable colours
dostępne kolory przewodu



576 LEDs + 144 LEDs FLASH cold white
576 LED + 144 LED FLASH białych zimnych

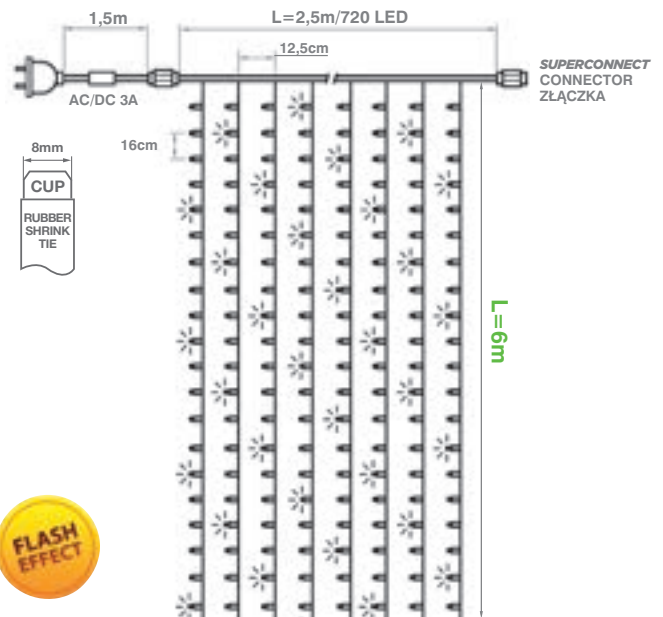

LED CURTAINS 2,5X9m PRO FLASH KURTYNY LED 2,5x9m PRO FLASH



Power / Moc	92 W
Voltage / Zasilanie	230 V
Quantity of LEDs / Ilość diod w komplecie	1000
Length x Height / Długość x Wysokość	2,5x9 m
Quantity of the strings / Ilość zwisów	20
Beam angle / Kąt świecenia	360°
Max connecting / Kompatybilność	up to 1 sets
Waterproof / Bryzgoszczelne	yes (IP65)
Type of cable / Rodzaj kabla	rubber 3mm
Type of plug / Rodzaj wtyczki	round EU

Index: POL-PLCLF2,5X9,0-CW-W POL-PLCLF2,5X9,0-WW-W
POL-PLCLF2,5X9,0-CW-BL POL-PLCLF2,5X9,0-WW-BL



available LED colours
dostępne kolory LED



available cable colours
dostępne kolory przewodu



800 LEDs + 200 LEDs FLASH cold white
800 LED + 200 LED FLASH białych zimnych

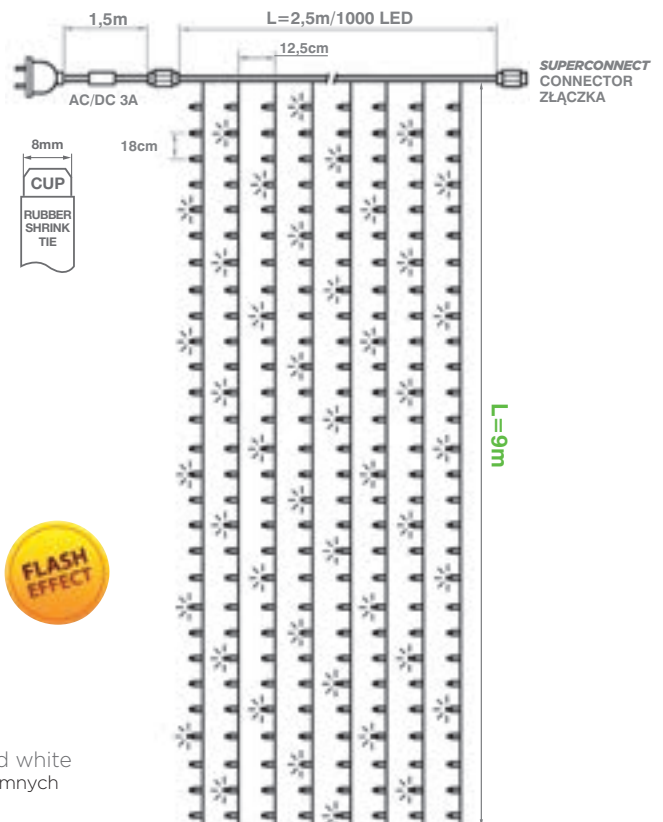



The curtains from the gold series are characterized by The Waterfall curtains have a spectacular waterfall effect, i.e. falling water. Thanks to this, they are perfect to decorate urban fountains. They can be used to decorate facades, Christmas trees, trees and to any space arrangement. They come in the following colors: cold white, blue. High resistance to adverse atmospheric conditions, such like rain, snow or frost. Thanks diodes, wires and especially that fittings rarely fail.

Kurтины Waterfall posiadają widowiskowy efekt wodospadu czyli spadającej wody. Dzięki temu idealnie nadają się do zdobienia miejskich fontann. Mogą mieć zastosowanie do zdobienia elewacji, choinek, drzew oraz do dowolnej aranżacji przestrzeni. Występują w następujących kolorach: biały zimny, niebieski.

WATERFALL LED CURTAINS 2,5X3m KURTyny LED Z EFEKTEM WODOSPADU 2,5x3m



Power / Moc	96 W
Voltage / Zasilanie	230 V
Quantity of LEDs / Ilość diod w komplecie	720
Length x Height / Długość x Wysokość	2,5x3 m
Quantity of the strings / Ilość zwisów	20
Beam angle / Kąt świecenia	360°
Max connecting / Kompatybilność	up to 3 sets
Waterproof / Bryzgoszczelne	yes (IP44)
Type of cable / Rodzaj kabla	PVC 2mm
Type of plug / Rodzaj wtyczki	round EU

Index: POL-LCLwf2,5X3,0-CW-W POL-LCLwf2,5X3,0-BLU-W

available LED colours
dostępne kolory LED



available cable colours
dostępne kolory przewodu



SILVER
SERIES

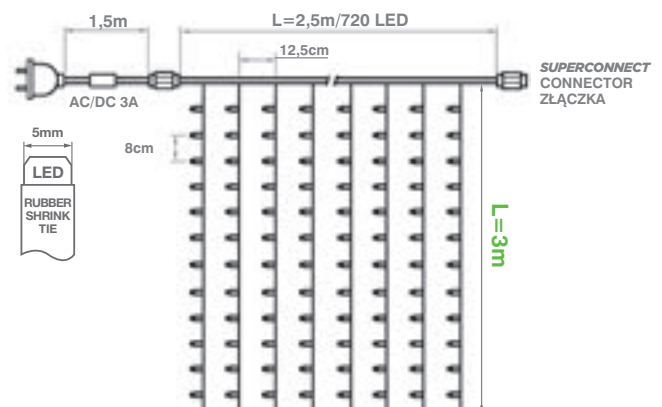

WATERFALL LED CURTAINS 2,5X6m KURTYNY LED Z EFEKTEM WODOSPADU 2,5x6m



Power / Moc	96 W
Voltage / Zasilanie	230 V
Quantity of LEDs / Ilość diod w komplecie	1440
Length x Height / Długość x Wysokość	2,5x6 m
Quantity of the strings / Ilość zwisów	20
Beam angle / Kąt świecenia	360°
Max connecting / Kompatybilność	up to 4 sets
Waterproof / Bryzgoszczelne	yes (IP44)
Type of cable / Rodzaj kabla	PVC 2mm
Type of plug / Rodzaj wtyczki	round EU

Index: POL-LCLwf2,5X6,0-CW-W POL-LCLwf2,5X6,0-BLU-W

available LED colours
dostępne kolory LED



available cable colours
dostępne kolory przewodu



SILVER
SERIES

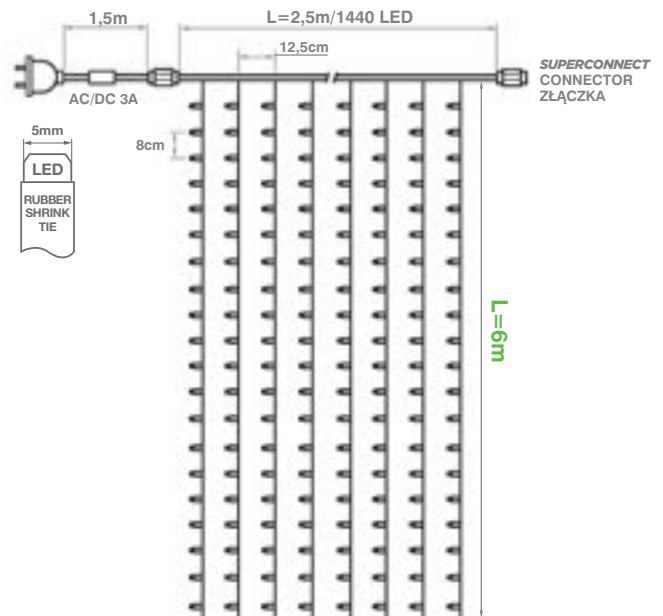

WATERFALL LED CURTAINS 2,5X3m PRO KURTYNY LED Z EFEKTEM WODOSPADU 2,5x3m PRO



Power / Moc	57,6 W
Voltage / Zasilanie	230 V
Quantity of LEDs / Ilość diod w komplecie	720
Length x Height / Długość x Wysokość	2,5x3 m
Quantity of the strings / Ilość zwisów	20
Beam angle / Kąt świecenia	360°
Max connecting / Kompatybilność	up to 3 sets
Waterproof / Bryzgoszczelne	yes (IP65)
Type of cable / Rodzaj kabla	rubber 3mm
Type of plug / Rodzaj wtyczki	round EU

Index: POL-PLCLwf2,5X3,0-CW-W POL-PLCLwf2,5X3,0-BLU-W

available LED colours
dostępne kolory LED



available cable colours
dostępne kolory przewodu



GOLD
SERIES

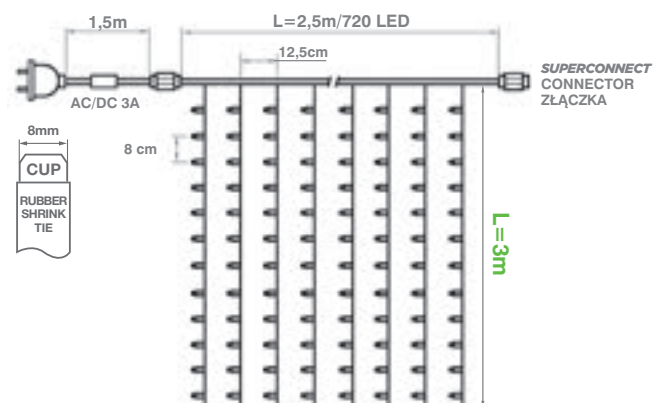



WATERFALL LED CURTAINS 2,5X6m PRO
KURTYNY LED Z EFEKTEM WODOSPADU 2,5x6m PRO



Power / Moc	96 W
Voltage / Zasilanie	230 V
Quantity of LEDs / Ilość diod w komplecie	1440
Length x Height / Długość x Wysokość	2,5x6 m
Quantity of the strings / Ilość zwisów	20
Beam angle / Kąt świecenia	360°
Max connecting / Kompatybilność	up to 3 sets
Waterproof / Bryzgoszczelne	yes (IP65)
Type of cable / Rodzaj kabla	rubber 3mm
Type of plug / Rodzaj wtyczki	round EU

Index: POL-PLCLwf2,5X6,0-CW-W POL-PLCLwf2,5X6,0-BLU-W

available LED colours
dostępne kolory LED



available cable colours
dostępne kolory przewodów



GOLD
SERIES



WATER
fall

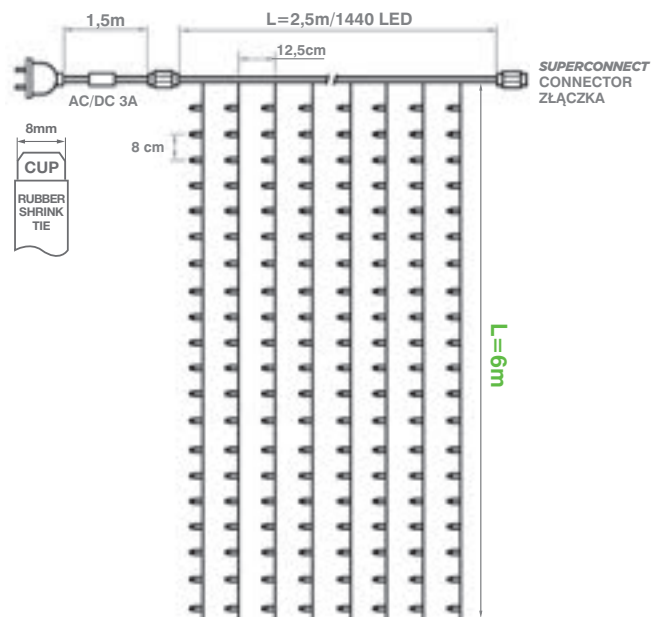

CHRISTMAS ILLUMINATIONS

LED NET LIGHTS

OŚWIETLENIE ŚWIĄTECZNE **SIATKI LED**

LED net, as the name suggests, is inspired by a shape of real net. Cables with lights are designed in such a way to form a diamond shaped apertures.

This product is assigned to gold series, which is the highest class of our stock, suitable only for outdoor use. There are 2 variants: standard and FLASH led lights. We can offer a net in the size of 2x1m with 176 LEDs. In the FLASH model you have 32 LEDs. Lifespan of our product is 100000 hours. Power supply is 18,4W and 230V.

High quality and endurance of POLAMP LED net guarantees long years of use. Light angle is 360 degrees. Due to a special socket, you can connect up to 5 sets of lights under one power supply.

We use christmas decoration at this special time of the year, which make us see it different from the standard decorations. We highly recommend you to take up on our offer.

Siatka LED, jak sama nazwa wskazuje, jest inspirowana kształtem standardowej siatki. Sznury z diodami są przeplecione w taki sposób, aby tworzyły otwory w kształcie rombów.

Produkt przypisaliśmy do złotej serii, czyli do najwyższej klasy asortymentu POLAMP, przeznaczonego do użytku wyłącznie zewnętrznego. W dwóch wariantach, pierwszy - z diodami stałymi, drugi - z diodami FLASH, oferujemy siatkę w rozmiarze 2x1m i z 176 diodami. W siatkach z efektem błysku mamy 32 diody LED. Wszystkie źródła światła mogą świecić ok. 100000 godzin. Potrzebna moc - 18,4W. Zasilanie 230V.

Jakość siatki POLAMP i odporność na uszkodzenia, czy promieniowanie UV, jest bardzo wysoka. Kąt świecenia to 360°. Na jednym kablu zasilającym, z pomocą opatentowanej złączki, może efektywnie działać do 5 kompletów. Oświetlenie w okresie Świąt tak różne, niż to codzienne użytkowe, buduje atmosferę, jak żadna inna dekoracja. Zapraszamy do skorzystania z naszej oferty!



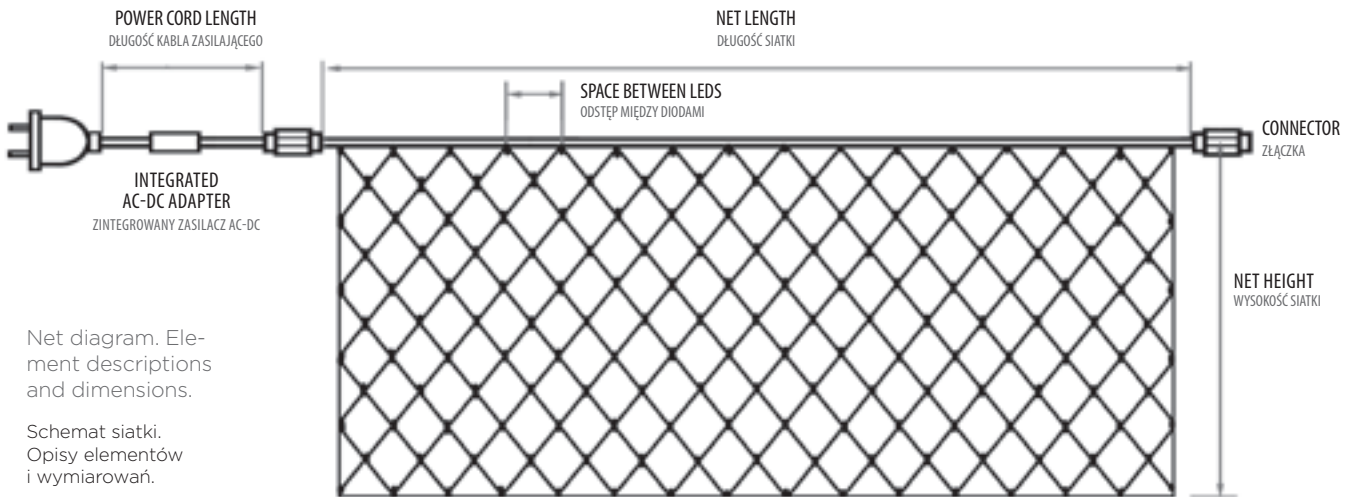

Net diagram. Element descriptions and dimensions.

Schemat siatki. Opisy elementów i wymiarowań.



The nets are characterized by high resistance to adverse conditions atmospheric conditions such as rain, snow or frost. Thanks to that diodes, wires and especially connectors rarely fail.

Siatki charakteryzują się wysoką odpornością na niekorzystne warunki atmosferyczne, takie jak deszcz, śnieg czy mróz. Dzięki temu diody, przewody a szczególnie złączki rzadko ulegają awariom.



LED NET LIGHTS 2X1m PRO SIATKI LED 2x1m PRO



Power / Moc	18,4 W
Voltage / Zasilanie	230 V
Quantity of LEDs / Ilość diod w komplecie	176
Length x Height / Długość x Wysokość	2x1 m
Beam angle / Kąt świecenia	360°
Max connecting / Kompatybilność	up to 5 sets
Waterproof / Bryzgoszczelne	yes (IP65)
Type of cable / Rodzaj kabla	rubber 3mm
Type of plug / Rodzaj wtyczki	round EU

Index: POL-LNL1X2-CW-BL POL-LNL1X2-WW-BL

available LED colours
dostępne kolory LED



available cable colours
dostępne kolory przewodu



GOLD SERIES

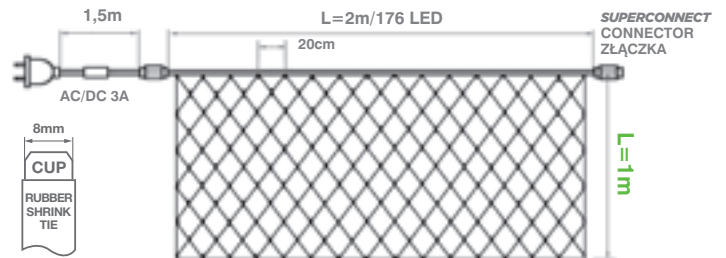

LED NET LIGHTS 2X1m PRO FLASH SIATKI LED 2x1m PRO FLASH



Power / Moc	18,4 W
Voltage / Zasilanie	230 V
Quantity of LEDs / Ilość diod w komplecie	176
Length x Height / Długość x Wysokość	2x1 m
Beam angle / Kąt świecenia	360°
Max connecting / Kompatybilność	up to 5 sets
Waterproof / Bryzgoszczelne	yes (IP65)
Type of cable / Rodzaj kabla	rubber 3mm
Type of plug / Rodzaj wtyczki	round EU

Index: POL-LNL1X2-CW-BL POL-LNL1X2-WW-BL

available LED colours
dostępne kolory LED



available cable colours
dostępne kolory przewodu



144 LEDs + 32 LEDs FLASH cold white
144 LED + 32 LED FLASH białych zimnych



GOLD SERIES

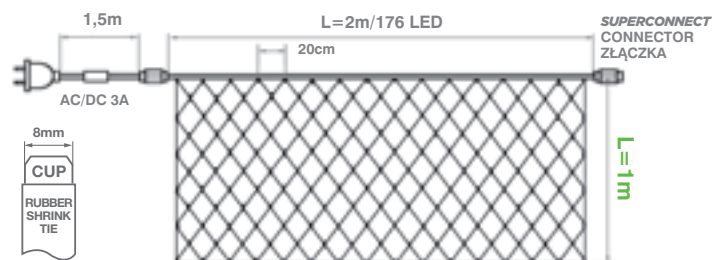

EU round plug.
Wtyczka okrągła typu EU.

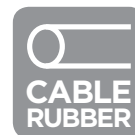

The SUPERCONNECT connector is weather resistant and easy to use.
Złączka SUPERCONNECT jest odporna na warunki atmosferyczne i łatwa w użyciu.





Nets work well wherever there is limited the possibility of mounting lighting e.g. over the streets.

Siatki sprawdzają się wszędzie tam gdzie istnieje ograniczona możliwość umocowania oświetlenia np. nad ulicami.

CHRISTMAS ILLUMINATIONS

LED METEORS AND STALACTITES LIGHTS

OŚWIETLENIE ŚWIĄTECZNE **METEORKI I STALAKTYTY LED**

Meteors are a product related to standard and small LED curtains. Dedicated for outdoor illumination.

Similar to curtains, meteors have equal length overhangs (tubes) with LEDs. They illuminate as white meteors falling from the sky. Connection cable is 5m in length.

Cable lengths are: 20cm with 240 LEDs, 25cm with 160 LEDs, 50cm with 320 LEDs and 100 cm with 640 LEDs. As a product suitable for ell, roof and window decoration, meteors are durable, UV and splash proof. They have a very high brightness and long life (100000 hours). Voltage is 230V, 24V and power supply 24 W.

You can connect up to 10 or 3 sets of lights by a special socket.

There is an option of arranging meteors into a star. Light makes a pulse effect and glamorous illumination.

Meteorki to produkt pokrewny kurtynom i kurtynkom LED. Są przeznaczone do tworzenia iluminacji w przestrzeni zewnętrznej.

Podobnie, jak kurtyny mają zwisy (tuby) z diodami równej długości. Świecą one jak spadające meteorki w kolorze bieli. Przewód przyłączeniowy mierzy 5 metrów.

Długości sznurów z LED to 20 cm z 240 diodami, 25 cm z 160 diodami, 50 cm z 320 źródłami światła lub 100 cm z 640. Jako produkt do zdobienia elewacji, okien, czy dachów, są bryzgoszczelne. Mają bardzo wysoką jakość, a zatem i żywotność (100000 godzin świecenia), ponadto bardzo wysoka odporność na uszkodzenia i promieniowanie UV. Zasilanie 230V lub 24V a moc 24W.

Zestaw meteorków LED zachowujący kompatybilność powinien liczyć maksymalnie 10 lub 3 komplety. Łączy się je opatentowaną złączką.

Ciekawym rozwiązaniem, dostępnym w naszej ofercie, jest ułożenie meteorków w gwiazdę. Przepływające światło daje efekt pulsowania i jest efektną dekoracją świetlną.



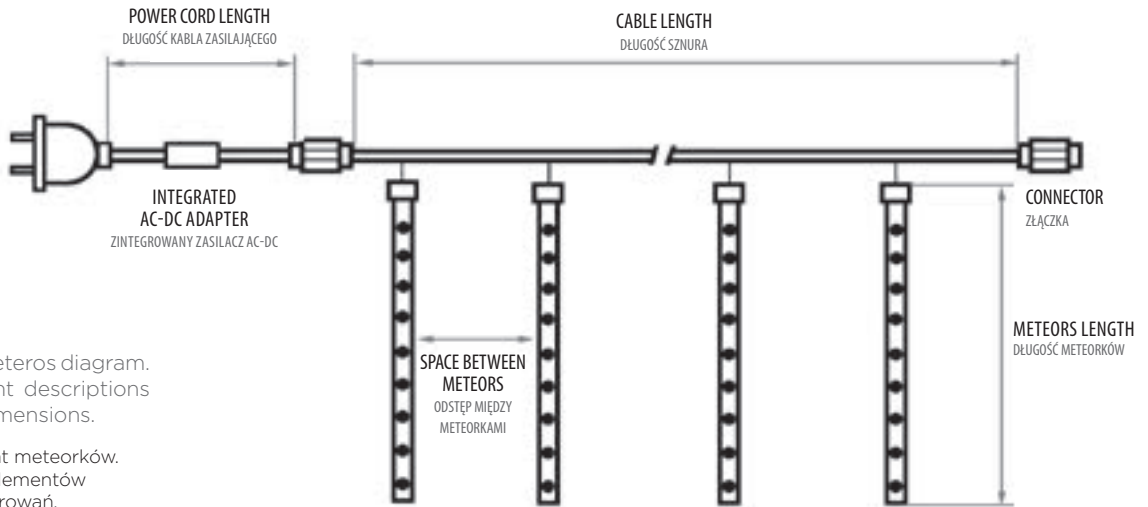

Led meters diagram.
Element descriptions
and dimensions.

Schemat meteorków.
Opisy elementów
i wymiarowań.

The SUPERCONNECT connector is weather resistant and easy to use.
Złączka SUPERCONNECT jest odporna na warunki atmosferyczne i łatwa w użyciu.



LED METEORS LIGHTS 20cm PRO METEORKI LED 20 cm PRO



Power / Moc	2,4 W
Voltage / Zasilanie	230 V
Quantity of LEDs / Ilość diod w komplecie	240
Length x Height / Długość x Wysokość	6x0,20 m
Quantity of the meteors / Ilość meteorków	12
Beam angle / Kąt świecenia	360°
Max connecting / Kompatybilność	up to 10 sets
Waterproof / Bryzgoszczelne	yes (IP65)
Type of cable / Rodzaj kabla	rubber 3mm
Type of plug / Rodzaj wtyczki	round EU

Index: POL-MET20-CW-G

available LED colours
dostępne kolory LED



available cable colours
dostępne kolory przewodu



GOLD SERIES

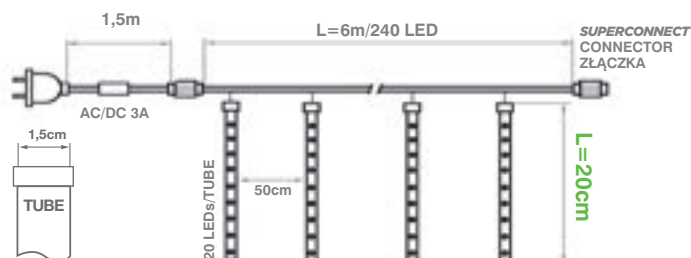

LED METEORS LIGHTS 25cm PRO METEORKI LED 25 cm PRO



Power / Moc	24 W
Voltage / Zasilanie	24 V
Quantity of LEDs / Ilość diod w komplecie	160
Length x Height / Długość x Wysokość	5x0,25 m
Quantity of the meteors / Ilość meteorków	5
Beam angle / Kąt świecenia	360°
Max connecting / Kompatybilność	up to 3 sets
Waterproof / Bryzgoszczelne	yes (IP65)
Type of cable / Rodzaj kabla	rubber 3mm
Type of plug / Rodzaj wtyczki	round EU

Index: POL-MET25-CW-G

available LED colours
dostępne kolory LED



available cable colours
dostępne kolory przewodu



GOLD SERIES

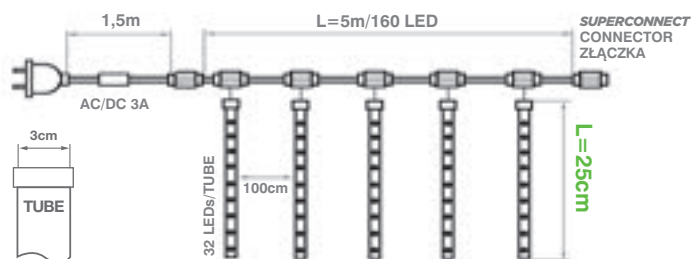

LED METEORS LIGHTS 50cm PRO METEORKI LED 50 cm PRO



Power / Moc	24 W
Voltage / Zasilanie	24 V
Quantity of LEDs / Ilość diod w komplecie	320
Length x Height / Długość x Wysokość	5x0,5 m
Quantity of the meteors / Ilość meteorków	5
Beam angle / Kąt świecenia	360°
Max connecting / Kompatybilność	up to 3 sets
Waterproof / Bryzgoszczelne	yes (IP65)
Type of cable / Rodzaj kabla	rubber 3mm
Type of plug / Rodzaj wtyczki	round EU

Index: POL-MET50-CW-G POL-MET50-WW-G

available LED colours
dostępne kolory LED



available cable colours
dostępne kolory przewodu



GOLD SERIES

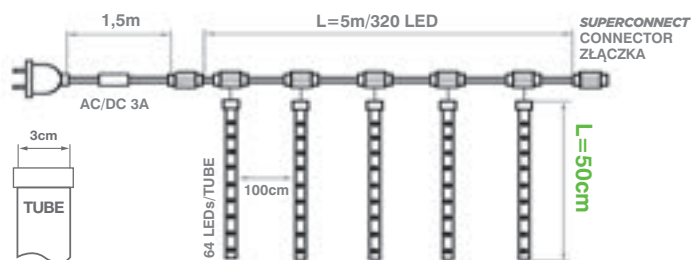

LED METEORS LIGHTS 100cm PRO METEORKI LED 100 cm PRO



Power / Moc	9,6 W
Voltage / Zasilanie	230 V
Quantity of LEDs / Ilość diod w komplecie	640
Length x Height / Długość x Wysokość	5x1 m
Quantity of the meteors / Ilość meteorków	5
Beam angle / Kąt świecenia	360°
Max connecting / Kompatybilność	up to 3 sets
Waterproof / Bryzgoszczelne	yes (IP65)
Type of cable / Rodzaj kabla	rubber 3mm
Type of plug / Rodzaj wtyczki	round EU

Index: POL-MET100-CW-G

available LED colours
dostępne kolory LED



available cable colours
dostępne kolory przewodu



GOLD SERIES

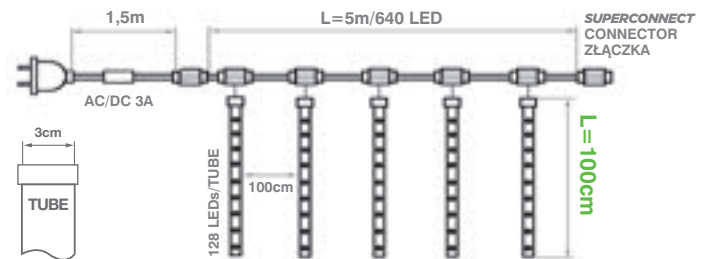

LED STALACTITES STALAKTYTY LED



Power / Moc	0,5 W
Voltage / Zasilanie	24 V
Quantity of LEDs / Ilość diod w komplecie	24
Length x Height / Długość x Wysokość	10m x 15cm
Quantity of the stalactites / Ilość stalaktytów	24
Beam angle / Kąt świecenia	360°
Waterproof / Bryzgoszczelne	yes (IP44)
Type of cable / Rodzaj kabla	PVC 2mm
Type of plug / Rodzaj wtyczki	round EU

Index: POL-LSTL10M-CW-BL

available LED colours
dostępne kolory LED



available cable colours
dostępne kolory przewodu



SILVER SERIES

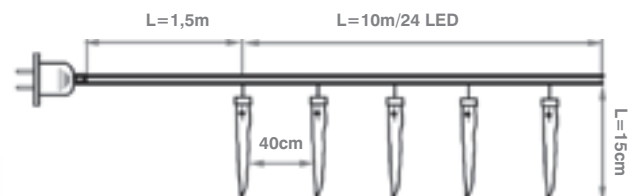

CHRISTMAS ILLUMINATIONS LED AND BULB ROPE LIGHTS

OŚWIETLENIE ŚWIĄTECZNE **WĘŻE ŚWIETLNE LED I ŻARÓWKOWE**

We produce LED and bulb rope lights in a wide variety of colours. Our stock is one of the biggest in Europe. We offer several dozens of rope lights which are compatible with products made by other companies due to universal connections.

Outdoor bulb rope lights have 36 bulbs each meter. You can easily cut ropes in certain places which are located also each meter. There are LED colours available, you can also order a custom colour. Similar number of lights have LED one channel rope lights in gold series. All ropes have 13mm in diameter and are powered directly from a standard socket by a special cable which is also available in our offer. One roll contains 100 meters of rope light. You can cut the rope each 1 or 2 meters. These models are available in different colour variants. All rope lights have LEDs set in a horizontal position. Our products have high quality and flexibility, which makes them perfect for tree decorations, especially when the tree grows through the year. As our other products, life span is 100000 hours.

Our other products are for example FLASH rope light, which has automatic function of strobe light in each 6 LEDs. 3-channel rope lights shine with constant or variable light and can be cut each 4 meters. NEON rope light, one of the newest products in our offer. It has very high density of LEDs - up to 80 in one meter. The gauge of neon rope light is 12x26mm. It can be cut each 80-120cm.

Węże świetlne LED i żarówkowe produkujemy w bogatej gamie kolorystycznej a stan magazynowy mamy jeden z największych w Europie. Samych rodzajów węży oferujemy kilkadziesiąt. Są kompatybilne z produktami innych firm, dzięki zastosowaniu uniwersalnych połączeń.

Węże żarówkowe zewnętrzne mają po 36 żarówek na mb. Można je ciąć co 1 metr. Dostępne są kolory LED jednolite z oferty katalogowej lub na zamówienie. Podobną ilość źródeł światła mają węże diodowe jednocanałowe w serii złotej marki POLAMP, świecące światłem stałym. Średnica produktu to 13 mm. Zasilane są bezpośrednio z sieci dzięki specjalnemu kablowi dostępnemu w naszej ofercie. Długość rolki to 100 m. Możliwość cięcia co 1 lub 2 metry. Te modele dostępne są w wielu wariantach kolorystycznych. Wszystkie dostępne są w wariantach diod ułożonych horizontalnie. Mają bardzo wysoką jakość i są elastyczne, dzięki czemu można dekorować nimi np. drzewa, nie tracąc efektu w przyszłym sezonie, gdy rośliny urosną. Ich żywotność obliczamy na 100000 godzin świecenia.

Inne produkty to np. wąż FLASH ma automatyczną funkcję błysku świetlnego, w co 6. diodzie. Węże świetlne trzykanałowe świecą światłem stałym lub zmiennym. Istnieje możliwość cięcia co 4 m. Wąż NEON, jeden z najnowszych produktów w ofercie, charakteryzuje się dużą gęstością diod - aż 80 w 1 mb. Ma przekrój 12 x 26 mm. Możliwość cięcia co 80-120 cm.

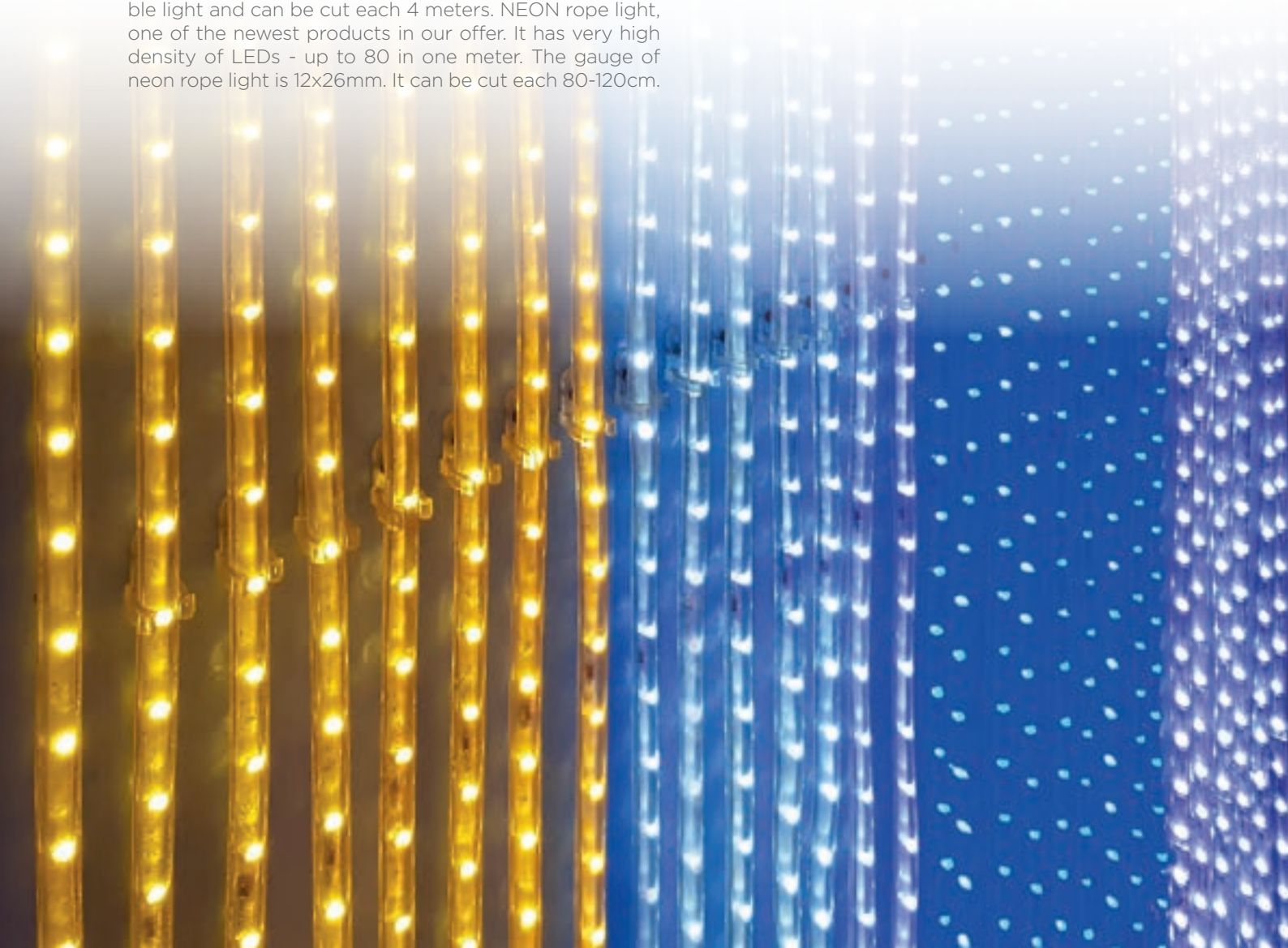



Rope light gives endless opportunities of creating christmas decorations such as 3D stars which can be placed on top of a christmas tree or snowflakes used as a decoration. Unique example of a decoration can be a LED rope light reindeer sized 70x78x16cm which has 160 very efficient LEDs.

You can also find a wide range of accessories in our offer, which can make your installation or controlling your rope light much easier. Furthermore, we can prepare special sets of rope lights which you can install by yourself, as well as cutting rope lights into different lengths.

Z węży LED tworzy się ozdoby świąteczne, np. duże przestrzenne figury 3D lub gwiazdy i śnieżynki wiszące jako świetlna dekoracja. Wyjątkową ozdobą jest renifer z węża LED o wymiarach 70x78x16 cm wykorzystujący w konstrukcji 160 wydajnych diod LED.

W ofercie znajdziesz także bogaty wybór akcesoriów, ułatwiający instalację węży, sterowanie i łączenie z innymi typami oświetlenia POLAMP. Ponadto proponujemy cięcie na dowolną długość oraz sprzedaż gotowych zestawów, przeznaczonych do montażu.



Examples of rope accessories.
Przykładowe akcesoria do węży.

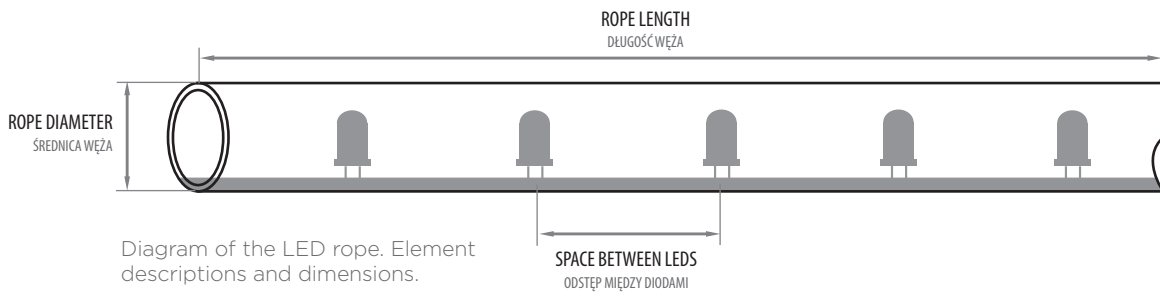

Schemat węża LED.
Opisy elementów i wymiarowań.

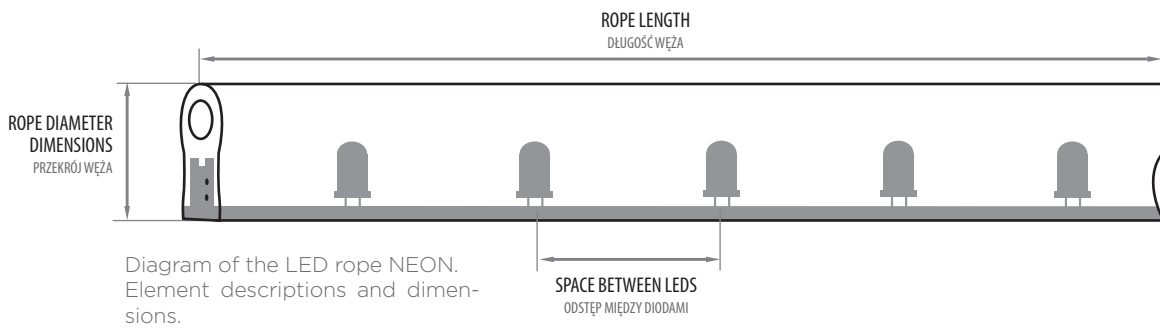

Schemat węża NEON LED.
Opisy elementów i wymiarowań.

VERTICAL LED PLACING
UŁOŻENIE DIOD WERTYKALNE

narrow beam angle
wąski kąt świecenia



HORIZONTAL LED PLACING
UŁOŻENIE DIOD HORYZONTALNE

wide beam angle
szeroki kąt świecenia



LIGHT TRAVEL ALONG THE ROPE
ŚWIATŁO BIEGNIE WZDŁUŻ WĘŻA



Power Supply 24V for rope led.
Zasilacz 24v do węża LED.



**GOLD
SERIES**

**Ø
13mm**

**IP
65**

A

LED ROPE PRO NK1 CUT LENGTH 2m WAŻ ŚWIETLNY LED PRO NK1 cięty co 2m



Power / Moc	3,45 W/m
Voltage / Zasilanie	230 V
Quantity of LEDs / Ilość diod	36/m
Rope length / Długość węża	100 m
Beam angle / Kąt świecenia	180°
Waterproof / Bryzgoszczelne	yes (IP67)
LED placing / Ułożenie diod	vertical/wertykalne
Metered rope / Cięcie co	2m

Index:	POL-LRLNK1-CW2	POL-LRLNK1-P2	POL-LRLNK1-BLU2
	POL-LRLNK1-WW2	POL-LRLNK1-R2	POL-LRLNK1-G2
	POL-LRLNK1-Y2	POL-LRLNK1-PU2	POL-LRLNK1-M2
	POL-LRLNK1-O2	POL-LRLNK1-SBLU2	



GOLD SERIES



available LED colours
dostępne kolory LED

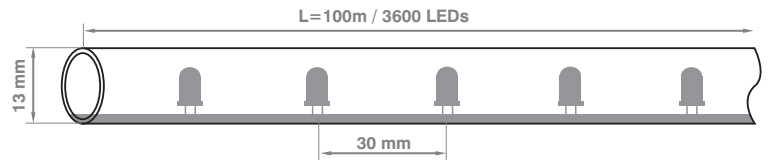

LED ROPE PRO NK1 CUT LENGTH 1m WAŻ ŚWIETLNY LED PRO NK1 cięty co 1m



Power / Moc	3,45 W/m
Voltage / Zasilanie	230 V
Quantity of LEDs / Ilość diod	36/m
Rope length / Długość węża	100 m
Beam angle / Kąt świecenia	180°
Waterproof / Bryzgoszczelne	yes (IP67)
LED placing / Ułożenie diod	vertical/wertykalne
Metered rope / Cięcie co	1m

Index:	POL-LRLNK1-CW1	POL-LRLNK1-Y1	POL-LRLNK1-SBLU1
	POL-LRLNK1-NW1	POL-LRLNK1-O1	POL-LRLNK1-BLU1
	POL-LRLNK1-WW1	POL-LRLNK1-R1	POL-LRLNK1-G1
	POL-LRLNK1-CLW1	POL-LRLNK1-PU1	POL-LRLNK1-M1



GOLD SERIES



available LED colours
dostępne kolory LED

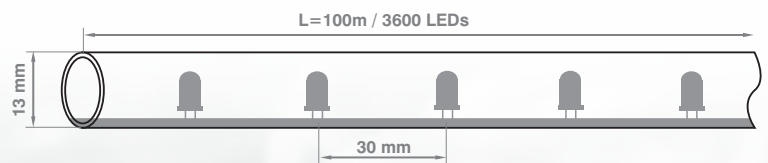
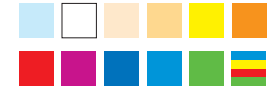

LED ROPE PRO NK1 H CUT LENGTH 1m
WAŻ ŚWIETLNY LED PRO NK1 H cięty co 1m



Power / Moc	3,45 W/m
Voltage / Zasilanie	230 V
Quantity of LEDs / Ilość diod	36/m
Rope length / Długość węża	100 m
Beam angle / Kąt świecenia	270°
Waterproof / Bryzgoszczelne	yes (IP67)
LED placing / Ułożenie diod	horizontal/horyz.
Metered rope / Cięcie co	1m

Index:	POL-LRLNK1H-CW1	POL-LRLNK1H-Y1	POL-LRLNK1H-BLU1
	POL-LRLNK1H-NW1	POL-LRLNK1H-O1	POL-LRLNK1H-PU1
	POL-LRLNK1H-WW1	POL-LRLNK1H-R1	POL-LRLNK1H-G1
	POL-LRLNK1H-CLW1	POL-LRLNK1H-SBLU1	POL-LRLNK1H-RGB1



available LED colours
dostępne kolory LED

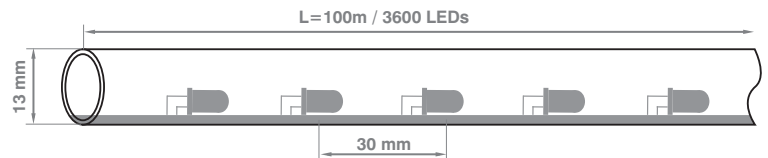

LED ROPE PRO NK1 H 24V CUT LENGTH 1m
WAŻ ŚWIETLNY LED PRO NK1 H 24V cięty co 1m



Power / Moc	2,5 W/m
Voltage / Zasilanie	24 V
Quantity of LEDs / Ilość diod	36/m
Rope length / Długość węża	100 m
Beam angle / Kąt świecenia	270°
Waterproof / Bryzgoszczelne	yes (IP67)
LED placing / Ułożenie diod	horizontal/horyz.
Metered rope / Cięcie co	1m

Index:	POL-LRL24VNK1H-Y1	POL-LRL24VNK1H-BLU1	POL-LRL24VNK1H-G1
	POL-LRL24VNK1H-R1	POL-LRL24VNK1H-CW1	POL-LRL24VNK1H-WW1



available LED colours
dostępne kolory LED

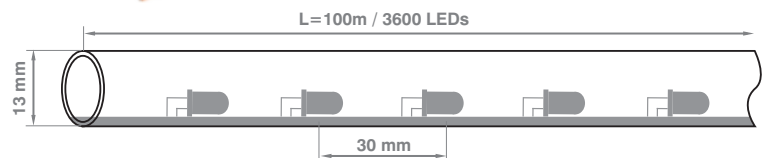

LED ROPE PRO NK3 CUT LENGTH 4m
WAŻ ŚWIETLNY LED PRO NK3 cięty co 4m



Power / Moc	1,7 W/m
Voltage / Zasilanie	230 V
Quantity of LEDs / Ilość diod	36/m
Rope length / Długość węża	100 m
Beam angle / Kąt świecenia	180°
Waterproof / Bryzgoszczelne	yes (IP67)
LED placing / Ułożenie diod	vertical/wertykalne
Metered rope / Cięcie co	4m

Index:	POL-LRLNK3-CW4	POL-LRLNK3-WW	POL-LRLNK3-BLU4
--------	----------------	---------------	-----------------



available LED colours
dostępne kolory LED

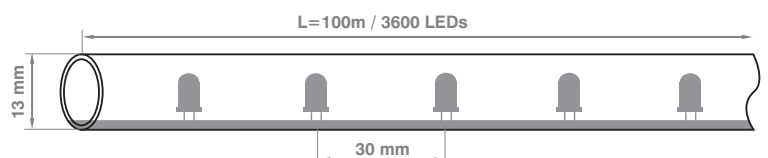

LED ROPE PRO NK1 CUT LENGTH 2m FLASH WAŻ ŚWIETLNY LED PRO NK1 cięty co 2m FLASH



Power / Moc	3,45 W/m
Voltage / Zasilanie	230 V
Quantity of LEDs / Ilość diod	36/m
Rope length / Długość węża	100 m
Beam angle / Kąt świecenia	180°
Waterproof / Bryzgoszczelne	yes (IP67)
LED placing / Ułożenie diod	vertical/wertykalne
Metered rope / Cięcie co	2m

Index: POL-LRLfNK1-CW2 POL-LRLfNK1-PU2
POL-LRLfNK1-WW2 POL-LRLfNK1-BLU2
POL-LRLfNK1-R2

30 LEDs + 6 LEDs FLASH
30 LED + 6 LED FLASH



GOLD SERIES

available LED colours
dostępne kolory LED

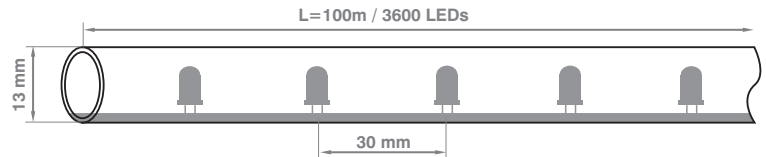

LED ROPE PRO NK1 H CUT LENGTH 1m FLASH WAŻ ŚWIETLNY LED PRO NK1 H cięty co 1m FLASH



Power / Moc	3,45 W/m
Voltage / Zasilanie	230 V
Quantity of LEDs / Ilość diod	36/m
Rope length / Długość węża	100 m
Beam angle / Kąt świecenia	270°
Waterproof / Bryzgoszczelne	yes (IP67)
LED placing / Ułożenie diod	horizontal/horyz.
Metered rope / Cięcie co	1m

Index: POL-LRLfNK1-CW1

30 LEDs + 6 LEDs FLASH
30 LED + 6 LED FLASH



GOLD SERIES

available LED colours
dostępne kolory LED

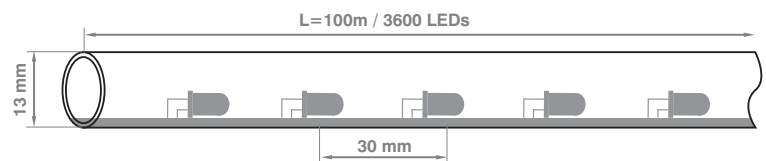

BULB ROPE PRO NK1 CUT LENGTH 1m WAŻ ŚWIETLNY ŻARÓWKOWY PRO NK1 cięty co 1m



Power / Moc	16,1 W/m
Voltage / Zasilanie	230 V
Quantity of BULBs / Ilość żarówek	36/m
Rope length / Długość węża	100 m
Beam angle / Kąt świecenia	180°
Waterproof / Bryzgoszczelne	yes (IP67)
BULB placing / Ułożenie żarówek	vertical/wertykalne
Metered rope / Cięcie co	1m

Index: POL-RRLNK1-W1 POL-RRLNK1-BLU1
POL-RRLNK1-Y1 POL-RRLNK1-G1
POL-RRLNK1-R1



GOLD SERIES

available LED colours
dostępne kolory LED

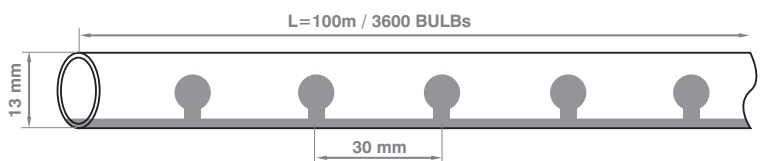

LED ROPE NK1 TEST SAMPLE 2m
 PROFESJONALNY WĄŻ LED NK1
 odcinek testowy 2 m



2m	230 V	36 LED/m	2,5W mb
∅ 13mm	V	IP 67	A

POL-LRLNK1-EXAMP



GOLD SERIES

Test sample of LED NK1 rope light which has all the colours available in a 2m section.

2-metrowy, testowy odcinek węża świetlnego LED NK1 zawierający wszystkie dostępne kolory.

available LED colours
 dostępne kolory LED



NEON LED ROPE PRO NK1 WAŻ ŚWIETLNY LED NEON PRO NK1

5,3 W/m 230 V 80 LEDs/m 50 m 270° 12x26 mm -X- 0,9m -X- 1,2m IP 67 A

Power / Moc	5,3 W/m (3,9W in red)
Voltage / Zasilanie	230 V
Quantity of LEDs / Ilość diod	80/m
Rope length / Długość węża	50 m
Beam angle / Kąt świecenia	180°
Waterproof / Bryzgoszczelne	yes (IP67)
Metered rope / Cięcie co	0,9/1,2m (red/yellow)

Index: POL-LNFss-CW POL-LNFss-Y POL-LNFss-BLU
POL-LNFss-WW POL-LNFss-R POL-LNFss-G



available LED colours
dostępne kolory LED

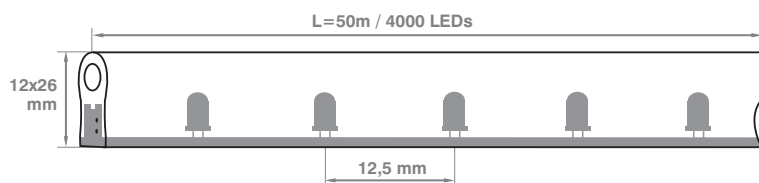

NEON LED ROPE PRO NK1 12V WAŻ ŚWIETLNY LED NEON PRO NK1 12V

8 W/m 12V 120 LEDs/m 50 m 270° 12x26 mm -X- 25mm IP 67 A

Power / Moc	8W/m
Voltage / Zasilanie	12 V
Quantity of LEDs / Ilość diod	120/m
Rope length / Długość węża	50 m
Beam angle / Kąt świecenia	180°
Waterproof / Bryzgoszczelne	yes (IP67)
Metered rope / Cięcie co	25mm

Index: POL-LNFss12V-CW POL-LNFss12V-P POL-LNFss12V-PU
POL-LNFss12V-WW POL-LNFss12V-R POL-LNFss12V-G
POL-LNFss12V-Y POL-LNFss12V-BLU



available LED colours
dostępne kolory LED

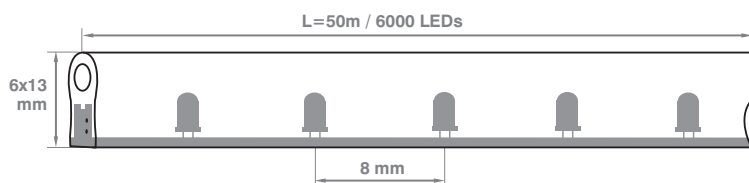

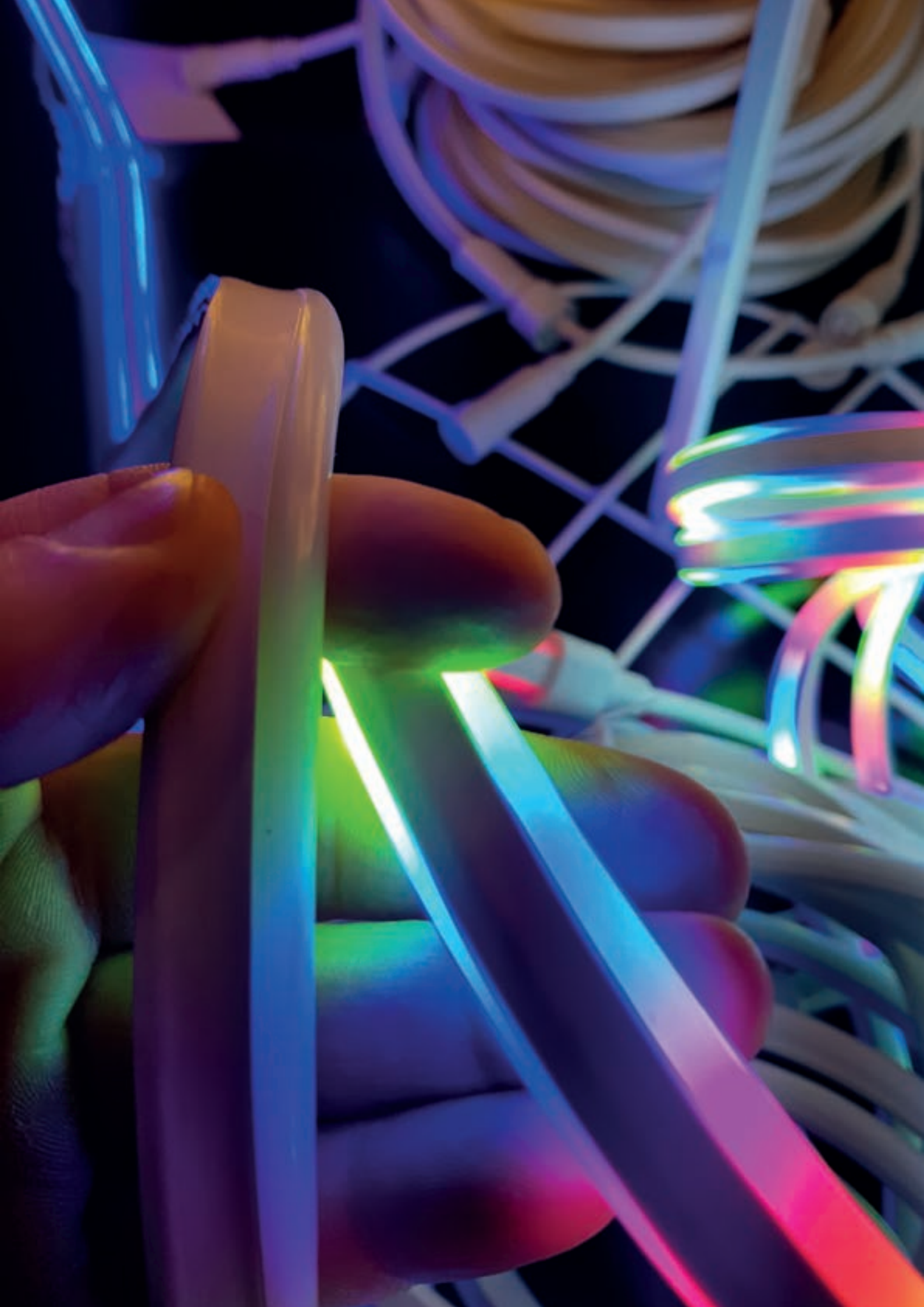

CHRISTMAS ILLUMINATIONS ACCESSORIES

OŚWIETLENIE ŚWIĄTECZNE AKCESORIA

All of the installations require at least few accessories in order to work properly and effectively without any problems to provide a proper illumination formula.

POLAMP LED rope lights, due to its durability, flexibility and long life are products that were meant to be used for many years. Each season you can use our rope lights to different kinds of decoration. In our offer, you can find many LED rope light connectors, power supply and extension cables, control units, clips, heat shrink tubes, glues, handles, and plugs. We also have similar choice of professional accessories for LED string lights, curtains and nets. We offer cables for curtains, multiplugs, extension cables, handles, tensioners and steel tapes.

Węże LED POLAMP ze względu na swą trwałość, żywotność świetlną i elastyczność, są produktami przeznaczonymi do użytku przez wiele lat. Z każdym sezonem można je wieszać na inny sposób. Wszystkie instalacje wymagają co najmniej kilku dodatków, aby mogły efektywnie i stabilnie działać, zgodnie z przewidywaną formułą iluminacji.

W ofercie naszej marki znajdziesz wszelkiego typu złączki do węży LED, kable zasilające i rozszerzające, programatory i sterowniki, kontrolery, zaślepki, przewody, uchwyty i klipy, koszulki termokurczliwe, kleje, kanały montażowe. Podobnie profesjonalny osprzęt montażowy mamy do lampek, kurtynek i siatek LED. Oferujemy kable do tworzenia kurtyn, rozgałęźniki, przewody rozszerzające i przedłużające, uchwyty, napinacze i taśmy stalowe.



LED rope connectors.
Przelotki do węży LED



NEON rope light plug.
Zaślepka do węży NEON



3 pin rope light connector.
3-pinowa złączka do węży



2 pin rope light connector.
2-pinowa złączka do węży



2 pin rope light connection
with power supply cable.

2-pinowa złączka do łączenia
węży z kablem zasilającym



U type plastic grip.
Uchwyt do węży

Rope light power supply cable with control unit.

Kabel zasilający ze sterownikiem.



Rope light power supply cable.
Kabel zasilający do węża.



5 set adapter to LED string lights, curtains and nets connection,
Rozgałęźnik do lampek, kurtynek i kurtyń.



Cable which is used to connect rope light with LED string lights.
Kabel do łączenia węża z lampkami.

Power supply.
Zasilacz 12V



Cross type connector for rope.
Czwórnik do łączenia węża.



„T” type connector.
Trójnik do łączenia węża.



White and blue cables.
Przewody w wersji białej i niebieskiej.



Professional rope light control unit
Profesjonalny Programator do węży
Waterfall function, 1.5m of 2A power supply cable with 3 pin rope light connector. / Z funkcją wodospadu, z kablem zasilającym 1,5 m i złączką 3-pinową do węża. 2A. POL-C NK3



Cross type connector
Czwórnik do łączenia węża
Waterproof connector which is used to rope light connection.
Wodoszczelna złączka do łączenia węża. Zestaw. POL-PCC

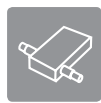

Rope light control unit
Programator do węży
1.5m of 2A power supply cable with 2 pin rope light connector. Works up to 100m. / Z kablem zasilającym 1,5 m i złączką 2-pinową do węża. 2A - sterowanie wężem do 100 m długości. POL-C NK1, NK2



„T” type connector
Trójnik „T” do łączenia węża
Waterproof connector which is used to rope light connection.
Wodoodporna złączka typu „T” (trójnik) do łączenia węża. Zestaw. POL-PCT



Rope light power supply cable
Kabel zasilający do węża
1.5 m cable with 2 or 3 pin rope light connector. Indoor use only. 1,5 m z płaską wtyczką ze złączką 2-pinową lub 3-pinową do węża. Tylko do stosowania wewnątrz. POL-PCL



Arterial connector
Przelotka do łączenia węży
For NK1, NK2, NK3 rope.
Do łączenia węża z wężem NK1, NK2, NK3. POL-PCI



Rope light PRO power supply cable
Kabel Pro zasilający do węża
1.5 m cable with 2 or 3 pin rope light connector. Waterproof, outdoor use. / 1,5 m z okrągłą wtyczką ze złączką 2/3-pinową do węża. Wodoodporny do stosowania na zewnątrz. POL-PPCL



„L” type connector
Dwójnik „L” do łączenia węża
Waterproof connector which is used to rope light connection.
Wodoodporna złączka typu „L” (dwójnik) do węża. Zestaw. POL-PCL



2 pin rope light connector
2-pinowa złączka metalowa
For NK1 and NK2 rope light connection with power supply cable.
Do łączenia węża NK1, NK2 z kablem zasilającym. POL-SCRPC



Female arterial connector
Przelotka wąż-lampki żeńska
Connector which is used for rope light and LED string lights connection. / Do łączenia węża z lampki ŻEŃSKA. POL-SCRSW



3 pin rope light connector
3-pinowa złączka metalowa
For connecting rope light to power supply.
Do łączenia węża z kablem zasilającym. POL-SCRPCNK3



Male arterial connector
Przelotka wąż-lampki męska
Connector which is used for rope light and LED string lights connection. / Do łączenia węża z lampki MĘSKA. POL-SCRSM



2 pin rope light connector
2-pinowa złączka metalowa
For connecting NK1 and NK2 rope lights together.
Do łączenia węża z wężem NK1, NK2. POL-SCRR



PRO cable 0.5m
Kabel Pro wąż-lampki 0,5m
Cable which is used to connect rope light with LED string lights. Suitable for outdoor use. White colour. / Do łączenia węża z lampkami, 0,5 m. Biały. Na zewnątrz. POL-KSRL-W-0,5

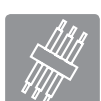

3 pin rope light connector
3-pinowa złączka metalowa
For connecting NK3 rope light together.
Do łączenia węża z wężem NK3. POL-SCRRNK3



PRO cable 1.5m
Kabel Pro wąż-lampki 1,5m
Cable which is used to connect rope light with LED string lights. Suitable for outdoor use. Green colour. / Do łączenia węża z lampkami, 1,5 m. Zielony. Na zewnątrz. POL-KSRL-G-1,5



Rope light grip
Uchwyt do węża
U type plastic grip.
Plastikowy typ „U”. POL-H



PRO cable 3.0m
Kabel Pro wąż-lampki 3m
Cable which is used to connect rope light with LED string lights. Suitable for outdoor use. Green colour. / Do łączenia węża z lampkami, 3,0 m Zielony. Na zewnątrz. POL-KSRL-G-3,0



Rope light plug
Zasleпка do węża
NK1, NK2, NK3
POL-E



PRO cable 5.0m
Kabel Pro wąż-lampki 5m
Cable which is used to connect rope light with LED string lights. Suitable for outdoor use. Green colour. / Do łączenia węża z lampkami, 5,0 m Zielony. Na zewnątrz. POL-KSRL-G-5,0



Green/white TK160/3 tie
Opaska TK160/3 zielona/biała
100 pcs, outdoor use.
100 szt. Na zewnątrz. POL-TK16/3-G / POL-TK16/3



Heat shrink tube with glue
Koszulka termokurczliwa z klejem
Ø19mm/Ø10cm transparent. / Ø19mm/10cm przezroczysta. POL-RC3K



2 pin plastic connector
2-pinowa złączka plastikowa
For connecting NK1, NK2, NK3 rope lights together.
Do łączenia węża z wężem NK1, NK2, NK3. POL-PC



Heat shrink tube
Koszulka termokurczliwa
19/9,5 1m
POL-HS19/9,5



2 pin plastic connector
2-pinowa złączka plastikowa
For connecting NK1, NK2, NK3 rope lights to power supply.
Do łączenia węża NK1, NK2, NK3 z kablem zasilającym. POL-PCCR



Professional glue
Profesjonalny klej
POL-G

LED NEON ROPE LIGHT ACCESSORIES / AKCESORIA DO WĘŻY LED NEON

	<p>Rope light PRO power supply cable Kabel Pro zasilający do węża</p> <p>1.5 m cable with 2 pin NEON rope light connector. Waterproof, suitable for outdoor use. / NEON 1,5 m z okrągłą wtyczką ze złączką 2-pinową do węża NEON. Na zewnątrz. POL-PPCLNF</p>		<p>Mounting clip Klip montażowy</p> <p>POL-MCNF</p>
	<p>Rope light mounting flume Kanał montażowy do węża</p> <p>NEON POL-AMCNF</p>		<p>Plastic NEON rope light plug Zaślepka do węża</p> <p>NEON POL-ENF</p>
	<p>2 pin rope light connector 2-pinowa złączka metalowa</p> <p>For NEON rope light connection with power supply cable. Do łączenia węża NEON z kablem zasilającym. POL-SCRPCNF</p>		<p>2 pin rope light connector 2-pinowa złączka metalowa</p> <p>For connecting NEON rope lights together. Do łączenia węża z wężem NEON. POL-SCRRNF</p>
	<p>straight nulator Dwójnik prosty</p> <p>NEON rope light waterproof connector. Wodoodporna złączka do węża NEON. Zestaw. POL-PCINF</p>		<p>„L” type plastic flat nullator Dwójnik płaski typu „L”</p> <p>Special waterproof NEON rope light connector. Wodoodporna złączka typu „L” płaska do węża NEON. Zestaw. POL-FPCLNF</p>
	<p>T” type connector Trójnik typu „T”</p> <p>Waterproof connector which is used to NEON rope light connection. Wodoodporna złączka typu „T” do węża NEON. Zestaw. POL-PCTNF</p>		<p>Cross type connector Czwórnik do łączenia węża</p> <p>Waterproof connector which is used to NEON rope light connection. Wodoodporna złączka typu „T” do węża NEON. Zestaw. POL-PCCNF</p>
	<p>Professional NEON rope light glue Profesjonalny klej do w. NEON</p> <p>POL-G 227g</p>		

LED LIGHT, CURTAIN AND OTHER ACCESSORIES AKCESORIA DO LAMPEK, KURTYN, KURTYNEK, INNE

	<p>PRO cable 0.5m Kabel Pro lampki-lampki 0,5m</p> <p>Cable which is used to connect together LED string lights. Suitable for outdoor use. Green colour. / Do łączenia lampek z lampkami, 0,5 m Zielony. Na zewnątrz. POL-KSS-G-0,5</p>		<p>„T” type cable Trójnik przewód</p> <p>3x0.5m for christmas lights, curtains and LED nets. Do łączenia lampek choinkowych, kurtynek, kurtyń i siatek led. POL-PRZEDTROI</p>
	<p>PRO cable 1.5m Kabel Pro lampki-lampki 1,5m</p> <p>Cable which is used to connect together LED string lights. Suitable for outdoor use. Green colour. / Do łączenia lampek z lampkami, 0,5 m Zielony. Na zewnątrz. POL-KSS-G-1,5</p>		<p>5 set adapter Rozgałęźnik do 5 kompletów</p> <p>To LED string lights, curtains and nets connection, 1 input, 5 outputs. Do łączenia lampek choinkowych, kurtynek, kurtyń i siatek LED. 1 wejście – 5 wyjść. POL-ROZ6</p>
	<p>PRO cable 3.0m Kabel Pro lampki-lampki 3,0m</p> <p>Cable which is used to connect together LED string lights. Suitable for outdoor use. Green colour. / Do łączenia lampek z lampkami, 0,5 m Zielony. Na zewnątrz. POL-KSS-G-3,0</p>		<p>3 set adapter Rozgałęźnik do 3 kompletów</p> <p>To LED lights, curtains and nets connection, 1 input, 3 outputs. Do łączenia lampek choinkowych, kurtynek, kurtyń i siatek LED. 1 wejście – 3 wyjścia POL-ROZ3</p>
	<p>PRO cable 5.0m Kabel Pro lampki-lampki 5,0m</p> <p>Cable which is used to connect together LED string lights. Suitable for outdoor use. Green colour. / Do łączenia lampek z lampkami, 0,5 m Zielony. Na zewnątrz. POL-KSS-G-5,0</p>		<p>30m steel tape Taśma stalowa</p> <p>30 m POL-SS</p>
	<p>Curtain extension cable Przewód rozszerzający</p> <p>Cable with 3 light sockets to curtain creation. do samodzielnego tworzenia kurtyń z 3 gniazdami na lampki POL-SE3S</p>		<p>Steel tape tensioner Napinacz do taśmy</p> <p>POL-DT</p>
	<p>Curtain creation cable Kabel do tworzenia kurtyń</p> <p>Cable with 20 light sockets 2.5m + 1.5m power supply cable, spaces each 10cm. / Z 20 gniazdami, 2,5 m + 1,5 kabel zasilający, odstępy co 0,1 m. POL-SE25S</p>		<p>Lantern decoration handle Uchwyt do ozdób latarniowych</p> <p>POL-SH</p>

E27 LAMP GARLANDS

GIRLANDY NA ŻARÓWKI E27

They can be used to decorate trees, bushes, windows, and to hang above squares, or any other arrangement of a given area. It is possible to use bulbs of any colour, as well as flash bulbs which add an extra effect. The lights can be used in low temperatures or high air humidity. A new feature includes an additional gummi connector to connect the garland with another one.

Mogą mieć zastosowanie do zdobienia choinek, drzew, krzewów, okien, wolnej przestrzeni nad skwerami, placami oraz do dowolnej aranżacji terenu. Do gniazd można zamontować żarówki o dowolnej kolorystyce + żarówki flash, które dodają efektu. Lampki można stosować w niskich temperaturach i przy dużej wilgotności powietrza. Nowością jest zastosowanie dodatkowego gniazda do połączenia z inną girlandą (typ gummi).



E27 GARLAND PRO 10 BLACK
GIRLANDA NA ŻARÓWKI E27 PRO 10 CZARNA

Quality / Jakość	high / wysoka
Flexibility / Elastyczność	super
UV resistance / Odporność na UV	yes / tak
Protection Rating / Stopień szczelności	IP65
Color / Kolor	black / czarny
Socket / Trzonek	E27
Quantity of sockets / Ilość gniazd	10
Length / Długość	11,5 m
Socket spacing / Odległość między gniazdami	1 m
Additional connec. pieces / Dodatkowa złączka	yes / tak (gummi)
Voltage / Zasilanie	230V

Index: POL-E27BL10-10-BL



OUTDOOR USE



E27 GARLAND PRO 20 BLACK OR WHITE
GIRLANDA NA ŻARÓWKI E27 PRO 20 CZARNA/BIAŁA

Quality / Jakość	high / wysoka
Flexibility / Elastyczność	super
UV resistance / Odporność na UV	yes / tak
Protection Rating / Stopień szczelności	IP65
Color / Kolor	black/white / czarny/biały
Socket / Trzonek	E27
Quantity of sockets / Ilość gniazd	20
Length / Długość	21,5 m
Socket spacing / Odległość między gniazdami	1 m
Additional connec. pieces / Dodatkowa złączka	yes / tak (gummi)
Voltage / Zasilanie	230V

Index: POL-E27BL20-20-BL POL-E27BL20-20-W



OUTDOOR USE



E27 GARLAND PRO 40 BLACK
GIRLANDA NA ŻARÓWKI E27 PRO 40 CZARNA

Quality / Jakość	high / wysoka
Flexibility / Elastyczność	super
UV resistance / Odporność na UV	yes / tak
Protection Rating / Stopień szczelności	IP65
Color / Kolor	black / czarny
Socket / Trzonek	E27
Quantity of sockets / Ilość gniazd	40
Length / Długość	21,5 m
Socket spacing / Odległość między gniazdami	0,5 m
Additional connec. pieces / Dodatkowa złączka	yes / tak (gummi)
Voltage / Zasilanie	230V

Index: POL-E27BL20-40-BL



OUTDOOR USE



COMPONENTS FOR E27 GARLANDS / KOMPONENTY DO PRODUKCJI GARLAND Z GNIAZDEM E27

CABLE FOR MAKING GARLANDS
KABEL DO TWORZENIA GIRLANDY
POL-E27BL-CAB



PLUG FOR FLAT CABLE GARLAND E27
WTYCZKA DO PŁASKIEJ GIRLANDY E27
POL-PLUGGARLAND-BL



SOCKET GUMMI FOR FLAT CABLE E27
GNIAZDO DO PŁASKIEJ GIRLANDY E27
POL-PLUG-SOC GARLAND-BL

GARLAND SOCKET E27
OPRAWKA E27 DO TWORZENIA GIRLANDY
POL-E27BL-SOC

HOOK FOR FLAT CABLE
HAK DO PŁASKIEJ GIRLANDY E27
POL-PLUG-HOOK GARLAND-BL

MONSTRUM, WHITE PROJECTORS

PROJEKTORY MONSTRUM, WHITE

POLAMP produces projectors which are a part of image projection systems. The use of the newest technological solutions allows us to create efficient, reliable, and energy-saving equipment.

We are able to adjust graphics, photos, and ornaments to your expectations. We offer static or animated images. Also, we have a wide range of accessories such as lenses, prisms, mounts, rotation mechanisms, colourful covers, and image changers.

POLAMP equipment is used by building administrators, sports halls and shopping centres owners. We delivered various light patterns to landscape architects, and we also illuminated streets, trees, or churches many times. The most visible and effective instances of illumination can be seen on building facades. It is currently becoming more and more popular on the walls of municipal and commune offices. Things which delight include colour scheme, selection of motifs, and range of projected light. Children can gaze at moving stars and glowing baubles for hours. Adults are not indifferent to decorations as such.

Christmas season gained an entirely new dimension. POLAMP meets the contemporary needs and aesthetic feeling.

POLAMP produkuje projektory będące częścią systemów oświetlenia obrazem. Wykorzystanie najnowocześniejszych technologicznych rozwiązań pozwala tworzyć nam sprzęt wydajny, stabilny w działaniu i energooszczędny.

Jesteśmy w stanie dopasować grafiki, zdjęcia, ornamenty do Twoich oczekiwań. Oferujemy obrazy statyczne lub animowane. Posiadamy też szeroką ofertę akcesoriów, od obiektywów i przyrządów, przez mocowania i mechanizmy obracania, po nakładki koloru i zmienniki obrazu.

Ze sprzętu POLAMP korzystają zarządcy budynków, właściciele hal sportowych i centrów handlowych. Różne światne wzory zamawiali u nas architekci krajoznawstwa, oświetlaliśmy nie raz ulice, drzewa, kościoły. Najbardziej widoczne i efektowne są jednak na fasadach budynku, coraz to popularniejsze szczególnie na ścianach urzędów miast i gmin. Zachwycają kolorystyką, doborem motywów i zasięgiem światła emitowanego przez projektor. Dzieci godzinami potrafią się wpatrywać w poruszające się gwiazdki, świecące wzory bombek. Dorosli także nie są obojętni wobec takich dekoracji.

Sezon związany ze świętami Bożego Narodzenia zyskał zupełnie inny wymiar. POLAMP wychodzi naprzeciw współczesnemu zapotrzebowaniu i poczuciu estetyki.

RANGE
28m

15m

GOBOS
54mm

LED
CREE

IP
65

360°

* Monstrum 100





LED PROJECTOR MONSTRUM 100
PROJEKTOR LED MONSTRUM 100

100 W **230 V** **12000 lm** **6500 K** **RANGE 28m** **15m** **LED CREE** **IP 65** **GOBOS 54mm** **360°** **A**

Power / Moc	100W
Voltage / Zasilanie	230V
Protection Rating / Stopień szczelności	IP65
Luminous / Strumień świetlny	12 000 lm
Color temperature / Barwa światła	6500K
Lighting range / Zasięg świecenia	28 m
Max projection size / Maks. wielkość obrazu	15 m
Rotation / Rotacja	yes / tak (360°)
Gobos	54mm
Housing / Obudowa	aluminum / aluminium

Index: POL-MONSTRUM100W

POWERlight

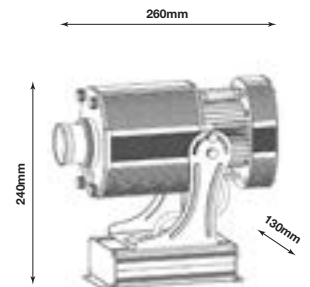

LED PROJECTOR MONSTRUM 80
PROJEKTOR LED MONSTRUM 80

80 W **230 V** **10000 lm** **6500 K** **RANGE 21m** **12m** **LED CREE** **IP 65** **GOBOS 54mm** **360°** **A**

Power / Moc	80W
Voltage / Zasilanie	230V
Protection Rating / Stopień szczelności	IP65
Luminous / Strumień świetlny	10 000 lm
Color temperature / Barwa światła	6500K
Lighting range / Zasięg świecenia	21 m
Max projection size / Maks. wielkość obrazu	12 m
Rotation / Rotacja	yes / tak (360°)
Gobos	54mm
Housing / Obudowa	aluminum / aluminium

Index: POL-MONSTRUM80W

POWERlight

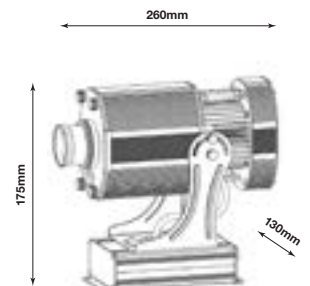

80/100W outdoor LED projector. It is suitable for the simultaneous use of 2 gobos. Thanks to its projecting distance it is possible to illuminate large objects. The projector is weather proof. We also offer a wide choice of gobos for different occasions.

Projektor LED na zewnątrz o mocy 100/80W. Umożliwia jednoczesne użycie 2 gobosów. Dystans świecenia pozwala na oświetlenie dużych obiektów. Projektor jest odporny na warunki atmosferyczne. W ofercie posiadamy dużą ilość gobosów na różne okazje.





A sample gobo with Christmas motive.

Przykładowy gobos z motywem świątecznym.

Remote controller for monstrum projector.

Pilot do projektora Monstrum.



POL-MONSTRUM RC PILOT

Example of optional gobos for the projector
Przykłady opcjonalnych gobosów do projektora

1 color / 1 kolor

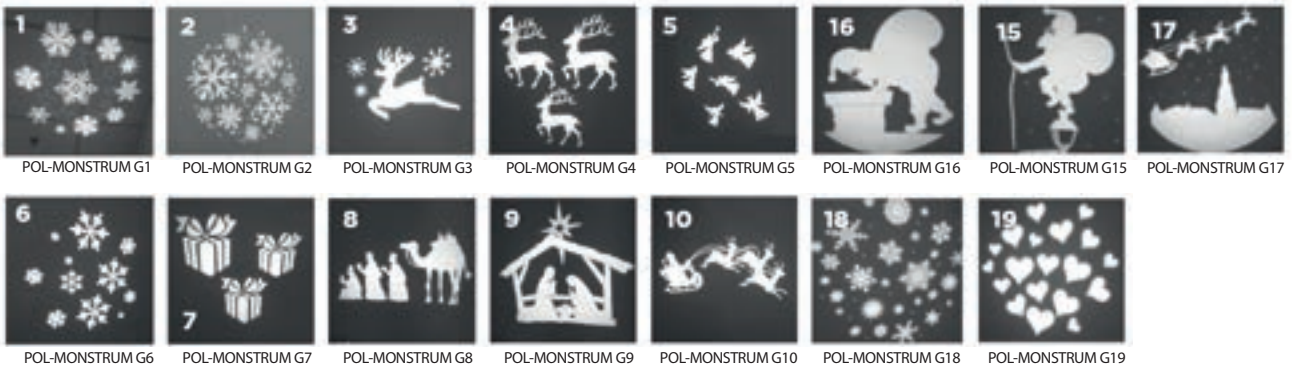

2 colors / 2 kolory

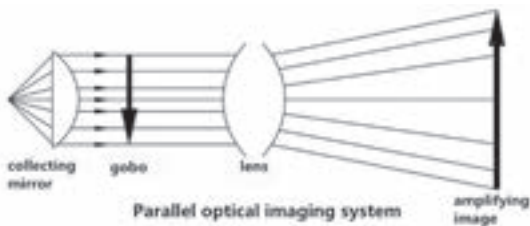



WHITE PROJECTOR 12W
PROJEKTOR WHITE 12W

12 W 24 V LED ABS RANGE 15m IP 44 SENSOR A

POWERlight

Power / Moc	12W
Voltage / Zasilanie	24V
Protection Rating / Stopień szczelności	IP44
Lighting range / Zasięg świecenia	15 m
Rotation / Rotacja	yes / tak
Dawn sensor / Czujnik zmierzchu	yes / tak
Housing / Obudowa	ABS
Power cable / Kabel zasilający	5m

Index: POL-PRO1-SN

A projector with the falling snowflakes or stars effect. Range up to 15 m. Built-in dusk/dawn sensor. 5-metre-long power cord. Weatherproof. Perfect for garden use.

Projektor z efektem spadających śnieżynek, gwiazdek. Zasięg do 15 m. Wbudowany czujnik zmierzchu. Kabel zasilający 5m. Odporny na warunki atmosferyczne. Idealny do ogrodu.



Includes power supply 24V and a tripod.

W zestawie zasilacz 24V oraz statyw.



G45 LED COLOR BULBS

LAMPY LED G45 KOLOROWE



LED BULB G45 E27 1W, GREEN LAMPA LED G45 E27 1W ZIELONA

Power / Moc	1 W
Voltage / Zasilanie	230V
Socket / Trzonek	E27
Color temperature / Barwa światła	green / zielona
Luminous / Strumień świetlny	70 lm
Life span / Czas pracy	25000h

Index: POL G45 E27 1WG

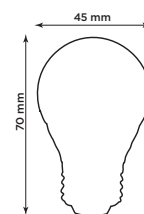
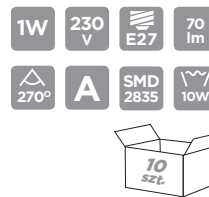

LED BULB G45 E27 1W, BLUE LAMPA LED G45 E27 1W NIEBIESKA

Power / Moc	1 W
Voltage / Zasilanie	230V
Socket / Trzonek	E27
Color temperature / Barwa światła	blue / niebieska
Luminous / Strumień świetlny	70 lm
Life span / Czas pracy	25000h

Index: POL G45 E27 1WBLU

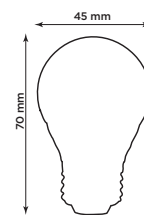
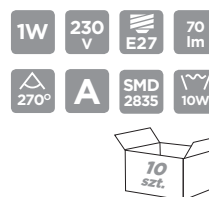

LED BULB G45 E27 1W, RED LAMPA LED G45 E27 1W CZERWONA

Power / Moc	1 W
Voltage / Zasilanie	230V
Socket / Trzonek	E27
Color temperature / Barwa światła	red / czerwona
Luminous / Strumień świetlny	70 lm
Life span / Czas pracy	25000h

Index: POL G45 E27 1WR

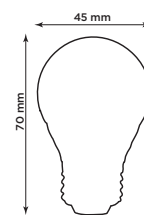
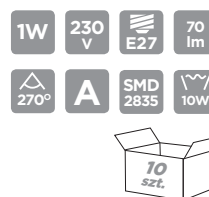

LED BULB G45 E27 1W, YELLOW LAMPA LED G45 E27 1W ŻÓŁTA

Power / Moc	1 W
Voltage / Zasilanie	230V
Socket / Trzonek	E27
Color temperature / Barwa światła	yellow / żółta
Luminous / Strumień świetlny	70 lm
Life span / Czas pracy	25000h

Index: POL G45 E27 1WY

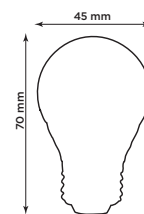
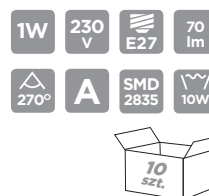

LED BULB G45 E27 1W, LIGHT GREEN LAMPA LED G45 E27 1W JASNA ZIELONA

Power / Moc	1 W
Voltage / Zasilanie	230V
Socket / Trzonek	E27
Color temperature / Barwa światła	light green / jasna zielona
Luminous / Strumień świetlny	70 lm
Life span / Czas pracy	25000h

Index: POL G45 E27 1WLG

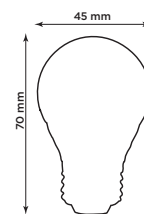
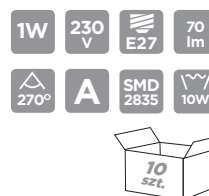

LED BULB G45 E27 1W, ORANGE LAMPA LED G45 E27 1W POMARAŃCZOWA

Power / Moc	1 W
Voltage / Zasilanie	230V
Socket / Trzonek	E27
Color temperature / Barwa światła	orange / pomarańczowa
Luminous / Strumień świetlny	70 lm
Life span / Czas pracy	25000h

Index: POL G45 E27 1WO

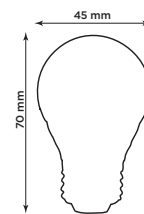
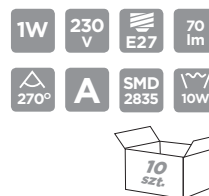



LED BULB G45 E27 1W, PINK
LAMPA LED G45 E27 1W RÓŻOWA

Power / Moc	1 W
Voltage / Zasilanie	230V
Socket / Trzonek	E27
Color temperature / Barwa światła	pink/ różowa
Luminous / Strumień świetlny	70 lm
Life span / Czas pracy	25000h

Index: POL G45 E27 1W P

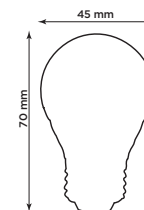

LED BULB G45 E27 1W, SEA BLUE
LAMPA LED G45 E27 1W NIEBIESKA MORSKA

Power / Moc	1 W
Voltage / Zasilanie	230V
Socket / Trzonek	E27
Color temperature / Barwa światła	sea blue / niebieska morska
Luminous / Strumień świetlny	70 lm
Life span / Czas pracy	25000h

Index: POL G45 E27 1W SBLU

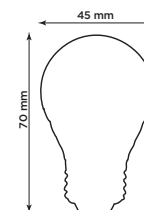

LED BULB G45 E27 1W, COLD WHITE
LAMPA LED G45 E27 1W BIAŁA ZIMNA

Power / Moc	1 W
Voltage / Zasilanie	230V
Socket / Trzonek	E27
Color temperature / Barwa światła	cold white / biała zimna
Luminous / Strumień świetlny	70 lm
Life span / Czas pracy	25000h

Index: POL G45 E27 1W CW

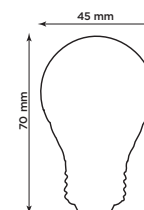

LED BULB G45 E27 1W, WARM WHITE
LAMPA LED G45 E27 1W BIAŁA CIEPŁA

Power / Moc	1 W
Voltage / Zasilanie	230V
Socket / Trzonek	E27
Color temperature / Barwa światła	warm white / biała ciepła
Luminous / Strumień świetlny	70 lm
Life span / Czas pracy	25000h

Index: POL G45 E27 1W WW

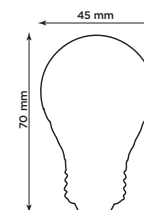

LED BULB G45 E27 1W, WARM WHITE TRANSPARENT SH.
LAMPA LED G45 E27 1W BIAŁA CIEPŁA, PRZEZROCZYSTY KLOSZ

Power / Moc	1 W
Voltage / Zasilanie	230V
Socket / Trzonek	E27
Color temperature / Barwa światła	warm white / biała ciepła
Luminous / Strumień świetlny	70 lm
Life span / Czas pracy	25000h

Index: POL G45 E27 1W WW T

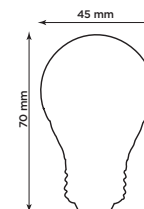

LED BULB G45 E27 1W, NEUTRAL WHITE
LAMPA LED G45 E27 1W BIAŁA NEUTRALNA

Power / Moc	1 W
Voltage / Zasilanie	230V
Socket / Trzonek	E27
Color temperature / Barwa światła	neutral white / biała neutralna
Luminous / Strumień świetlny	70 lm
Life span / Czas pracy	25000h

Index: POL G45 E27 1W NW

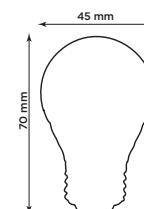

LED MODULES AND STRIPS

MODUŁY I TAŚMY LED

LED modules and strips are a practical solution when you are planning to install precise lighting system, light a small space, or install a uniquely-shaped illumination.

In addition, LED strips are self-adhesive, which helps to install them firmly at a selected location or in special aluminium profiles more often. Dedicated profiles also have a protective function for LEDs. LED strips are slim and long, at marked spots it is possible to cut them (every 5 cm). As a result, they can be used as a source of main or supplementary light. POLAMP offers waterproof LED modules and strips (IP68 and IP65), which are useful for outdoor use, car decorations, or bathroom lighting. Since they are waterproof, they are also easier to maintain, therefore they are more durable. IP20 strips are used in interiors to illuminate furniture, suspended ceilings, etc. LED modules can be controlled, thanks to which we can create interesting light animation effects.

Moduły i taśmy LED są praktycznym rozwiązaniem, gdy planujesz montaż precyzyjnego oświetlenia, chcesz doświetlić jakąś małą przestrzeń, czy zainstalować iluminację świetlną o kształcie zupełnie innym, niż dają lampy i żarówki.

Dodatkowo taśmy LED są samoprzylepne. Pomaga to w trwałym przymocowaniu, czego dokonuje się bezpośrednio w wybranym miejscu, albo częściej w specjalnych profilach aluminiowych. Profile do taśm pełnią dodatkowe funkcje ochronne dla diod LED. Taśmy LED są wąskie i długie a w wyznaczonych miejscach można je przeciąć (co 5 cm). Dzięki temu z powodzeniem służą nie tylko oświetlaniu, ale i podświetlaniu. W ofercie POLAMP znajdziesz moduły i taśmy LED wodoodporne (IP68 i IP65), przydatne na zewnątrz, też do tuningu samochodów lub np. w łazience. Warto zwrócić uwagę, że odporność na wodę ułatwia konserwację produktu, a zatem przedłuża jego żywotność. Paski o niższej klasie odporności (IP20), stosuje się we wnętrzach, przy podświetlaniu mebli, do podwieszanych sufitów itd. Moduły LED mogą być sterowane dzięki czemu możemy uzyskać ciekawe efekty animacji światłem.



We produce 12V LED strips in different power variants - from 4,8W/m to 19W/m. Warm white and cool white colour temperatures available. Our modules power variants range from 0,3W to 2W, and they can have 1, 2, 3, or 4 LEDs. We also offer RGB modules.

Noteworthy items in our offer of LED lighting include POWERlight products, which are characterised by high density of LEDs. As a result, they emit more light than standard variants.

Produkujemy taśmy LED o mocy od 4,8 do 19W/m. Działają na napięciu 12V i świecą w dwóch temperaturach barwowych, białej zimnej lub białej ciepłej. Nasze moduły mają moc od 0,3 do 2 W i mogą być 1-, 2-, 3- i 4-diodowe. Posiadamy też w ofercie moduły RGB.

W ofercie LED naszej marki wyróżniamy produkty POWERlight. Cechują je gęsto ułożone diody, dzięki czemu emitują więcej światła, niż standardowy rozstaw.





LED MODULE 4 EYES, 30 PCS/CORD
MODUŁ LED 4 EYES, 30 szt/przewód

2W 12 V 180 lm RA >80 160° IP 65 A



LED type Typ diody	Color temperature Barwa światła	Voltage Zasilanie	Power Moc	Beam angle Kąt świecenia	Luminous Strumień świetl.	Protection Rating Stopień szczelności	Size mm Wymiar mm
2835	biała zimna	12 V DC	2 W	160°	180 lm	IP65	41x41

Index: UTW378B



LED MODULE 3 EYES, 40 PCS/CORD
MODUŁ LED 3 EYES, 40 szt/przewód

1,5 W 12 V 135 lm RA >80 160° IP 65 A



LED type Typ diody	Color temperature Barwa światła	Voltage Zasilanie	Power Moc	Beam angle Kąt świecenia	Luminous Strumień świetl.	Protection Rating Stopień szczelności	Size mm Wymiar mm
2835	biała zimna	12 V DC	1,5 W	160°	135 lm	IP65	70x18

Index: UTW377B



LED MODULE 2 EYES, 50 PCS/CORD
MODUŁ LED 2 EYES, 50 szt/przewód

1W 12 V 90 lm RA >80 160° IP 65 A



LED type Typ diody	Color temperature Barwa światła	Voltage Zasilanie	Power Moc	Beam angle Kąt świecenia	Luminous Strumień świetl.	Protection Rating Stopień szczelności	Size mm Wymiar mm
2835	biała zimna	12 V DC	1 W	160°	90 lm	IP65	48x18

Index: UTW376B



LED MODULE 1 EYE, 50 PCS/CORD
MODUŁ LED 1 EYE, 50 szt/przewód

0,5 W 12 V 45 lm RA >80 160° IP 65 A



LED type Typ diody	Color temperature Barwa światła	Voltage Zasilanie	Power Moc	Beam angle Kąt świecenia	Luminous Strumień świetl.	Protection Rating Stopień szczelności	Size mm Wymiar mm
2835	biała zimna	12 V DC	0,5 W	160°	45 lm	IP65	32x18

Index: UTW375B



LED MODULE 1 EYE RGB, 50 PCS/CORD MODUŁ LED 1 EYE RGB, 50 szt/przewód



LED type Typ diody	Color temperature Barwa światła	Voltage Zasilanie	Power Moc	Beam angle Kąt świecenia	Luminous Strumień świetl.	Protection Rating Stopień szczelności	Size mm Wymiar mm
5050	RGB	5-12 V DC	0,3 W	160°	30 lm	IP68	15x12

Index: POL-1 EYE RGB

UOW-332B
1,5W, 43x36 mm 125 lm



ULW-383B
3W, 57x33 mm 220 lm



PREMIUM 1,5 and 3W models are also available on request. We give 5 year guarantee on all our modules. Different LED colours and controllers available.

Na zamówienie dostępne są również moduły z serii PREMIUM o mocy 1,5 i 3 W. Na wszystkie nasze moduły dajemy 5 lat gwarancji. Dostępne sterowniki do animacji oświetlenia i inne kolory diod.



LED MODULE FOR PLAFOND 18W WKŁAD LED DO PLAFONÓW 18W



Voltage / Zasilanie	230V AC / 50Hz
Power / Moc	18 W
Protection Rating / Stopień szczelności	IP65
Color temperature / Barwa światła	neutr. white/ biała neutr.
Luminous / Strumień świetlny	1800 lm

Index: POL-MODEL18W840

POWERlight



Energy-saving LED module for high power plafond lamps. 85% less energy consumed in comparison with traditional equivalents. High light output. Light colour similar to daylight. Very durable

Energooszczędny wkład LED do plafonów dużej mocy. Zużywa 85% mniej energii niż tradycyjne źródła światła. Wysoka sprawność świetlna. Barwa zbliżona do naturalnej barwy dziennej. Bardzo długa żywotność.



MAX POWER PREMIUM LED STRIP TAŚMA LED MAX POWER PREMIUM



Power / Moc	19 W/mb
Voltage / Zasilanie	DC 12V +/- 5%
LED quantity / Ilość diod	120 LED/mb
LED type / Typ LED	SMD 2835
Color temperature / Barwa światła	warm white / biała ciepła
Luminous / Strumień świetlny	1800 lm/m
Beam angle / Kąt świecenia	120°
Protection Rating / Stopień szczelności	IP33
Life span / Czas pracy	50000h

Index: POL-RQM074A WW

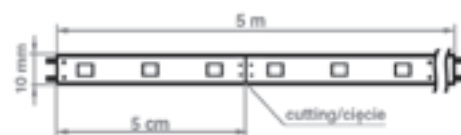

POWERlight



POWER PREMIUM LED STRIP TAŚMA LED POWER PREMIUM



Power / Moc	12 W/mb
Voltage / Zasilanie	DC 12V +/- 5%
LED quantity / Ilość diod	60 LED/mb
LED type / Typ LED	SMD 2835
Color temperature / Barwa światła	warm/cold white biała ciepła/zimna
Luminous / Strumień świetlny	1100 lm/m
Beam angle / Kąt świecenia	120°
Protection Rating / Stopień szczelności	IP33
Life span / Czas pracy	50000h

Index: POL-RQM072A WW POL-RQM072A CW

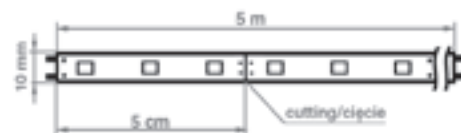

POWERlight



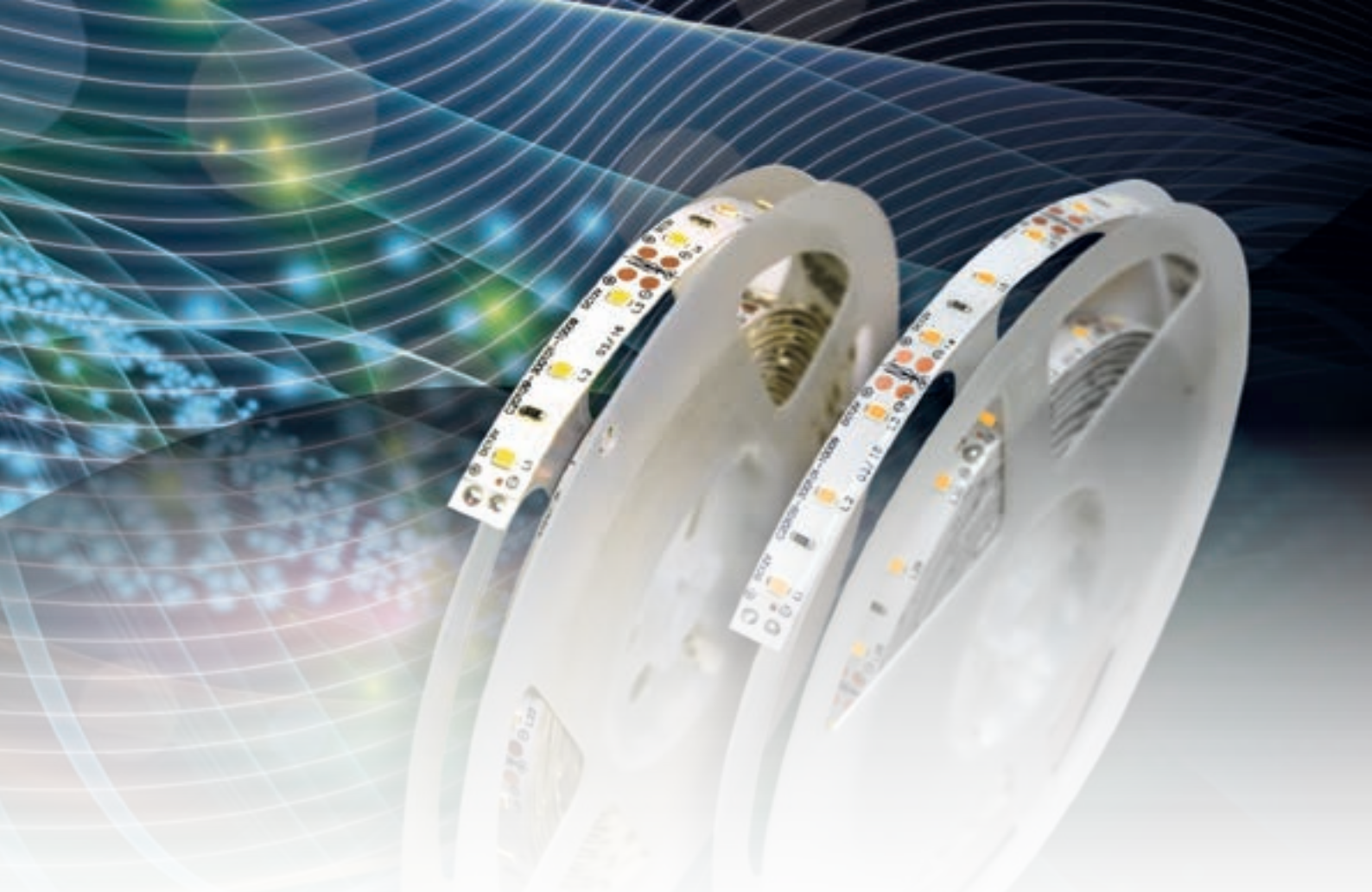

MAX PREMIUM LED STRIP TAŚMA LED MAX PREMIUM

8 W/m 12 V 900 lm/m 102 LED/m 5 m SMD 2835 120° IP 33 A 3000 K 6500 K

Power / Moc	8 W/mb
Voltage / Zasilanie	DC 12V +/- 5%
LED quantity / Ilość diod	102 LED/mb
LED type / Typ LED	SMD 2835
Color temperature / Barwa światła	warm/cold white biała ciepła/zimna
Luminous / Strumień świetlny	900 lm/m
Beam angle / Kąt świecenia	120°
Protection Rating / Stopień szczelności	IP33
Life span / Czas pracy	50000h

Index: POL-RQM096A WW POL-RQW096A CW

POWERlight

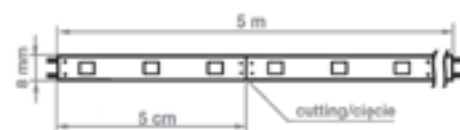

PREMIUM LED STRIP TAŚMA LED PREMIUM

6 W/m 12 V 500 lm/m 60 LED/m 5 m SMD 2835 120° IP 33 A 3000 K 6500 K

Power / Moc	6 W/mb
Voltage / Zasilanie	DC 12V +/- 5%
LED quantity / Ilość diod	60 LED/mb
LED type / Typ LED	SMD 2835
Color temperature / Barwa światła	warm/cold white biała ciepła/zimna
Luminous / Strumień świetlny	500 lm/m
Beam angle / Kąt świecenia	120°
Protection Rating / Stopień szczelności	IP33
Life span / Czas pracy	50000h

Index: POL-RQM062A WW POL-RQW062A CW

POWERlight





ECONOMIC LED STRIP TAŚMA LED ECONOMIC

6 W/m	12 V	400 lm/m	60 LED/m	5 m	SMD 2835	120°	IP 33	A	3000 K	6500 K
-------	------	----------	----------	-----	----------	------	-------	---	--------	--------

Power / Moc	6 W/mb
Voltage / Zasilanie	DC 12V +/- 5%
LED quantity / Ilość diod	60 LED/mb
LED type / Typ LED	SMD 2835
Color temperature / Barwa światła	warm/cold white biała ciepła/zimna
Luminous / Strumień świetlny	400 lm/m
Beam angle / Kąt świecenia	120°
Protection Rating / Stopień szczelności	IP33
Life span / Czas pracy	50000h

Index: POL-RQW062ACHWW POL-RQW062ACHWW

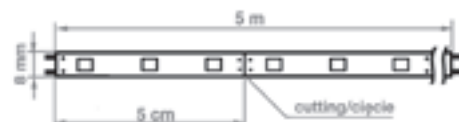

POWERlight



AQUA PREMIUM LED STRIP TAŚMA LED AQUA PREMIUM

6 W/m	12 V	500 lm/m	60 LED/m	5 m	SMD 2835	120°	IP 65	A	3000 K	6500 K
-------	------	----------	----------	-----	----------	------	-------	---	--------	--------

Power / Moc	6 W/mb
Voltage / Zasilanie	DC 12V +/- 5%
LED quantity / Ilość diod	102 LED/mb
LED type / Typ LED	SMD 2835
Color temperature / Barwa światła	warm/cold white biała ciepła/zimna
Luminous / Strumień świetlny	500 lm/m
Beam angle / Kąt świecenia	120°
Protection Rating / Stopień szczelności	IP65
Life span / Czas pracy	50000h

Index: POL-EQM062A WW POL-EQM062A CW

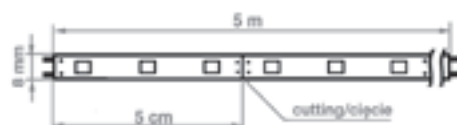

POWERlight



IP33



IP65



Aqua series strips have additional protection (IP65). As a result, they are completely waterproof.

Taśmy z serii Aqua posiadają dodatkowe zabezpieczenie (IP65). Dzięki niemu są całkowicie wodoszczelne.

AQUA STANDARD LED STRIP TAŚMA LED AQUA STANDARD

4,8 W/m	12 V	280 lm/m	60 LED/m	5 m	SMD 3528	120°	IP 65	A	3000 K	6500 K
------------	---------	-------------	-------------	--------	-------------	------	----------	---	-----------	-----------

Power / Moc	4,8 W/mb
Voltage / Zasilanie	DC 12V +/- 5%
LED quantity / Ilość diod	60 LED/mb
LED type / Typ LED	SMD 3528
Color temperature / Barwa światła	warm/cold white biała ciepła/zimna
Luminous / Strumień świetlny	280 lm/m
Beam angle / Kąt świecenia	120°
Protection Rating / Stopień szczelności	IP65
Life span / Czas pracy	50000h

Index: POL-LS3528/60-WW-IP65 POL-LS3528/60-CW-IP65

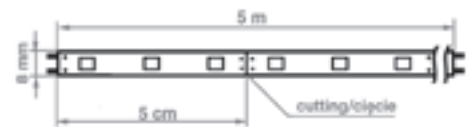

STANDARD LED STRIP TAŚMA LED STANDARD

4,8 W/m	12 V	280 lm/m	60 LED/m	10 m	SMD 3528	120°	IP 20	A	3000 K	6500 K
------------	---------	-------------	-------------	---------	-------------	------	----------	---	-----------	-----------

Power / Moc	4,8 W/mb
Voltage / Zasilanie	DC 12V +/- 5%
LED quantity / Ilość diod	60 LED/mb
LED type / Typ LED	SMD 3528
Color temperature / Barwa światła	warm/cold white biała ciepła/zimna
Luminous / Strumień świetlny	280 lm/m
Beam angle / Kąt świecenia	120°
Protection Rating / Stopień szczelności	IP20
Life span / Czas pracy	50000h

Index: POL-LS3528/60-WW POL-LS3528/60-CW

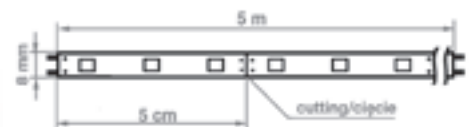

INDEX OF GIANT CONES, SMALL CHRISTMAS TREES, GARLANDS, AND ORNAMENTS
INDEKS STOŻKÓW GIGANTÓW, MAŁYCH CHOINEK, GIRLAND I OZDÓB CHOINKOWYCH

CONES/STOŻKI	STD40P 228	STD75 220	METALIZED MATS	VC NET / SIATKA PVC	XMAS TREES, WREATHS
STD01 201	STD41 216	STD76 214	MATY METALIZOWANE	POL-NETPVC-T 245	CHOINKI, WIANKI
STD01 6m 201	STD42 216	STD77 214	AY-01-BL 245		X2687-047 246
STD02 201	STD43 216	STD78 214	AY-01-BL 245		X2687-048 246
STD02 6m 201	STD44 216	STD79 214	AY-01-G 245	ANIMATED 3D FIGURES	X2687-050 246
STD03 201	STD45 216	STD79P 228	AY-01-GR 245	FIGURY ANIMOWANE 3D	X2687-051 246
STD03 6m 201	STD48 216	STD80 214	AY-01-GR-2 245	POLPU-001 250	X2716 E065 247
STD05 224	STD49 220	STD81 214	AY-01-PU 245	POLPU-002 250	X2716 E069 247
STD08 212	STD50 220	STD81P 228	AY-01-R 245	POLPU-003 250	X2716 E071 247
STD09 212	STD51 220	STD82 214	AY-01-S 245	POLPU-004 250	X2716 E072 247
STD12 224	STD52 221	STD83 214	AY-01-W 245	POLPU-005 250	X2716 G044 247
STD13 224	STD57 213	STD86 224	AY-01-Y 245	POLPU-006 250	X2716 G048 247
STD15 222	STD58 213	STD87 204		POLPU-007 250	X2716 G050 247
STD16 222	STD59 213	STD88 204	PREMIUM CHR. TREE	POLPU-008 250	X2716 G051 247
STD17 222	STD60 227	STD89 204	CT3111-6 244		X2716 T041 244
STD18 223	STD61 224	STD89P 228		STARS / GWIAZDY	X2716 T050 244
STD20 225	STD62 222	STD90 206		SD-WHY040 245	
STD21 222	STD64 222	STD90P 228	SINGLE BAUBLES		
STD22 226	STD65 220	STD91 206	BOMBKI POJEDYNCZE	BAUBLES ON WIRE	
STD24 222	STD66 216	STD92 206	POL-AY-B 245	BOMBKI NA SZNURZE	
STD27 219	STD67 226	STD93 208		SD-WY002 245	
STD28 217	STD68 226	STD94 208	WOOD ORNAMENTS		
STD30 224	STD69 226	STD95 208	DREWNIANE ORNAM.	SNOWFLAKE / ŚNIEŻYNKA	
STD31 224	STD70 226	STD95P 228	POL-DROR 245	SD-WYS024 245	
STD35 224	STD71 209	STD96 210			
STD39 218	STD72 220	STD97 210	OPTICAL FOIL	GARLANDS / GIRLANDY	
STD39P 228	STD73 220	STD98 210	FOLIA OPTYCZNA	TG3111-12 244	
STD40 222	STD73P 228	STD99 202	POL-FOLSTAR 1M 245	TG3111-2 244	
	STD74 220	STD100 203		TG3111-8 244	
				TG3111-9 244	



DETAILED PRODUCT LIST

LED STRING LIGHTS 6 M	284	LED WOODEN SLEIGH WITH RC 45 CM	299	LED CURTAINS 2,5X9M PRO	320	E27 GARLAND PRO 40 BLACK	351
LED STRING LIGHTS 10 M	284	LED WOODEN CHRISTMAS TREE WITH RC 40 CM	299	LED CURTAINS 5X0,5M PRO FLASH	322	LED PROJECTOR MONSTRUM 100	353
LED STRING LIGHTS 10 M	284	LED WOODEN CRIB WITH RC 45 CM	300	LED CURTAINS 5X1M PRO FLASH	322	LED PROJECTOR MONSTRUM 80	353
LED STRING LIGHTS PRO 10 M (5+5)	285	LED WOODEN LANTERNS WITH RC	300	LED CURTAINS 2,5X1,5M PRO FLASH	322	WHITE PROJECTOR 12W	355
LED STRING LIGHTS 10 M	285	LED ROPE LIGHT REINDEER	301	LED CURTAINS 2X2M PRO FLASH	323	LED BULB G45 E27 1W, GREEN	356
LED STRING LIGHTS PRO 10 M FLASH	285	LED SNOW FLAKE WITH SNOWFALL EFFECT	301	LED CURTAINS 2,5X3M PRO FLASH	323	LED BULB G45 E27 1W, BLUE	356
LED STRING LIGHTS PRO ALL FLASH	286	ICICLE LED CURTAINS	304	LED CURTAINS 2,5X6M PRO FLASH	324	LED BULB G45 E27 1W, RED	356
LED STRING LIGHTS 10 M	286	ICICLE LED CURTAINS FLASH	304	LED CURTAINS 2,5X9M PRO FLASH	324	LED BULB G45 E27 1W, YELLOW	356
LED STRING LIGHTS 24V PRO	287	ICICLE LED CURTAINS PRO	305	WATERFALL LED CURTAINS 2,5X3M	325	LED BULB G45 E27 1W, LIGHT GREEN	356
LED STRING LIGHTS 24V PRO FLASH	287	ICICLE LED CURTAINS PRO FLASH	305	WATERFALL LED CURTAINS 2,5X6M	326	LED BULB G45 E27 1W, ORANGE	356
LED STRING LIGHTS 24V	287	ICICLE LONG LED CURTAINS PRO	306	WATERFALL LED CURTAINS 2,5X3M PRO	326	LED BULB G45 E27 1W, PINK	357
LED STRING LIGHTS - SUPER DENSE	288	ICICLE LONG LED CURTAINS PRO FLASH	306	WATERFALL LED CURTAINS 2,5X6M PRO	327	LED BULB G45 E27 1W, SEA BLUE	357
SOLAR LED STRING LIGHTS 10 M	289	ICICLE VERY LONG LED CURTAINS PRO FLASH	307	LED NET LIGHTS 2X1M PRO	330	LED BULB G45 E27 1W, COLD WHITE	357
LED BALL STRING LIGHTS	290	ICICLE STAR LED CURTAINS	307	LED NET LIGHTS 2X1M PRO FLASH	330	LED BULB G45 E27 1W, WARM WHITE	357
LED BALL STRING LIGHTS RC	290	LED CURTAINS 5X0,5M	312	LED METEORS LIGHTS 20CM PRO	334	LED BULB G45 E27 W.W.WHITE TRANSP. SK.	357
LED BALL STRING LIGHTS RC PRO	291	LED CURTAINS 5X1M	312	LED METEORS LIGHTS 25CM PRO	334	LED BULB G45 E27 1W, NEUTRAL WHITE	357
LED BIG BALLS STRING LIGHTS RC PRO	291	LED CURTAINS 2,5X1,5M	312	LED METEORS LIGHTS 50CM PRO	334	LED MODULE 4 EYES, 30 PCS/CORD	359
LED STRING LIGHTS - STARS	292	LED CURTAINS 2,5X3M	313	LED METEORS LIGHTS 100CM PRO	335	LED MODULE 3 EYES, 40 PCS/CORD	359
LED STRING LIGHTS - SNOWFLAKES	293	LED CURTAINS 2,5X6M	314	LED STALACTITES	335	LED MODULE 2 EYES, 50 PCS/CORD	359
LED STRING LIGHTS - FLOWERS	293	LED CURTAINS 2,5X9M	314	LED ROPE PRO NK1 CUT LENGTH 2M	340	LED MODULE 1 EYE, 50 PCS/CORD	359
LED LIGHTS - CANDLE	293	LED CURTAINS 5X0,5M FLASH	315	LED ROPE PRO NK1 CUT LENGTH 1M	340	LED MODULE 1 EYE RGB, 50 PCS/CORD	360
TEARS STYLED LED LIGHTS RC 2M	294	LED CURTAINS 5X1M FLASH	315	LED ROPE PRO NK1 H CUT LENGTH 1M	341	LED MODULE FOR PLAFOND 18W	360
TEARS STYLED LED LIGHTS RC 3M	294	LED CURTAINS 2,5X1,5M FLASH	315	LED ROPE PRO NK1 H 24V CUT LENGTH 1M	341	MAX POWER PREMIUM LED STRIP	360
TEARS STYLED LED LIGHTS 2M	295	LED CURTAINS 2,5X3M FLASH	316	LED ROPE PRO NK3 CUT LENGTH 4M	341	POWER PREMIUM LED STRIP	360
TEARS STYLED LED LIGHTS 3M	295	LED CURTAINS 2,5X6M FLASH	317	LED ROPE PRO NK1 CUT LENGTH 2M FLASH	342	MAX PREMIUM LED STRIP	361
LED RATTAN BALLS 60	296	LED CURTAINS 2,5X9M FLASH	317	LED ROPE PRO NK1 H CUT LENGTH 1M FLASH	342	PREMIUM LED STRIP	361
LED WOOL BALLS 10	297	LED CURTAINS 5X0,5M PRO	318	BULB ROPE PRO NK1 CUT LENGTH 1M	342	ECONOMIC LED STRIP	362
LED WOOL BALLS 60	297	LED CURTAINS 5X1M PRO	318	LED ROPE NK1 TEST SAMPLE 2M	343	AQUA PREMIUM LED STRIP	362
LED WOODEN STAR WITH RC 40 CM	298	LED CURTAINS 2,5X1,5M PRO	318	NEON LED ROPE PRO NK1	344	AQUA STANDARD LED STRIP	363
LED WOODEN STAR WITH RC 60 CM	298	LED CURTAINS 2X2M PRO	319	E27 GARLAND PRO 10 BLACK	351	STANDARD LED STRIP	363
LED WOODEN STAR WITH RC 50 CM	298	LED CURTAINS 2,5X3M PRO	319	E27 GARLAND PRO 20 BLACK OR WHITE	351		
LED WOODEN STAR WITH RC 30 CM	299	LED CURTAINS 2,5X6M PRO	320				

SZCZEGÓŁOWY SPIS PRODUKTÓW

LAMPKI LED 6 M	284	DREWNIANE SANIE LED Z PILOTEM 45 CM	299	KURTYNY LED 2,5X9M PRO	320	GIRLANDA NA ŻARÓWKI E27 PRO 40 CZARNA	351
LAMPKI LED 10 M	284	DREWNIANA CHOINKA Z PILOTEM 40 CM	299	KURTYNY LED 5X0,5M PRO FLASH	322	PROJEKTOR LED MONSTRUM 100	353
LAMPKI LED 10 M	284	DREWNIANA SZOPKA LED Z PILOTEM 45 CM	300	KURTYNY LED 5X1M PRO FLASH	322	PROJEKTOR LED MONSTRUM 80	353
LAMPKI LED PRO 10 M (5+5)	285	DREWNIANE LAMPIONY LED Z PILOTEM	300	KURTYNY LED 2,5X1,5M PRO FLASH	322	PROJEKTOR WHITE 12W	355
LAMPKI LED FLASH 10 M	285	RENIFER Z WĘŻA LED	301	KURTYNY LED 2X2M PRO FLASH	323	LAMPKA LED G45 E27 1W ZIELONA	356
LAMPKI LED PRO 10 M FLASH	285	ŚNIEŻYNKA LED - SPADAJĄCY ŚNIEG	301	KURTYNY LED 2,5X3M PRO FLASH	323	LAMPKA LED G45 E27 1W NIEBIESKA	356
LAMPKI LED PRO 10 M WSZYSTKIE FLASH	286	KURTYNY LED	304	KURTYNY LED 2,5X6M PRO FLASH	324	LAMPKA LED G45 E27 1W CZERWONA	356
LAMPKI LED 10 M	286	KURTYNY LED FLASH	304	KURTYNY LED 2,5X9M PRO FLASH	324	LAMPKA LED G45 E27 1W ŻÓŁTA	356
LAMPKI LED 24V PRO 10 M (5+5)	287	KURTYNY LED PRO	305	KURTYNY LED Z EF WODOSPADU 2,5X3M	325	LAMPKA LED G45 E27 1W JASNA ZIELONA	356
LAMPKI LED 24V PRO 10 M (5+5) FLASH	287	KURTYNY LED PRO FLASH	305	KURTYNY LED Z EF WODOSPADU 2,5X6M	326	LAMPKA LED G45 E27 1W POMARAŃCZOWA	356
LAMPKI LED 24V	287	KURTYNY DŁUGIE LED PRO	306	KURTYNY LED Z EF WODOSPADU 2,5X3M PRO	326	LAMPKA LED G45 E27 1W RÓŻOWA	357
LAMPKI LED SUPER GĘSTE PRO 5 M	288	KURTYNY DŁUGIE LED PRO FLASH	306	KURTYNY LED Z EF WODOSPADU 2,5X6M PRO	327	LAMPKA LED G45 E27 1W NIEBIESKA MORSKA	357
LAMPKI Z PANELEM SŁONECZNYM LED 10 M	289	KURTYNY BARDZO DŁUGIE LED PRO FLASH	307	SIATKI LED 2X1M PRO	330	LAMPKA LED G45 E27 1W BIAŁA ZIMNA	357
LAMPKI LED KULKI	290	KURTYNY GWIAZDKI LED	307	SIATKI LED 2X1M PRO FLASH	330	LAMPKA LED G45 E27 1W BIAŁA CIEPŁA	357
LAMPKI LED KULKI Z PILOTEM	290	KURTYNY LED 5X0,5M	312	METEORKI LED 20 CM PRO	334	LAMPKA LED G45 E27 1W B. CIEPŁA, PRZEZ. KŁOSZ	357
LAMPKI LED KULKI PRO Z PILOTEM	291	KURTYNY LED 5X1M	312	METEORKI LED 25 CM PRO	334	LAMPKA LED G45 E27 1W BIAŁA NEUTRALNA	357
LAMPKI LED KULE BOMBY PRO Z PILOTEM	291	KURTYNY LED 2,5X1,5M	312	METEORKI LED 50 CM PRO	334	MODUŁ LED 4 EYES, 30 SZT/PRZEWÓD	359
LAMPKI LED Z ORNAMENTEM - GWIAZDKI	292	KURTYNY LED 2,5X3M	313	METEORKI LED 100 CM PRO	335	MODUŁ LED 3 EYES, 40 SZT/PRZEWÓD	359
LAMPKI LED Z ORNAMENTEM - ŚNIEŻYNKI	293	KURTYNY LED 2,5X6M	314	STALAKTYTY LED	335	MODUŁ LED 2 EYES, 50 SZT/PRZEWÓD	359
LAMPKI LED Z ORNAMENTEM - KWIATKI	293	KURTYNY LED 2,5X9M	314	WĄŻ ŚWIETLNY LED PRO NK1 CIĘTY CO 2M	340	MODUŁ LED 1 EYE, 50 SZT/PRZEWÓD	359
LAMPKI LED ŚWIECZKI	293	KURTYNY LED 5X0,5M FLASH	315	WĄŻ ŚWIETLNY LED PRO NK1 CIĘTY CO 1M	340	WRL-LED DO PLAFONÓW 18W	360
LAMPKI LED ŁĘZKI Z PILOTEM 2M	294	KURTYNY LED 5X1M FLASH	315	WĄŻ ŚWIETLNY LED PRO NK1 H CIĘTY CO 1M	341	TAŚMA LED MAX POWER PREMIUM	360
LAMPKI LED ŁĘZKI Z PILOTEM 3M	294	KURTYNY LED 2,5X1,5M FLASH	315	WĄŻ ŚWIETLNY LED PRO NK1 H 24V CIĘTY CO 1M	341	TAŚMA LED POWER PREMIUM	360
LAMPKI LED ŁĘZKI 2M	295	KURTYNY LED 2,5X3M FLASH	316	WĄŻ ŚWIETLNY LED PRO NK3 CIĘTY CO 4M	341	TAŚMA LED MAX PREMIUM	361
LAMPKI LED ŁĘZKI 3M	295	KURTYNY LED 2,5X6M FLASH	317	WĄŻ ŚWIETLNY LED PRO NK1 CIĘTY CO 2M FLASH	342	TAŚMA LED PREMIUM	361
KULKI RATANOWE 60	296	KURTYNY LED 2,5X9M FLASH	317	WĄŻ ŚWIETLNY LED PRO NK1 H CIĘTY CO 1M FLASH	342	TAŚMA LED ECONOMIC	362
KULKI BAWELNIANE LED 10	297	KURTYNY LED 5X0,5M PRO	318	WĄŻ ŚWIETLNY ŻARÓW. PRO NK1 CIĘTY CO 1M	342	TAŚMA LED AQUA PREMIUM	362
KULKI BAWELNIANE LED 60	297	KURTYNY LED 5X1M PRO	318	PROFESJONALNY WĄŻ LED NK1 ODGINEK TEST. 2 M	343	TAŚMA LED AQUA STANDARD	363
GWIAZDA DREWNIANA LED Z PILOTEM 40 CM	298	KURTYNY LED 2,5X1,5M PRO	318	WĄŻ ŚWIETLNY LED NEON PRO NK1	344	TAŚMA LED STANDARD	363
GWIAZDA DREWNIANA LED Z PILOTEM 60 CM	298	KURTYNY LED 2X2M PRO	319	WĄŻ ŚWIETLNY LED NEON PRO NK1 12V	344		
GWIAZDA DREWNIANA LED Z PILOTEM 50 CM	298	KURTYNY LED 2,5X3M PRO	319	GIRLANDA NA ŻARÓWKI E27 PRO 10 CZARNA	351		
GWIAZDA DREWNIANA LED Z PILOTEM 30 CM	299	KURTYNY LED 2,5X6M PRO	320	GIRLANDA NA ŻARÓWKI E27 PRO 20 CZARNA/BIAŁA	351		





WZDT CZĘSTOCHOWA
 ul. Przemysłowa 1, 41-500 Głycza

POŚWIADCZENIE

Miejscowy Zarząd Drog i Transportu w Częstochowie informuje, że

POLAMP Sp. z o.o.
 ul. Przemysłowa 1
 41-500 Głycza

zrealizowała w ramach zamówień publicznego Elementów świetlnych dekoracji i iluminacji świetlnych w skali miasta Częstochowa.

Referat Gospodarki Komunalnej i Ochrony Środowiska i Rozwoju Lokalnego i Ochrony Środowiska

ul. Przemysłowa 1, 41-500 Głycza

Władztwem, dnia 16.02.2014

POLAMP Sp. z o.o.
 ul. Przemysłowa 1
 41-500 Głycza

ZASWIADCZENIE nr WRGK/2014

Referat Gospodarki Komunalnej i Ochrony Środowiska i Rozwoju Lokalnego i Ochrony Środowiska w Głyczy

informuje, że firma POLAMP Sp. z o.o. z siedzibą w Głyczy

zrealizowała w ramach zamówienia publicznego Elementy dekoracji i iluminacji świetlnych w skali miasta Głycza w okresie zimowym 2013/2014

zrealizowała zamówienie na kwotę 141 011,20 zł.

w szczególności wykonała prace: zrealizowała prace: wykonanie i montaż elementów dekoracji i iluminacji świetlnych w skali miasta Głycza.

Niniejszym, rekomendujemy firmę POLAMP Sp. z o.o. jako firmę godną zaufania i odpowiedzialną za dotrzymanie terminów i jakości wykonanych prac.

Podpisany: Jacek Polak, kierownik referatu gospodarki komunalnej i ochrony środowiska

ENERGA | oświetlenie

GMINA MYSZKÓW
 ul. Władysława 1A, 41-500 Głycza
 tel. 77 46 12 12-20-42, fax 77 46 12 12-44
 www.gmina-myszkow.pl, biuro@gmina-myszkow.pl
 NIP: 770-10-01-010, REGON: 142398777

Myszków 19.04.2014

REFERENCJE

POLAMP Sp. z o.o.
 ul. Przemysłowa 1
 41-500 Głycza

BURMISTRZ MIASTA
 ul. Władysława 1A, 41-500 Głycza

REFERENCJE

Dla firmy POLAMP Sp. z o.o. z Głycza, wykonano i zrealizowano prace: zrealizowała prace: wykonanie i montaż elementów dekoracji i iluminacji świetlnych w skali miasta Głycza.

Niniejszym, rekomendujemy firmę POLAMP Sp. z o.o. jako firmę godną zaufania i odpowiedzialną za dotrzymanie terminów i jakości wykonanych prac.



Our customers:

commune and municipal offices:

- ALEKSANDRÓW ŁÓDZKI
- ANDRESPOL
- BARANÓW SANDOMIERSKI
- BARCZEWO
- BARTOSZYCE
- BIALA PISKA
- BIAŁOGARD
- BISZTYNEK
- BOBOLICE
- BOGATYNIA
- BOJANÓW
- BRANIEWO
- BRAŃSK
- BRENNA
- BUDRY
- BYDGOSZCZ
- BYTOM
- BYTÓW
- CEWICE
- CHMIELNIK
- CHOCIWEL
- CHOROSZCZ
- CIĘŻKOWICE
- CZECHOWICE-DZIEDZICE
- CZĘSTOCHOWA
- CZŁUCHÓW
- DĄBROWA BIAŁOSTOCKA
- DĄBROWA TARNOWSKA
- DĘBRZNO
- ELBLĄG
- EŁK
- GIŻYCKO
- GŁOGÓWEK
- GOŁDAP
- GOSTYŃ
- GÓRA KALWARIA
- GRAJEWO
- GRODZISK MAZOWIECKI
- HAJNÓWKA
- HEL
- IMIELIN
- JANIKOWO
- JAROCIN
- JASŁO
- JELCZ-LASKOWICE
- KALININGRAD
- KĘPICE
- KĘTRZYN
- KOLBUSZOWA
- KOLNO
- KOLONOWSKIE
- KOLUSZKI
- KONIN
- KORFANTÓW
- KORSZE
- KOSTKOWO
- KRAPKOWICE
- KRASNYSTAW
- KRYŃKI
- KRZESZOWICE
- KUDOWA-ZDRÓJ
- KWIDZYN
- LIBIĄZ
- LIDZBARK
- LIMANOWA
- LINIEWO
- LUBARTÓW
- LUBAWA
- LUBIN
- LUBLIN
- ŁĘBA
- ŁOMŻA
- ŁUKÓW
- ŁYSE
- MAKÓW MAZOWIECKI
- MARKI
- MIKOŁAJKI
- MIKOŁÓW
- MILANÓWEK
- MILKI
- MIŁOMŁYŃ
- MŁYNARY
- MRAGOWO
- MYSZKÓW
- NIEMCE
- NIEMCZA
- NIEMODLIN
- NISKO
- NOWOGRÓD
- NOWY TARG
- NOWY TOMYŚL
- OLECKO
- OLSZTYN
- ORZYSZ
- OSTRÓDA
- OŚWIĘCIM
- OTWOCK
- PASŁĘK
- PIECKI
- PIENIĘŻNO
- PIOTRKÓW TRYBUNALSKI
- PISZ
- PNIEWY
- POLANCUK
- POLKOWICE
- POŁANIEC
- POŚWIĘTNE
- POZNAŃ
- PRABUTY
- PROSTKI
- PRUSZCZ GDAŃSKI
- PRZECLAW
- PRZEMYSŁ
- RACIBÓRZ
- RAJGRÓD
- RAWA MAZOWIECKA
- RESZEL
- RUDA ŚLĄSKA
- RYGLICE
- RYN
- RYPIN
- SEJNY
- SEROCK
- SIENIAWA
- ŚLUPSK
- SOKÓŁKA
- SOSNOWIEC
- SUCHA BESKIDZKA
- SUSZ
- SUWAŁKI
- SWARZĘDZ
- SYCÓW
- SZAMOCIN
- SZCZAWNO-ZDRÓJ
- SZCZECIN
- SZCZUCZYN
- SZEPIETOWO
- SZTUM
- ŚMIGIEL
- ŚNIADOWO
- ŚRODA ŚLĄSKA
- ŚWIEBODZICE
- ŚWIECIE
- TARNOBRZEG
- TOLKMICKO
- TRZEMESZNO
- TUCHOLA
- USTRZYKI DOLNE
- WAŁBRZYCH
- WARKA
- WĄBRZEŻNO
- WĘGORZEWO
- WIELUN
- WŁADYSŁAWOWO
- WŁODAWA
- WŁOSZCZOWA
- WODZISŁAW ŚLĄSKI
- WOŁOMIN
- WYDMINY
- ZAMBROW
- ZAWICHOST
- ZĄBKOWICE ŚLĄSKIE
- ZGORZELEC
- ZIELONA GÓRA
- ŻELECHINEK
- ŻUKOWO

Companies and institutions:

- BACHLEDA S.A.
- ENERGA S.A.
- GH TU I TERAZ
- GRUPA HURTOWNI
- INTER-ELEKTRO S.A.
- JSW S.A.
- KOPEL S.A.
- LCP Properties Sp.z o.o.
- MZDIT Częstochowa
- OBI S.A.
- PASAŻ MURAŃW
- PGE S.A.
- POLSKI CUKIER S.A.
- SOLBET sp. z o.o.
- VECTRA S.A.
- WOJSKO POLSKIE
- ZDiSK Czerwonka-Leszczyni

Wholesalers:

- ALFA-ELEKTRO
- ELEKTRO-HOLDING
- EL-MEGA
- EL-SIGMA
- FORUM-RONDO S.A.
- GRODNO S.A.





SEE OUR OFFER FOR MORE DETAILS
ON EASTER DECORATIONS
LIGHT SOURCES, AND DISTRIBUTION BOARDS

ZAPRASZAMY DO ZAPOZNANIA SIĘ
Z NASZĄ OFERTĄ DEKORACJI
WIELKANOCNYCH, PATRIOTYCZNYCH
ŹRÓDEŁ ŚWIATŁA I ROZDZIELNIC ELEKTRYCZNYCH



POLAMP Sp. z o.o.

11-500 Giżycko, ul. Przemysłowa 1, POLAND
tel. +48 87 444 04 00

www.polamp.com

www.polampy.pl

NIP 845-165-91-42 REGON 790359841 KRS 0000187678

All copyrights are the property of Polamp LLC having its business office in Giżycko. Copying and use of graphic and textual materials or visualisations included in the catalogue w/out permission is prohibited. Dimensions, power consumption, and other technical data of particular products in the catalogue may vary from the factual ones.

Wszelkie prawa autorskie należą do firmy Polamp Sp. z o.o. z siedzibą w Giżycku. Zabrania się kopiowania i wykorzystywania bez zezwolenia zawartych w katalogu materiałów graficznych, tekstowych i zdjęć produktów. Wymiary, pobór mocy i inne dane techniczne poszczególnych produktów w katalogu mogą się nieznacznie różnić od rzeczywistych.